



REMEDIAL ACTION REPORT

ABC Barrel Company Site
308-322 North Front Street
Camden, New Jersey

April 19, 2018

Prepared For:

City of Camden Redevelopment Agency
520 Market Street
City Hall – Suite 1300
Camden, New Jersey 08101-5120

Prepared By:

BRS, Inc.
PO Box 2293
Medford Lakes, New Jersey 08055
Telephone: 856-964-6456 | Fax: 732-782-0404

Prepared by:

Charles V. Metzger, LSRP
License No. 668158

Reviewed by:

Kevin McAllister, PG, LSRP
License No. 668731

www.brsinc.com

TABLE OF CONTENTS

Executive Summary.....	1
1.0 Introduction	3
2.0 Site Background	3
2.1 Property Description	3
2.2 Site History	4
2.3 Historical Investigation and Remediation Activities	5
2.3.1 Summary of Regulatory Reports and Major Milestones	5
2.3.2 Area of Concern Summary	6
2.3.3 Remedial Action Workplan	10
2.3.3.1 AOC-B2 – 1,000-gal Heating Oil UST	11
2.3.3.2 AOC-G – Floor Drains/Trenches/Piping	11
2.3.3.3 HFM in Residential Unrestricted Use Areas	11
2.3.3.4 HFM in Non-Residential Restricted Use Area.....	11
2.3.3.5 RAW Deviations	12
3.0 Geology and Hydrogeology.....	12
3.1 Geology	12
3.2 Regional and Site Hydrogeology	13
4.0 Remedial Actions	13
4.1 Public Notification.....	13
4.2 Monitoring Well Closure	13
4.3 AOC-B2 (Former 1,000-gallon Fuel Oil UST)	14
4.4 AOC-G (Former Drain/Trench/Piping Area)	14
4.5 Disposal of Excavated Historic Fill Material	15
4.6 Future Residential Parcels.....	15
4.6.1 Post-Excavation Sampling Frequency	15
4.6.2 Remediation area RA-1 (PI No. 769626)	15
4.6.3 Remediation area RA-2 (PI No. 769654)	16
4.6.4 Remediation area RA-3 (PI No. 769582)	16
4.7 Future restricted use area (PI No. 006594).....	16



4.7.1	Open Space Area	16
4.7.2	Centennial Avenue	16
4.7.3	Deed Notice.....	17
4.8	Concrete Sampling and Disposal.....	17
4.9	Backfill Material and Restoration.....	18
5.0	Post-Excavation Sampling and Data Evaluation.....	18
5.1	AOC-B2 (Former 1,000-gallon Fuel Oil UST)	19
5.2	AOC-G (Former Drain/Trench/Piping Area)	19
5.3	Future Residential Parcels.....	19
5.4	Sample Handling and Data Reliability	20
6.0	Site Wide Groundwater (AOC-U)	20
7.0	Receptor Evaluation.....	21
7.1	Land Use.....	21
7.2	Groundwater.....	21
7.3	Vapor Intrusion	22
7.4	Ecological	22
8.0	Conclusion.....	23

Figures

- Figure 1** **Site Location**
- Figure 2** **Site Overview**
- Figure 3** **Remediation Areas**
- Figure 4** **AOC-B2 Post-Excavation Sample Locations**
- Figure 5** **AOC-G Post-Excavation Sample Locations**
- Figure 6** **Residential Post-Excavation Sample Locations**
- Figure 7** **Cross-Section of Capped Areas**
- Figure 8** **Topsoil Sample Locations**
- Figure 9** **Surrounding Land Use**
- Figure 10** **Surrounding Groundwater Use**



Tables

Table 1	Soil Sampling Summary
Table 2	Concrete Debris Analytical Results
Table 3	Topsoil Analytical Results
Table 4	Post-Excavation Results for AOC-B2
Table 5	Post-Excavation Results for AOC-G
Table 6	Post-Excavation Results for Unrestricted Use Areas
Table 7	Surrounding Land Use

Appendices

Appendix A	NJDEP Correspondence and Approvals
Appendix B	Public Notification
Appendix C	Material Disposal Documentation
	C-1 Contaminated Soil Disposal
	C-2 Historic Fill Disposal
	C-3 Contaminated Concrete Disposal
	C-4 Concrete Recycling
Appendix D	Centennial Avenue
Appendix E	Deed Notice
Appendix F	Laboratory Reduced Deliverables
Appendix G	Clean Fill Documentation
Appendix H	Third-Party Data Review



EXECUTIVE SUMMARY

This RAR summarizes remedial actions performed at the Site from February to April 2017. The work was completed in accordance with a November 2011 Remedial Action Workplan (RAW) that was approved by the New Jersey Department of Environmental Protection (NJDEP) on 1/24/12.

The remediation was conducted in accordance with the *Technical Requirements for Site Remediation* (N.J.A.C. 7:26E / TRSR); *Administrative Requirements for the Remediation of Contaminated Sites* (N.J.A.C. 7:26C / ARRCs); *Site Remediation Reform Act* (N.J.S.A. 58:10C-1 et seq. / SRRA); and NJDEP Technical Guidance Documents.

The Site has been used for industrial and manufacturing purposes since before 1885. Starting in 1977, drum refinishing operations were conducted, including cleaning, reshaping and painting. The site became owned by the City of Camden via foreclosure in November 1996. Title to the property was subsequently transferred to the City of Camden Redevelopment Authority (CRA) in February 2004. The CRA is the current property owner.

Various investigation activities were conducted from 1996 to 2010, which discovered releases associated with multiple Areas of Concern (AOCs). In addition, historic fill material was identified across the site. Four monitoring wells were installed to investigate groundwater. A 2009 groundwater investigation report indicated that groundwater was compliant with the Ground Water Quality Criteria (GWQC) and a No Further Action (NFA) determination for groundwater was subsequently issued.

Multiple prior remedial activities were conducted from 2000 to 2006, including a USEPA Removal Action that removed drummed waste and excavated lead contaminated surface soil from the site. Subsequent remedial activities successfully addressed all but three of the AOCs, however none of the work resulted in NFA determinations from NJDEP.

Plans were made for future redevelopment of the site to include ten (10) residential parcels along the perimeter, and a non-residential common area in the central portion, which was designed to include parking, access roadways, and a public park. In 2011, a Remedial Action Workplan was prepared to remediate the final three AOCs at the site:

- AOC-B2 – 1,000-gal Heating Oil UST
- AOC-G – Floor Drains/Trenches/Piping
- AOC-T – Site-Wide Historic Fill

Three groups of parcels were subdivided from the site for future residential redevelopment, resulting in changes to parcel numbering and street addresses. In addition, new Site Remediation Program (SRP) Program Interest (PI) numbers were created for each of the three areas planned for future residential use. This report discusses remedial activities for all SRP sites that comprise the former ABC Barrel Site – three new SRP sites planned for future residential use, along with the original SRP site which is planned as the future non-residential common area.



In 2017, the CRA conducted remediation activities at the site. Soil associated with AOC-B2 and AOC-G were excavated for off-site disposal. Post-excavation soil sample results were compliant with NJDEP Residential Direct Contact Soil Remediation Standards (RDCSRS).

Soil associated with AOC-T was remediated using a combination of methods. In areas planned for future residential use, all historic fill material was excavated for off-site disposal. A post-excavation soil sample was collected from the base of each cavity and the results were compliant with RDCSRS. In the central portion intended for non-residential use, historic fill material was excavated from the surface to a depth of 2 feet, and a 2 ft thick clean fill cap was constructed. In addition, a Deed Notice was recorded for this area to prevent future residential use.

The GWQC was changed in the time since the previous groundwater samples were collected. In addition, the prior lab data are not available for review. As a result, a Classification Exemption Area (CEA) is being established for potential impacts from historic fill material.

Concurrent with this report, a Remedial Action Permit (RAP) application is being submitted to the NJDEP for the non-residential common area. Following establishment of the CEA and issuance of the RAP, the LSRP will issue the following Response Action Outcomes (RAOs):

- PI No. 006594 (Non-residential) – Restricted RAO-A for soil and limited-restricted RAO-E for groundwater
- PI No. 769654 (Residential) – Unrestricted RAO-A for soil and limited-restricted RAO-E for groundwater
- PI No. 769582 (Residential) – Unrestricted RAO-A for soil and limited-restricted RAO-E for groundwater
- PI No. 769626 (Residential) – Unrestricted RAO-A for soil and limited-restricted RAO-E for groundwater



1.0 INTRODUCTION

On behalf of the City of Camden Redevelopment Authority (CRA), Brownfield Redevelopment Solutions, Inc. (BRS) has prepared this Remedial Action Report (RAR) for the ABC Barrel Company Site (a.k.a. AABCO Steel Drum, a.k.a. North Front St Associates, a.k.a. Container Recyclers). The location of the site is depicted on **Figure 1**.

This RAR summarizes remedial actions performed at the Site from February to April 2017. The work was completed in accordance with a November 2011 Remedial Action Workplan (RAW) that was approved by the New Jersey Department of Environmental Protection (NJDEP) on 1/24/12.

The remediation was conducted in accordance with the *Technical Requirements for Site Remediation* (N.J.A.C. 7:26E / TRSR); *Administrative Requirements for the Remediation of Contaminated Sites* (N.J.A.C. 7:26C / ARRCs); *Site Remediation Reform Act* (N.J.S.A. 58:10C-1 et seq. / SRRRA); and NJDEP Technical Guidance Documents.

2.0 SITE BACKGROUND

2.1 Property Description

The Site was identified in prior reports as Block 62, Lots 38 and 45, with an address of 308-322 North Front Street, in the City of Camden, Camden County, New Jersey. Subsequent subdivision block and lot information as well as the current City of Camden Tax Assessor block and lot information for the property is summarized in the table below.

The footprint of the entire ABC Barrel site measures 1.1 acres in area. The site is bordered to the north by residential properties; to the south by Centennial Avenue and residential properties; to the east by N. Second Street; and to the west by N. Front Street. The surrounding area is an urban, mixed use residential and commercial neighborhood.

Three groups of parcels were subdivided from the site for future residential redevelopment, resulting in changes to parcel numbering and street addresses. To accommodate both restricted and unrestricted use, the site was also split into multiple Site Remediation Program (SRP) Program Interest (PI) numbers. The table below identifies the regulatory tracking information and parcels:

Program Interest Name	NJDEP Identification Numbers	Address / Area	Current City Tax Assessor's Block/Lot	Plan of Site Block/Lot
Centennial Avenue Park	NJEMS Site ID 60259 SRP PI 006594 and Case No. 95-09-14- 1206-53	Centennial Ave /0.50 acres	None	None



Program Interest Name	NJDEP Identification Numbers	Address / Area	Current City Tax Assessor's Block/Lot	Plan of Site Block/Lot
Front Street Property	NJEMS Site ID 610510 PI No. 769654	324-330 N Front St /0.22 acres	Block 62.01 Lots 1, 2, 3 and 4	Block 62.01 Lots 1, 2, 3 and 4
Penn Street Property	NJEMS Site ID 610486 PI No. 769582	121-123 Penn St /0.07 acres	Block 62.02 Lots 24 and 25	Block 62 Lots 24 and 25
North Second Street Property	NJEMS Site ID 610495 PI No. 769626	315-309 N Second St / 0.31 acres	Block 62 Lots 17, 21, 22 and 23	Block 62 Lots 17, 18, 19 and 20

2.2 Site History

The Site has been used for industrial and manufacturing purposes since before 1885. From 1906 to 1977, the Standard Tank and Seat Company manufactured wooden toilet seats. Thereafter, drum refinishing operations were conducted at the site, first by Pertnoy Drums, Inc., then AABCO Steel Drum, Inc. and finally by Container Recyclers, Inc. Prior to 1977, three buildings existed at the site. Between 1977 and 1982, one of the buildings in the center of the property was demolished, leaving an open courtyard in its former location.

Drum refinishing operations including cleaning, reshaping and painting. The facility reportedly only accepted drums that could be cleaned using a caustic soda process and all operations were conducted indoors. Residual drum contents were initially collected in waste drums and later in a waste oil tank. The caustic soda rinse was reportedly pretreated to adjust pH, then passed through an oil-water separator where sludge and oils were removed. The remaining fluids were discharged to the sanitary sewer in accordance with a Camden County Municipal Utilities Authority discharge permit, although it has been reported that the effluent consistently failed to meet the permit requirements.

The paint applied to the drums was reportedly water-based. Generated waste from the reconditioning processes included residual drum contents and rinse water from the drum washing activities.

In 1987, AABCO changed its name to Container Recyclers and reportedly only used the site for storage of clean drums.

In 1995, NJDEP Case No. 95-09-14-1206-53 was generated for the site. It appears that this number is not the result of a new or prior discharge at the site, but rather was generated following the submission of a Memorandum of Agreement. A copy of the NJDEP Communications Center Notification Report is attached in **Appendix A**.

The site became owned by the City of Camden via foreclosure in November 1996. Title to the property was subsequently transferred to the CRA in February 2004. The CRA is the current property owner.



2.3 Historical Investigation and Remediation Activities

A brief summary of the investigation and remediation activities conducted at the site is included below. A summary of each AOC is included below in Section 2.3.2.

2.3.1 Summary of Regulatory Reports and Major Milestones

After the City took ownership of the property in 1996, Remington & Vernick Engineers (RVE) of Haddonfield, New Jersey, conducted a Preliminary Assessment (PA) at the site. RVE's December 1996 PA Report identified 19 Areas of Concern (AOCs). At the time, the site consisted of two buildings and open yard areas, as shown on **Figure 2**.

Thereafter, a Site Investigation (SI) was conducted to investigate 11 of the AOCs identified in the PA. The SI also identified a previously unknown underground storage tank (UST) at the site. This work also included investigation of groundwater. RVE documented the SI results in an April 1999 SI Report.

In June of 2000, the United States Environmental Protection Agency (USEPA) initiated a CERCLA Removal Action at the site. Approximately 750 tons of lead-contaminated soil was excavated from 0 – 2 ft deep and disposed off-site. In addition, a limited volume of drummed hazardous and non-hazardous wastes were removed from the site.

In 2001, RVE undertook Remedial Investigation (RI) activities. A total of eight AOCs were investigated, including groundwater. RVE documented the RI results in an October 2002 RI report.

In October of 2003, a contractor working on behalf of the City of Camden Redevelopment Authority (CRA) demolished the buildings that were located at the site. Thereafter, EHS Environmental, Inc., of Mullica Hill, New Jersey, was retained by a prospective developer to decommission a 8,000-gallon diesel fuel UST. In addition, EHS conducted remediation at several AOCs at the site. This work was completed in February 2005 and documented in a February 2006 SI report.

In March of 2006, additional soil remediation was conducted at the site by React Environmental Professional Services Group (REPSG) of Philadelphia, Pennsylvania. No reports were submitted by REPSG for these activities.

In 2008, Dresdner Robin (DR) of Jersey City, New Jersey, was retained by the CRA. DR conducted a groundwater investigation, which included reconstruction and inspection of three previously installed wells (MW-1 through MW-3) and installation and sampling of MW-4. Based on the results, DR submitted a March 2009 Groundwater Remedial Investigation Letter Report to NJDEP requesting No Further Action (NFA) for groundwater. Thereafter, NJDEP issued a groundwater NFA on 9/30/10.

In July 2010, DR submitted a Supplemental Remedial Investigation Report / Historical Remedial Action Report (RIR/RAR). This report provided responses to prior NJDEP comments on the 2002 RI report and described remediation activities conducted by REPSG in 2005-2006. The report was approved by NJDEP on 9/30/10 and a copy of the approval letter is included in **Appendix A**.



2.3.2 Area of Concern Summary

The AOCs identified by the 1996 PA/SI activities, are discussed below. The nomenclature and grouping of AOCs mirrors the prior reports for consistency. The discussion for each AOC includes the LSRP's conclusion regarding the necessity for additional investigation or cleanup.

- *AOC-A1 – Above Ground Waste Oil Tank*

This tank collected residue from the drums prior to cleaning. The vessel was situated above a concrete floor that was in good condition. No further investigation is required.

- *AOC-A2 – Above Ground Water Treatment Tank*

This tank was used for pH adjustment of the caustic soda wash water prior to discharge to the sanitary sewer. During the SI, soil samples were collected in the former tank location, results of which were below the most stringent cleanup criteria. No further investigation is required.

- *AOC-B1 – 8,000-gal Diesel Fuel UST (Also identified in prior reporting as AOC-004)*

This tank was registered as a 1,000-gal UST (UST No. 0065946). During the SI, it was observed that the vessel was likely larger than 1,000-gal. Borings were installed and soil samples evidenced Total Petroleum Hydrocarbons (TPH) above NJDEP criteria. During the RI, the horizontal and vertical extent of soil contamination was delineated. In addition, groundwater was investigated and is described in AOC-U. The vessel was removed in February 2005 (Closure No. C04-3522). Post-removal soil samples were collected and were reportedly compliant with NJDEP criteria. However, 667 cubic yards (cy) of underlying soil was subsequently excavated (identified as AOC-004) and disposed. Post-excavation samples were collected and did not exceed the NJDEP criteria. No further investigation or remediation is required.

- *AOC-B2 – 1,000-gal Heating Oil UST*

This unregulated tank stored heating oil for on-site use and was discovered during the SI. Soil samples were collected from around the vessel which did not evidence contamination. The vessel was removed in February 2005, however post-removal soil samples were not collected. Instead of returning to the site to collect tank closure samples, the City elected to excavate the former tank cavity and collect post-excavation samples. This work is described in Section 4.3, below. Based on the sample results, no further investigation or remediation is required.

- *AOC-B3 – 1,000-gal Waste Water UST (Also identified in prior reporting as AOC-005)*

This tank collected liquid from the drum rinse/wash operations and was discovered during the SI. Soil samples were collected from around the vessel, which evidenced impacts above NJDEP criteria. During the RI, the horizontal and vertical extent of soil contamination was delineated. Contaminants of concern in this AOC included TPH, metals, Volatile Organic Compounds (VOCs) and Base Neutral (BN)



compounds. In addition, groundwater was investigated and is described in AOC-U. In February 2005, the UST was removed and approximately 70 cy of underlying soil was excavated (identified as AOC-005) and disposed. Post-excavation samples were collected and did not exceed the NJDEP criteria. Because it was previously unregistered, the vessel was registered and assigned Closure No. C04-3522. No further investigation or remediation is required.

- *AOCs-C1, C2, C3, C4 & C5 – Pits in Building 1 (Also identified in prior reporting as AOC-002)*

These were indoor process pits that were located in the north-central part of Building 1. They were recessed into the concrete floor in the drum refinishing areas. Sediment within the pits (if present) was sampled and generally contained metals and BN compounds. Soil beneath the pits was also sampled. Soil beneath AOC-C5 was below the NJDEP criteria. Soil beneath the remaining pits evidenced metals, BNs, and/or chlorinated volatile organic compounds (cVOCs). During the RI, the horizontal and vertical extent of soil contamination was delineated (with the exception of lead, which is attributed to HFM). In March 2006, approximately 240 cy of soil was excavated (identified as AOC-002) and disposed. Post-excavation samples were collected and did not exceed the NJDEP criteria. No further investigation or remediation is required.

- *AOC-C6 – Pit in Building 2 (Also identified in prior reporting as AOC-Cc and AOC-006)*

This pit was located in the northwest corner of Building 2. It was recessed into the concrete floor and its purpose is unknown. No liquid or sediment was observed within the pit during PA or SI activities. Soil beneath the pit was sampled and evidenced metals and BN compounds. During the RI, the horizontal and vertical extent of soil contamination was delineated. In March 2006, approximately 56 cy of soil was excavated (identified as AOC-006) and disposed. Post-excavation samples were collected and did not exceed the NJDEP criteria. No further investigation or remediation is required.

- *AOC-D1, D2, D3 and K – Loading docs*

These were loading docks that were located outside the buildings. Samples from the vicinity of AOC-D1 & D2 identified metals and PAH compounds. AOC-D3 was not investigated separately as this AOC is collocated with AOC-B1 & O. These impacts will be addressed as part of the remedy for site-wide HFM. Therefore, no further investigation or remediation of this AOC is required.

- *AOC-E & M – Drum Storage Area/Yard Area*

This is a pervious area of the site between buildings where drums are reported to have been stored. A third building previously located in this area was demolished between 1977 and 1982. During SI activities, this area was gridded into approximately 30 ft by 30 ft sections and sampled. The results of soil sampling indicated PAH and metals impacts above NJDEP criteria across the entire yard. In addition, groundwater was investigated and is described in AOC-U. Soil and groundwater impacts in this area are



attributable to HFM and will be addressed as part of the remedy for site-wide HFM. Therefore, no further investigation or remediation of this AOC is required.

- *AOC-F – Chemical Storage Cabinet*

This area stored solvent for use at the site. It was situated above a concrete floor that was in good condition. No further investigation is required.

- *AOC-G – Floor Drains/Trenches/Piping (Also identified in prior reporting as AOC-006)*

This AOC includes a floor drain, a 150 ft long trench and a 4-inch diameter pipe extending adjacent to the southern wall of Building 1. This system was used to convey drum rinsing/washing liquids (AOC-C1-C5) from the oil/water separator (AOC-O) to the public sewer. During the SI, a sample from inside a floor drain pipe identified TPH, phenols, VOCs and semi-volatiles (SVOCs). Soil samples collected from beneath the trench and pipe identified TPH, metals and SVOCs. During the RI, the horizontal and vertical extent of soil contamination was delineated (with the exception of lead, which is attributed to HFM). In March 2006, approximately 265 cy of soil was excavated (identified as AOC-006) and disposed. Post-excavation samples were collected. Of the 10 samples that were collected, 9 were compliant with NJDEP criteria; one, identified as 06-PE-006, exhibited a slight exceedance for tetrachloroethylene (PCE). Compliance averaging techniques could have demonstrated compliance with NJDEP regulation, however the City elected to advance the excavation to remove soil associated with the PCE exceedance. This work is described in Section 4.4, below. Based on the post-excavation results, no further investigation or remediation is required.

- *AOC-H – Roof Leaders*

The roof leaders discharged into the sanitary sewer. No further investigation is required.

- *AOC-I – Underground Piping*

Underground piping was addressed as part of AOCs B, C, G and O. No further investigation is required as part of this AOC.

- *AOC-J – Discolored Areas/Spill Areas*

Staining was observed on a small section of concrete flooring due to repeated automobile oil changes. The concrete floor was in good condition. No further investigation is required.

- *AOC-L – Boiler room*

The concrete floor beneath the boiler was in good condition with little staining. The fuel conveyance piping is being addressed as part of AOC-B2. No further investigation is required.



- *AOC-M – Hazardous material storage or handling areas*

Three observed hazardous material storage areas (Drum storage, Solvent storage and Paint Booth) are being addressed as separate AOCs (AOC-E, F & N). No further investigation is required as a part of this AOC.

- *AOC-N – Paint Booth*

This AOC is a mobile paint booth that was used within the east side of Building 1. Disposable tarps were reportedly placed beneath the spray booth during its use and no signs of discharge were noted in the PA. No further investigation is required.

- *AOC-O – Oil/Water Separator and Associated Piping (Also identified in prior reporting as AOC-001)*

The oil/water separator was reportedly located in the yard area. During the SI, 6 soil samples were collected within the area of the separator and all exhibited TPH concentrations above criteria. During the RI, the horizontal and vertical extent of soil contamination was delineated. In addition, groundwater was investigated and is described in AOC-U. In March 2006, approximately 20 cy of soil was excavated (identified as AOC-001) and disposed. Post-excavation samples were collected and did not exceed the NJDEP criteria. No further investigation or remediation is required.

- *AOC-P1 – Elevator in southwest corner of Building 1*

Local interviews suggested that spent solvents had been disposed into the elevator pit. Test pits were installed alongside the elevator shaft. Soil samples were tested, but only lead exceeded the criteria, which is attributable to HFM. These impacts will be addressed as part of the remedy for site-wide HFM. Therefore, no further investigation is required.

- *AOC-P2 – Elevator in northeast side of Building 1*

Local interviews suggested that spent solvents had been disposed into the elevator pit. Standing liquid inside the pit was sampled, however results were well below the GWQC. Test pits were installed alongside the elevator shaft. Soil samples were tested and were compliant with the soil criteria. No further investigation is required.

- *AOC-Q and AOC-R – Lead-based paint and Asbestos*

These two AOCs are associated with building materials inside the structure. Neither presented evidence of a release to the environment. Sampling of potential asbestos-containing material (ACM) confirmed the presence of asbestos. Testing of painted surfaces did not meet the definition of lead-based paint. When the buildings were demolished in 2003, these AOC were removed from the site. No further investigation is required.



- *AOC-S – Non-Contact Cooling Water Discharge Areas*

A rooftop water tank existed atop a building that was demolished between 1977 and 1982. The former building location is the same as the yard area of the site, which was investigated under AOC-E&M. No further investigation is required as part of this AOC.

- *AOC-T – Historic Fill (not given an AOC designation in prior reports)*

Historic fill material (HFM) was encountered during SI activities at multiple AOCs. As a result, a boring was installed in each of the corners of the property during the RI. HFM was observed up to 12 ft bgs. In addition, groundwater was investigated and is described in AOC-U. Remediation of HFM is discussed in Sections 4.6 and 4.7 of this report. Based on post-excavation sample results, and implementation of engineering and institutional controls documented herein, no further investigation or remediation is required.

- *AOC-U – Site Wide Groundwater (not given an AOC designation in prior reports)*

Between 1998 and 2008, four groundwater monitoring wells (MW-1 through MW-4) were installed in the vicinity of AOC-B1, B2, B3, C1-C5, E, G, M, O and T. Samples collected from each of the wells via low-flow techniques were compliant with the GWQC. A groundwater RIR was submitted in 2009 and an unrestricted NFA for groundwater was issued in 2010. The old data is unavailable for order of magnitude review, and the analyses are likely insufficient to compare to current standards. Therefore, a virtual CEA is being established with this RAR. Details of AOC-U are further discussed in Section 6.0 of this report. No further investigation or remediation is required.

- *Block 65, Lot 103*

This AOC was previously associated with the subject site. The parcel is 320 N. Second Street, which was owned by North Front Associates, who also owned the subject site. The PA reported that the parcel was vacant, was previously used for a residence, and that no operations were conducted there. That parcel is currently known as SRP PI No. 711337. Therefore NJDEP's database was updated to move this AOC from PI No. 006594 to PI No. 711337. No further investigation is required as part of the subject site.

2.3.3 Remedial Action Workplan

Following a comprehensive review of the case file, and submittal of the 2010 RIR/RAR, DR prepared a November 2011 Remedial Action Workplan (RAW) for the site. Future intentions are to redevelop the site to include ten (10) residential parcels along the perimeter, and a common area in the central portion, which is planned to include parking, access roadways, and a public park. The future residential parcels were grouped into three remediation areas (RA-1, RA-2 and RA-3), as depicted on **Figure 3**. The table in Section 2.1 above describes details for the different remediation areas.

The RAW specified retaining a NJ-licensed well driller to seal the 4 monitoring wells located at the site. In addition, the RAW requested authorization for a Discharge to Groundwater / Permit-by-Rule



(DGW/PBR) authorization to discharge any groundwater that infiltrated the excavation. Note that groundwater remediation was not included in the RAW because a NFA had previously been issued. The RAW and DGW/PBR were subsequently approved by NJDEP on 1/24/12 and copies of the approval letters are included in **Appendix A**.

Based on the RIR/RAR, the following three AOCs were addressed in the RAW:

- AOC-B2 – 1,000-gal Heating Oil UST
- AOC-G – Floor Drains/Trenches/Piping
- AOC-T – Site-Wide Historic Fill

2.3.3.1 AOC-B2 – 1,000-gal Heating Oil UST

The RAW proposed collecting 4 soil samples from the centerline of the former UST excavation in order to confirm the post-removal conditions. If sample screening identified impacts, then the contaminated soil would be fully delineated horizontally and vertically. Samples were to be analyzed for NJ Extractable Petroleum Hydrocarbons (EPH) with fractionation and contingent naphthalene and 2-methylnaphthalene. Thereafter, any contaminated soil would be excavated for off-site disposal and post-excavation samples would be tested.

2.3.3.2 AOC-G – Floor Drains/Trenches/Piping

The RAW proposed installing a total of 9 borings to delineate the extent of the PCE impacts associated with sample 06-PE-006. Samples would be analyzed for PCE. Thereafter, the contaminated soil would be excavated for off-site disposal and post-excavation samples would be tested.

2.3.3.3 HFM in Residential Unrestricted Use Areas

HFM was proposed to be fully excavated from the three future residential areas, so that soil would meet NJDEP Residential Direct Contact Site Remediation Standards (RDCSRS) for unrestricted use. These areas total 0.6 acres. The depth of excavation was anticipated to be approximately 12 ft bgs. The total volume estimated for removal was 10,783 cy. Thereafter, certified clean backfill would be installed and compacted to restore the site to grade.

2.3.3.4 HFM in Non-Residential Restricted Use Area

In the central public portion of the site, an engineering control (cap), institutional control (deed notice), and Soil Remedial Action Permit was proposed to prevent exposure to contaminants in excess of the NJDEP Non-Residential Direct Contact Site Remediation Standards (NRDCSRS). This area totals 0.5 acres. A portion of this area measuring 0.07 acre (900 ft²) was previously paved during the construction of Centennial Avenue, which serves as a cap. For the balance of this area, the RAW proposed excavating +/- 1 ft of historic fill from across the site for off-site disposal. Thereafter, a 2-ft thick cap of certified clean backfill would be installed and compacted.



2.3.3.5 RAW Deviations

The remedial actions performed at the Site included the following deviations from the approved RAW. Please note that these deviations did not reduce the protectiveness of the remedy.

- While the RAW specified (see section 2.3.3.1) sampling the base of the former tank cavity (AOC-B2), the property owner elected to excavate the former tank cavity and collect post-excavation samples. See Section 4.3 below for details.
- While the RAW specified (see section 2.3.3.2) delineating the impacts found in the prior post-excavation sidewall sample (AOC-G), the property owner elected to further advance the prior excavation and collect new post-excavation samples. See Section 4.4 below for details.
- The RAW did not specify (see section 2.3.3.3) collecting post-excavation base samples from the residential unrestricted use areas. However to ensure complete excavation, one post-excavation sample was collected. See Section 5.3 below for details.
- A NFA for groundwater at the site was issued in 2010. However, a virtual institutional control (Classification Exemption Area/CEA) was also implemented to prevent exposure to future potential groundwater impacts from HFM. See Section 6 below for details.

3.0 GEOLOGY AND HYDROGEOLOGY

3.1 Geology

Based upon the US Geological Survey Bedrock Geology Map of Central and Southern New Jersey, the subject site is underlain by the unconsolidated Lower Cretaceous Age Potomac Formation (Map Unit Kp3). The Potomac Formation in this area is composed of predominantly mottled red, white, and orange-brown clay to clay-silt, interbedded with thin beds and lenses of fine to medium grained micaceous sand. According to the New Jersey Geologic Survey's Periglacial Features of Southern New Jersey, surficial deposits underlying the study area consist of Pleistocene Age marine-estuarine terrace deposits of the Cape May Formation, characterized by less than 40 ft thick quartz sand and pebble gravel. These deposits are ringed by recent estuarine/marsh deposit associated with the Delaware River and adjoining estuary channels.

Shallow subsurface conditions encountered by DR were described in soil boring logs as follows:

- 0 to 6 feet- orange to red brown medium to fine sand and silt with little to some pieces of brick, concrete and miscellaneous debris, and gravel;
- 4 to 17 feet- dark gray medium to fine and coarse to fine sand, with little to some silt and gravel, and a trace of miscellaneous debris.

In another instance, DR also noted that natural materials were encountered at 17 ft that consisted of yellow-brown medium to fine sand with little silt and trace of quartz gravel.



3.2 Regional and Site Hydrogeology

Groundwater at the Site is expected to generally flow west/southwest towards the Delaware River, which is located approximately 1,500 ft west of the site. Due to the distance of the site to the Delaware River, groundwater levels are not expected to be influenced by tidal flow in the Delaware River channel.

During the supplemental investigations, depth to groundwater in the site monitoring wells varied from approximately 9 feet to 13 ft bgs. DR's July 2010 RIR/RAR presented a groundwater contour map as Figure 9, which depicted groundwater flow varying from northwesterly to southwesterly across the site. The quality of shallow groundwater in the vicinity of the site is expected to be generally poor due to widespread impacts from area-wide HFM as well as from more localized point sources of contamination. Properties in the vicinity of the site are provided public drinking water by the Camden City Water Department.

4.0 REMEDIAL ACTIONS

On behalf of the CRA, BRS prepared bid specifications for the required remedial activities. Based on the results of an open public bidding process, the CRA contracted in late 2016 with The Ambient Group, LLC, (Ambient) of Sewell, New Jersey. Prior to site mobilization, Ambient retained Consulting Engineer Services (CES) of Sicklerville, New Jersey, a NJ-licensed surveyor (License No. 24GS04335700) to identify the property boundaries so that temporary fencing and remedial excavations could be accurately located. On 2/15/17, site preparation activities began by implementing the controls required by the Soil Erosion and Sediment Control plan approved by the Camden County Soil Conservation District.

During remedial activities, Ambient was overseen full-time by a BRS-subcontracted monitor who reported directly to BRS' Construction Manager and LSRP. This individual visually identified the extent of HFM, ensured that Ambient performed in accordance with its contract, and documented site activities. Soil samples collected by Ambient and BRS during this remedial action are summarized on **Table 1**.

4.1 Public Notification

In March 2017, the property owner posted notification signs at the site in English and Spanish in accordance with NJDEP's public notification requirements. The Public Notification and Outreach Form is being submitted with this report. A copy of the form, a photograph of the sign, and copies of the required governmental letters are included in **Appendix B**.

4.2 Monitoring Well Closure

On 4/4/17, monitoring wells MW-1 through MW-4 were properly decommissioned by Scott Alberalla (License No. 0001087) of Advanced Drilling, Inc., of Hampton, New Jersey. Manholes were removed and the well casings were filled with hydrated bentonite and cement using a tremie pipe. This work was completed in accordance with the requirements of NJAC 7:9D, the Well Construction Rule. Copies of the NJDEP well decommissioning reports are provided in **Appendix A**.



4.3 AOC-B2 (Former 1,000-gallon Fuel Oil UST)

Because proper UST closure samples were not collected following the 2005 removal of this vessel, the RAW specified collecting the samples concurrent with the other planned remedial activities. However, to provide a more expedient resolution of this AOC, the property owner instead elected to over-excavate the former UST cavity and collect post-excavation samples.

On 2/28/17, Ambient excavated soil from the former UST cavity and stockpiled it on-site pending waste profiling and off-site disposal. The excavated soil was screened using a calibrated photoionization detector (PID) and did not evidence volatile vapors. The finished cavity measured 12 ft long, 12 ft wide, and 8 ft deep. Soil generally consisted of sand with silt, cobble, brick fragments and metal pieces. Fill dirt from the previous excavation of AOC-B1 was encountered. No groundwater was encountered during remedial activities.

Following excavation, soil samples were collected as detailed in Section 6.1. Thereafter, the cavity was backfilled with clean fill and compacted. Information regarding the backfill material is included in Section 4.9. The remediation area is depicted on **Figure 4**.

Excavated material was stockpiled pending waste classification by Ambient. On 3/27/17 and 3/28/17, a combined 134.43 tons of excavated soil from AOC-B2 and AOC-G was transported to the Cape May County Municipal Utilities Authority landfill in Woodbine, New Jersey, for disposal. Waste disposal documentation is included in **Appendix C-1**.

4.4 AOC-G (Former Drain/Trench/Piping Area)

Because prior post-excavation sample 06-PE-006 evidenced PCE concentrations in excess of the NJDEP criteria, the RAW specified delineating the extent of the residual impacts concurrent with the other planned remedial activities. However, to provide a more expedient resolution of this AOC, the property owner instead elected to advance the prior excavation and collect post-excavation samples.

On 3/1/17, Ambient excavated soil associated with sample 06-PE-006 and stockpiled it on-site pending waste profiling and off-site disposal. The excavated soil was screened using a calibrated PID and did not evidence volatile vapors. The finished cavity measured 12 ft long, 12 ft wide, and 6 ft deep. Soil generally consisted of sand with silt, with metal pieces and brick fragments. Significant wood and metal debris was encountered from 3 – 4 ft bgs. Based on observed orange fill dirt that was encountered, the cavity was advanced approximately 3 ft into the prior remediation area. No groundwater was encountered during remedial activities.

Following excavation, soil samples were collected as detailed in Section 6.2. Thereafter, the cavity was backfilled with clean fill and compacted. Information regarding the backfill material is included in Section 4.9. The remediation area is depicted on **Figure 5**.

Excavated material was stockpiled pending waste classification by Ambient. On 3/27/17 and 3/28/17, a combined 134.43 tons of excavated soil from AOC-B2 and AOC-G was transported to the Cape May



County Municipal Utilities Authority landfill in Woodbine, New Jersey, for disposal. Waste disposal documentation is included in **Appendix C-1**.

4.5 Disposal of Excavated Historic Fill Material

Historic fill material that was excavated from the site (as described below) was disposed at the Harrison Avenue Landfill (HAL / Sanitary landfill No. 133513). The HAL is located on Block 809, Lots 7-9 and Block 809.01, Lot 18 in Camden City, and is located approximately 1.5 miles from the subject site. The HAL is also owned by the CRA. This material was approved for use at the landfill pursuant to NJDEP's 7/22/15 Landfill Disruption Approval No. LCC090003, which is included in **Appendix A**. A total of 21,442.14 tons of HFM-contaminated soil was transported to the HAL for disposal. Non-hazardous waste manifests for this material is also included in **Appendix C-2**.

4.6 Future Residential Parcels

Three separate areas of the site, identified as RA-1, RA-2, and RA-3, were designated for future unrestricted use, as detailed in the 2011 RAW and shown on **Figure 3**. The remedial strategy selected for these areas was excavation all impacted historic fill material.

4.6.1 Post-Excavation Sampling Frequency

The NJDEP-approved 2011 RAW did not specify collection of post-excavation samples from the areas designated for unrestricted use. However, with agreement from the property owner, the LSRP collected one post-excavation base sample from each excavation area (i.e. RA-1, RA-2 and RA-3). This frequency was selected because: 1) HFM at the site is visually identifiable; 2) it has been well characterized; 3) high contaminant concentrations have not been identified; and 4) the contractor advanced the cavity approximately 1 foot deeper than the visual extent of the HFM. No sidewall samples were collected because HFM is present in the surrounding properties.

4.6.2 Remediation area RA-1 (PI No. 769626)

Between 2/20/17 and 3/30/17, Ambient excavated historic fill material from RA-1. The finished cavity measured 121 ft long by 115 ft wide. The cavity base was extended approximately 1 ft deeper than the observed limit of historic fill material. The final depth of the cavity in most areas was 12 ft bgs, however the western end of the cavity was advanced to 10 ft bgs. Excavated soil generally consisted of sand with silt, with metal pieces, wood, and brick fragments. No groundwater was encountered during remedial activities.

Thereafter, a post-excavation soil sample was collected from the cavity base in its deepest location. Immediately after excavation, the cavity was backfilled with clean fill and compacted. Information regarding the backfill material is included in Section 4.9. A total of 9,758 tons of excavated soil was transported to the nearby HAL site for disposal as described above in Section 4.5.



4.6.3 Remediation area RA-2 (PI No. 769654)

Between 2/20/17 and 3/17/17, Ambient excavated historic fill material from RA-2. The finished cavity measured 108 ft long by 90 ft wide. The cavity base was extended to 12 ft bgs, which was 1 ft deeper than the observed limit of historic fill material. Excavated soil generally consisted of sand with silt, with metal pieces, wood, and brick fragments. No groundwater was encountered during remedial activities.

Thereafter, a post-excavation soil sample was collected from the cavity base. Immediately after excavation, the cavity was backfilled with clean fill and compacted. Information regarding the backfill material is included in Section 4.9. A total of 8,056 tons of excavated soil was transported to the nearby HAL site for disposal as described above in Section 4.5.

4.6.4 Remediation area RA-3 (PI No. 769582)

On 3/29/17 and 3/30/17, Ambient excavated historic fill material from RA-3. The finished cavity measured between 60-70 ft long by 45 ft wide. The surrounding grade slopes, so even though the native soil at the cavity base was flat, depth below grade ranged from 5.5 – 7.0 ft bgs. As with the other residential areas, the base was advanced 1 ft deeper than the observed limit of historic fill material. Excavated soil generally consisted of sand with silt, with metal wire, brick fragments and asphalt shingles. No groundwater was encountered during remedial activities.

Thereafter, a post-excavation soil sample was collected from the cavity base. Immediately after excavation, the cavity was backfilled with clean fill and compacted. Information regarding the backfill material is included below in Section 4.9. A total of 1,551 tons of excavated soil was transported to the nearby HAL site for disposal as described above in Section 4.5.

4.7 Future restricted use area (PI No. 006594)

A Remedial Action Permit application is being submitted concurrent with this report. BRS anticipates that the caps (described below) will be inspected annually and a Remedial Action Protectiveness / Biennial Certification Form will be submitted every 2 years.

4.7.1 Open Space Area

On 2/27/17 and 2/28/17, Ambient removed surface soil to a depth of 2 ft in the public right-of-way known as Centennial Avenue Park. This area measures approximately 0.48 acres. In accordance with the approved RAW, Ambient installed a cap consisting of 1.75 ft of certified clean virgin fill material and 0.25 ft of topsoil. Information regarding the backfill/cap material is included in Section 4.9. The remediation area is depicted on **Figure 6** and a cross-section of the cap is depicted on **Figure 7**. A total of 2,077 tons of excavated soil was transported to the nearby HAL site for disposal as described above in Section 4.5.

4.7.2 Centennial Avenue

Centennial Avenue originally began at North Front Street, extended east paralleling the site, and terminating at ABC Barrel Building No. 2. A tax map taken from Appendix B of the 1996 PA report is



included in **Appendix D** and depicts the original configuration. The site buildings were subsequently demolished in 2003. Thereafter, circa 2008, Pennrose Properties extended Centennial Avenue eastward across a small portion of the site to its intersection with Second Street. This was done in order to provide access to new residences that were being constructed southeast of the site between Centennial Avenue and Penn Street. This is the configuration that exists presently.

Approximately 900 ft² (0.02 acre) of the former site was paved by this work, effectively capping the contaminated HFM that's presumed to exist there. The roadway consists of a 6-inch thick subbase of dense graded aggregate, overlain by a 4-inch thick bituminous base course and a 2-inch thick bituminous surface course. The Construction Details figure prepared by the project engineer specifying the roadway construction is included in **Appendix D**. The capped part of Centennial Avenue is depicted on **Figure 6** and a cross-section of the cap is depicted on **Figure 7**.

4.7.3 Deed Notice

Because contaminants above the residential direct contact soil remediation standards (RDCSRS) were left in place at PI No. 006594, a Deed Notice was recorded with the Camden County Clerk's Office. The Deed Notice serves as an institutional control to protect the public from potential exposure by restricting the future use of the property. A soil remedial action permit is being requested concurrent with this report. A copy of the recorded Deed Notice is included in **Appendix E**. The Deed Notice boundary was submitted in GIS format and the confirmation email is in **Appendix A**.

4.8 Concrete Sampling and Disposal

Concrete that was encountered during remedial activities was stockpiled. One stockpile consisted of visibly clean concrete pieces (stockpile "A1"), while a separate stockpile consisted of any surface slabs or pieces that evidenced possible staining (stockpile "A2"). Each stockpile was estimated to be 100 cubic yards (cy). As a result, in accordance with NJDEP's 1/12/10 *Guidance for Characterization of Concrete and Clean Material Certification for Recycling*, one 5-point composite sample was collected from each stockpile. Sampled material consisted of concrete chips from the surface and were biased to any suspected staining.

Samples were submitted to Phoenix Environmental Laboratories, Inc. (Phoenix) of Manchester, Connecticut (NJDEP-Certification No. CT-003) for Target Compound List (TCL) polychlorinated biphenyl (PCB) and PAH analyses.

The sample results from stockpile "A1" were compliant with the RDCSRS and were recycled at Riverfront Recycling and Aggregate, LLC in Camden, New Jersey. Sample results from stockpile "A2" slightly exceeded the RDCSRS for benzo(a)pyrene, so this concrete was disposed at Superior Materials, Inc., of Fairless Hills, Pennsylvania. Final volumes of concrete were 100 cy for stockpile "A1" and 80 cy for stockpile "A2".



The sample results are presented on **Table 2**. Laboratory Reduced Deliverable Reports are included in **Appendix F** and disposal and recycling documentation is in **Appendices C-3** and **C-4**, respectively.

4.9 Backfill Material and Restoration

A total of 17,920 tons of clean fill were imported to the site and used to backfill excavation areas and to construct the soil cap. The material is a virgin product that was transported directly to the site from Hanson Aggregates BMC, Inc., located on Williamstown Road in Winslow Township, Camden County, New Jersey. The facility is registered as a mine with the New Jersey Department of Labor and Workforce Development. On 2/15/17, the LSRP spoke with Mine Safety Inspector Dave Melegari, who indicated that the facility had no violations. As a result, no samples of the fill were tested. A clean fill certification from the facility and weight tickets are included in **Appendix G**.

A total of 940 cy of topsoil was imported to the site to establish vegetation. The material was transported directly to the site from Steven L. Foster, LLC in Pilesgrove Township, New Jersey. A topsoil sample was collected by the facility on 11/7/16 and analyzed by Mid-Atlantic Environmental Laboratories, Inc., of New Castle, Delaware (NJ License No. DE003). The results showed no exceedances of the RDCSRS or Default Impact to Ground Water Soil Screening Level (DIGWSSL). Facility analytical results and weight tickets are included in **Appendix G**.

On 4/2/18, BRS collected 7 grab samples of the emplaced topsoil, plus one field duplicate, from a depth of 0-0.5 ft bgs. Prior to collection, the locations were screened with a calibrated PID, which did not evidence any volatile organic vapors in the soil. Samples were collected into laboratory-supplied glassware, transferred into a cooler with ice, and submitted under chain of custody to SGS of Dayton, New Jersey (NJDEP-Certification No. 12129) for Target Analyte List (TAL) Metals, Target Compound List (TCL) Semi-volatiles, TCL Pesticides and TCL PCB analyses.

The topsoil analytical results were compliant with the RDCSRS and NRDCSRS. Aluminum and Manganese exceeded their respective DIGWSSL, however these analytes are secondary contaminants, so the IGW pathway does not need to be addressed. Topsoil sample results are presented on **Table 3** and sample locations are shown on **Figure 8**. The Electronic Data Deliverable (EDD) was submitted to NJDEP and the confirmation e-mails are included in **Attachment A**.

Following the installation of topsoil, grass seed, fertilizer and straw were applied. Thereafter, a fence was installed around the perimeter of the site to prevent unauthorized use.

5.0 POST-EXCAVATION SAMPLING AND DATA EVALUATION

All samples discussed below were analyzed by Phoenix. The associated reduced data deliverables are provided in **Appendix F**. An EDD for all samples discussed below was submitted to NJDEP and the resulting confirmation email is provided in **Appendix A**.



5.1 AOC-B2 (Former 1,000-gallon Fuel Oil UST)

On 2/28/17, immediately following soil excavation activities, the cavity base and sidewalls were evaluated for evidence of residual petroleum impacts. Visual and olfactory observations did not identify impacts, and vapor measurements using a calibrated PID remained at background.

Four (4) soil samples from the cavity sidewalls and one (1) sample from the cavity base were collected. In addition, one (1) field duplicate sample was collected. Sample locations are depicted on **Figure 4**. Sample collection depths were 7.5-8.0 ft bgs for sidewall samples and 8.0-8.5 ft bgs for the base sample. Samples were collected into laboratory-supplied glassware, transferred into a cooler with ice, and submitted under chain of custody to Phoenix for Extractable Petroleum Hydrocarbons (EPH) with contingent naphthalene and 2- methyl naphthalene analyses.

The soil analytical results were compliant with the NJ residential and non-residential EPH screening criteria (5,100 and 54,000 mg/kg, respectively). All results, including the field duplicate, were non-detect, therefore contingent analyses were not requested. Post-excavation soil sample results for AOC-B2 are presented on **Table 4**.

5.2 AOC-G (Former Drain/Trench/Piping Area)

On 3/1/17, immediately following soil excavation activities, the cavity base and sidewalls were evaluated for evidence of residual solvent impacts. Visual and olfactory observations did not identify impacts, and vapor measurements using a calibrated PID remained at background.

Four (4) soil samples from the cavity sidewalls and one (1) sample from the cavity base were collected. In addition, one (1) field duplicate sample and one (1) trip blank sample were collected. Sample locations are depicted on **Figure 5**. Sample collection depths were 5.5-6.0 ft bgs for sidewall samples and 6.0-6.5 ft bgs for the base sample. Samples were collected into laboratory-supplied EnCore Samplers, transferred into a cooler with ice, and submitted under chain of custody to Phoenix for PCE, trichloroethene (TCE), cis-1,2-dichloroethene (DCE) and vinyl chloride analyses.

The soil analytical results were compliant with the RDCSRS and NRDCSRS. Due to matrix interference, the laboratory's method detection limit slightly exceeded the DIGWSSL for PCE and vinyl chloride. Compounds for both AOCG-B and AOCG-B-DUP were not-detected. Data usability is discussed in Section 5.4, below. Post-excavation soil sample results for AOC-G are presented on **Table 5**.

5.3 Future Residential Parcels

On 3/15/17, 3/28/17 and 3/29/17 cavity base samples were collected from RA-2, RA-1 and RA-3, respectively. One (1) base sample was collected from each area as described in Section 4.6.1 above. In addition, one (1) field duplicate sample was collected from RA-2B. Sample locations are depicted on **Figure 6**. Sample collection depths were 12.0-12.5 ft bgs in RA-1 and RA-2; collection depth in RA-3 was 6.0-6.5 ft bgs. Samples were collected into laboratory-supplied glassware, transferred into a cooler with



ice, and submitted under chain of custody to Phoenix for TAL metals and TCL Polycyclic Aromatic Hydrocarbons (PAH) analyses.

Data from RA-2B and RA-2B-DUP indicate good analytical precision. The soil analytical results were compliant with the RDCSRS and NRDCSRS for all compounds. The DIGWSSL were exceeded for aluminum, beryllium, and manganese and the benzo(a)pyrene reporting limit exceeded the DIGWSSL. None of these compounds are related to former site operations but rather are from historic fill material. Therefore the impact to groundwater (IGW) pathway will be addressed with a Classification Exemption Area (CEA), as further described in Section 6, below. In addition, aluminum and manganese are secondary contaminants, so the IGW pathway does not need to be addressed for those compounds. As a result, no further investigation or remediation is required. Post-excavation soil sample results for these areas are presented on **Table 6**.

5.4 Sample Handling and Data Reliability

All samples were collected directly into laboratory-supplied glassware, placed into a cooler with ice, and transported to the analytical laboratory by courier. Chain-of-custody was maintained throughout each sampling event. Samples were analyzed by Phoenix Environmental Laboratories, Inc. (Phoenix) of Manchester, Connecticut, NJDEP certified laboratory No. CT-003 within the required holding times. The laboratory reduced deliverable reports are provided electronically in **Appendix F**. Electronic Data Deliverables (EDDs) were submitted to NJDEP electronically and the confirmation e-mail is included in **Attachment A**.

A data quality assessment was conducted by DeMaximis Data Management Solutions, Inc., of Clinton, New Jersey (DDMS), and is included in **Appendix H**. (Please note that the standards referenced in DDMS' report were in effect in May 2017. Standards shown on **Tables 4 - 6** of this report are current (2018) standards.) In its review, DDMS identified low recoveries in surrogates, matrix spike, and laboratory control samples, indicating that sample results may be biased low. In addition, the laboratory results used Reporting Limits (RLs) for benzo(a)pyrene and dibenz(a,h)anthracene that were below the lowest standards in the Initial Calibration (IC) for those compounds. As a result, DDMS raised the RLs to the lowest concentration supported by the IC. The data are reliable because the RLs are still below the respective standards, in most cases by orders of magnitude.

6.0 SITE WIDE GROUNDWATER (AOC-U)

In 1998 and 1999, as described in the 2010 RI/RAR, three groundwater monitoring wells (MW-1 through MW-3) were installed in the vicinity of AOC-B3, C1-C5, E, G, M, O and T. Samples in 1998 and 1999 exceeded criteria for VOCs, however low-flow samples in August and September 2001 were compliant.

In September 2007, a temporary well (GW-1) was installed in the vicinity of AOC-B1 and B2. A sample was collected and analyzed for VO and BN compounds. The results evidenced PAH and VO and BN tentatively identified compounds exceeding the GWQC.



In October 2008, a permitted well identified as MW-4 was installed in the same location as GW-1. In October and December of 2008, samples were collected from MW-4 via low-flow techniques and analyzed for TCL VO and TCL SVOC compounds. The results were compliant with the GWQC. In addition, MW-1 through MW-3 were inspected and did not evidence sheen or PID measurements.

A groundwater RIR was submitted in 2009 and an unrestricted NFA for groundwater was issued in 2010, a copy of which is included in **Appendix A**. The 1998/1999 groundwater data is unavailable for order of magnitude review, and the analyses are likely insufficient to compare to current standards. Therefore, to ensure that the NFA remains protective into the future, the property owner is implementing a Classification Exemption Area (CEA). This action is being taken to ensure that groundwater will not be used for drinking should it become impacted by HFM in the Centennial Avenue Park area (capped area). The CEA boundary was submitted in GIS format and the confirmation email is in **Appendix A**.

7.0 RECEPTOR EVALUATION

The July 2010 RIR/RAR documents an ecological evaluation, sensitive receptor search, and well search, which concluded with a recommendation of no further investigation. However, in accordance with NJAC 7:26E-1.12, the following section presents the results of a Receptor Evaluation (RE) update.

7.1 Land Use

A total of 91 parcels are located within 200 ft of the site boundary. Of those, there are 79 residential, 5 vacant, 3 open space, 2 office, 1 restaurant, and 1 religious institution. There are no child care centers, schools (grades K-12), or other sensitive populations within 200 ft of the site. See **Table 7** and **Figure 9**. The only parcels with a proposed change in land use are those that were part of the site and are the subject of this report.

7.2 Groundwater

As discussed in Section 6, a groundwater CEA is being implemented to ensure that receptors will not be affected should groundwater become impacted by HFM. As a result, a well search was performed for the purposes of this RE. A one-mile radius well search was conducted in August 2017 using the NJDEP Dataminer's "XY Well Search" query, which returned a total of 39 wells (*raw potable results*). In a Geographic Information System (GIS), a parabolic search area was created, measuring 250 ft upgradient, 500 ft sidegradient and 1,000 ft downgradient of the site boundary. None of the *raw potable results* were located within atlas grids that intersected the search area, therefore a door-to-door canvass for unpermitted wells is not required.

In addition, the Site is not located within a Well Head Protection Area or a Water Source Area. In addition, the area surrounding the site is serviced by the Camden City Water Department (Purveyor NJ0408001). Atlas grids, the search area and *raw potable results* are shown in **Figure 10**. No further action related to this groundwater receptor evaluation is required.



7.3 Vapor Intrusion

Any potential groundwater impacts at the site are PAH compounds or metals resulting from HFM. These compounds do not have Vapor Intrusion Screening Levels and do not present a vapor intrusion concern. No free product was identified at the site. No conditions indicative of a completed vapor intrusion pathway have been reported in any surrounding dwellings. As a result, further evaluation of the vapor intrusion pathway is not required.

7.4 Ecological

An ecological receptor evaluation involves identifying: (1) Environmentally Sensitive Natural Resources (ESNRs); (2) Contaminants of Potential Ecological Concern (COPECs); and (3) a migration pathway.

According to NJ-GeoWeb, the NJDEP classifies the Land Use (2012) in the vicinity of the site as *Urban Land*. The closest surface water body is the Delaware River, located approximately 1,500 ft to the west. No mapped or observed wetlands were identified on or near the site. An inspection of the NJDEP Landscape Project maps indicates that the site falls within the Piedmont Plains landscape region. Neither species-based habitat patches nor vernal habitat are found on or near the site.

Given that no ESNRs have been identified at or surrounding the site, no further investigation of ecological receptors is required.



8.0 CONCLUSION

As part of remedial action activities for the site, three AOCs, including site-wide historic fill material, were addressed. The following conclusions have been made:

- Prior reporting for this site established that all AOCs (except AOC-B2, G and T, described below) were compliant with NJDEP standards. The LSRP concurs with this assessment.
- Soil was excavated from AOC-B2. Post-excavation samples were compliant with RDCSRS.
- Soil was excavated from AOC-G. Post-excavation samples were compliant with RDCSRS.
- AOC-T (Historic Fill Material) was fully excavated from future residential parcels (SRP PI Nos. 769654, 769582 and 769626). Post-excavation base samples were compliant with RDCSRS. The site is suitable for unrestricted use.
- AOC-T (Historic Fill Material) was excavated from the top two feet at the future Centennial Avenue Park property (SRP PI No. 006594). Remaining historic fill material was capped and a Deed Notice was recorded to restrict future use of the property. In addition, a Soil Remedial Action Permit is being requested. Once issued, AOC-T remediation will be complete.
- Classification Exemption Areas are being implemented for the future Centennial Avenue Park property and each of the future residential areas.

As such, upon approval of the Soil Remedial Action Permit, the LSRP of record will issue the following Response Action Outcomes (RAOs):

- PI No. 006594 – Restricted RAO-A for soil and limited-restricted RAO-E for groundwater
- PI No. 769654 – Unrestricted RAO-A for soil and limited-restricted RAO-E for groundwater
- PI No. 769582 – Unrestricted RAO-A for soil and limited-restricted RAO-E for groundwater
- PI No. 769626 – Unrestricted RAO-A for soil and limited-restricted RAO-E for groundwater



TABLES



Table 1
Soil Sampling Summary
ABC Barrel Company Site
308 to 322 N. Front Street, Camden, NJ
NJDEP SRP Program Interest Nos. 006594, 769654, 769582, 769626

PI No.	Sample ID	Lab ID	Location	Depth	Analyses
769626	RA-1B	BX96078	RA-1 base	12-12.5	Metals, PAHs
	TS-5	JC63361-6	Topsoil	0-0.5	Metals, SVOA, PCB, Pesticide
	TS-6	JC63361-7	Topsoil	0-0.5	Metals, SVOA, PCB, Pesticide
769654	RA-2B	BX87625	RA-2 base	12-12.5	Metals, PAHs
	RA-2B DUP	BX87626	duplicate	12-12.5	Metals, PAHs
	TS-1	JC63361-1	Topsoil	0-0.5	Metals, SVOA, PCB, Pesticide
	TS-2	JC63361-2	Topsoil	0-0.5	Metals, SVOA, PCB, Pesticide
769582	RA-3B	BX96643	RA-3 base	6-6.5	Metals, PAHs
	TS-7	JC63361-8	Topsoil	0-0.5	Metals, SVOA, PCB, Pesticide
006594	AOCB2-S1	BX79142	AOC-B2 sidewall	7.5-8	EPH
	AOCB2-S2	BX79143	AOC-B2 sidewall	7.5-8	EPH
	AOCB2-S3	BX79144	AOC-B2 sidewall	7.5-8	EPH
	AOCB2-S4	BX79145	AOC-B2 sidewall	7.5-8	EPH
	AOCB2-S4 DUP	BX79146	duplicate	7.5-8	EPH
	AOCB2-B	BX79147	AOC-B2 base	8-8.5	EPH
	AOCG-B	BX79135	AOC-G base	6-6.5	PCE, TCE, DCE, VC
	AOCG-B DUP	BX79136	duplicate	6-6.5	PCE, TCE, DCE, VC
	AOCG-S1	BX79137	AOC-G sidewall	5.5-6	PCE, TCE, DCE, VC
	AOCG-S2	BX79138	AOC-G sidewall	5.5-6	PCE, TCE, DCE, VC
	AOCG-S3	BX79139	AOC-G sidewall	5.5-6	PCE, TCE, DCE, VC
	AOCG-S4	BX79140	AOC-G sidewall	5.5-6	PCE, TCE, DCE, VC
	TS-3	JC63361-3	Topsoil	0-0.5	Metals, SVOA, PCB, Pesticide
	TS-4	JC63361-4	Topsoil	0-0.5	Metals, SVOA, PCB, Pesticide
	TS-4DUP	JC63361-5	Topsoil	0-0.5	Metals, SVOA, PCB, Pesticide

Table 2
Concrete Debris Analytical Results
ABC Barrel Company Site
308 to 322 N. Front Street, Camden, NJ
NJDEP SRP Program Interest Nos. 006594, 769654, 769582, 769626

Sample Id	DIGWSSL	RDCSRS	CONC-A1	CONC-A2
Collection Date			3/15/17	3/7/17
PCBs, Aroclors By SW8082A (mg/Kg)				
PCB-1016	0.2	0.2	<0.071	< 0.068
PCB-1221	0.2	0.2	<0.071	< 0.068
PCB-1232	0.2	0.2	<0.071	< 0.068
PCB-1242	0.2	0.2	<0.071	< 0.068
PCB-1248	0.2	0.2	<0.071	< 0.068
PCB-1254	0.2	0.2	<0.071	< 0.068
PCB-1260	0.2	0.2	<0.071	< 0.068
PCB-1262	0.2	0.2	<0.071	< 0.068
PCB-1268	0.2	0.2	<0.071	< 0.068
PAHs By SW8270D (mg/Kg)				
2-Methylnaphthalene	8	230	< 0.360	< 0.350
Acenaphthene	110	3,400	< 0.360	< 0.350
Acenaphthylene	NS	NS	< 0.360	< 0.350
Anthracene	2,400	17,000	< 0.360	< 0.350
Benz(a)anthracene	0.8	0.6	< 0.360	0.300 J
Benzo(a)pyrene	0.2	0.2	< 0.200	0.250
Benzo(b)fluoranthene	2	0.6	< 0.360	0.250 J
Benzo(ghi)perylene	NS	380,000	< 0.360	0.130 J
Benzo(k)fluoranthene	25	6	< 0.360	0.230 J
Chrysene	80	62	< 0.360	0.320 J
Dibenz(a,h)anthracene	0.8	0.2	< 0.200	< 0.200
Fluoranthene	1,300	2,300	< 0.360	0.590
Fluorene	170	2,300	< 0.360	< 0.350
Indeno(1,2,3-cd)pyrene	7	0.6	< 0.360	0.140 J
Naphthalene	25	6	< 0.360	< 0.350
Phenanthrene	NS	NS	< 0.360	0.420
Pyrene	840	1,700	< 0.360	0.520

Notes:

mg/kg = Milligrams per kilogram

NS = No Standard

DIGWSSL = Default Impact to Groundwater Soil Screening Level

RDCSRS = Residential Direct Contact Soil Remediation Standard in effect March 2017

Non-detect compounds are shown as less than (<) the Reporting Limit

Analytical result exceeds standard

Table 3
Topsoil Analytical Results
ABC Barrel Company Site
308 to 322 N. Front Street, Camden, NJ
NJDEP SRP Program Interest Nos. 006594, 769654, 769582, 769626

Sample Id	DIGWSSL	RDCSRS	TS-1	TS-2	TS-3	TS-4
Collection Date			4/2/18	4/2/18	4/2/18	4/2/18
Sample Depth			0 - 0.5 ft	0 - 0.5 ft	0 - 0.5 ft	0 - 0.5 ft
Metals, Total (mg/Kg)						
Aluminum	6,000	78,000	7720	6650	7670	7830
Antimony	6	31	<2.6	<2.6	<2.6	<2.6
Arsenic	19	19	5.8	6	6.2	6.4
Barium	2,100	16,000	43.4	35.3	43.1	38.6
Beryllium	0.7	16	0.38	0.35	0.39	0.38
Cadmium	2	78	<0.65	<0.65	<0.66	<0.66
Calcium	-	-	6040	5400	5880	7550
Chromium	-	-	14.4	13.4	15.7	17.8
Cobalt	90	1,600	<6.5	<6.5	<6.6	<6.6
Copper	11,000	3,100	24.5	23.4	25.6	30.1
Iron	-	-	8320	7670	8350	9210
Lead	90	400	26.3	24.5	27.2	21.7
Magnesium	-	-	1260	1250	1490	1410
Manganese	65	11,000	94.6	92.2	91	115
Mercury	0.1	23	0.079	0.058	0.067	0.052
Nickel	48	1,600	5.4	<5.2	5.8	5.9
Potassium	-	-	<1300	<1300	1330	1320
Selenium	11	390	<2.6	<2.6	<2.6	<2.6
Silver	1	390	<0.65	<0.65	<0.66	<0.66
Sodium	-	-	<1300	<1300	<1300	<1300
Thallium	3	-	<1.3	<1.3	<1.3	<1.3
Vanadium	-	78	16.9	15.5	16.2	18.9
Zinc	930	23,000	55.1	51.1	55.1	57.6
Semi-volatiles By SW8270D (µg/Kg)						
2-Chlorophenol	800	310,000	ND (21)	ND (20)	ND (21)	ND (21)
4-Chloro-3-methyl phenol	-	-	ND (26)	ND (25)	ND (26)	ND (26)
2,4-Dichlorophenol	200	180,000	ND (36)	ND (35)	ND (36)	ND (36)
2,4-Dimethylphenol	1,000	1,200,000	ND (76)	ND (74)	ND (75)	ND (76)
2,4-Dinitrophenol	300	120,000	ND (160)	ND (160)	ND (160)	ND (160)
4,6-Dinitro-o-cresol	300	6,000	ND (46)	ND (44)	ND (45)	ND (45)
2-Methylphenol	NA	310,000	ND (27)	ND (26)	ND (27)	ND (27)
3&4-Methylphenol	-	-	ND (35)	ND (34)	ND (35)	ND (35)
2-Nitrophenol	-	-	ND (28)	ND (27)	ND (28)	ND (28)
4-Nitrophenol	-	-	ND (110)	ND (110)	ND (110)	ND (110)
Pentachlorophenol	300	900	ND (40)	ND (39)	ND (39)	ND (40)
Phenol	8,000	18,000,000	ND (22)	ND (22)	ND (22)	ND (22)
2,3,4,6-Tetrachlorophenol	-	-	ND (28)	ND (27)	ND (28)	ND (28)
2,4,5-Trichlorophenol	68,000	6,100,000	ND (32)	ND (31)	ND (31)	ND (32)
2,4,6-Trichlorophenol	200	19,000	ND (25)	ND (25)	ND (25)	ND (25)
Acenaphthene	110,000	3,400,000	ND (15)	ND (14)	ND (15)	ND (15)
Acenaphthylene	NA	NA	ND (22)	ND (21)	ND (21)	ND (22)
Acetophenone	3,000	2,000	ND (9.1)	ND (8.9)	ND (9.0)	ND (9.1)
Anthracene	2,400,000	17,000,000	ND (26)	ND (25)	44	ND (26)
Atrazine	200	210,000	ND (18)	ND (18)	ND (18)	ND (18)
Benzo(a)anthracene	800	5,000	34.4 J	29.5 J	35.4 J	30.9 J
Benzo(a)pyrene	200	500	33.8 J	29.1 J	27.9 J	34.4 J
Benzo(b)fluoranthene	2,000	5,000	47.1	35.3 J	38.9 J	68.7
Benzo(g,h,i)perylene	NA	380,000,000	27.9 J	ND (21)	ND (21)	27.7 J
Benzo(k)fluoranthene	25,000	45,000	ND (20)	19.5 J	ND (20)	24.9 J
4-Bromophenyl phenyl ether	-	-	ND (16)	ND (16)	ND (16)	ND (16)
Butyl benzyl phthalate	230,000	1,200,000	ND (10)	ND (10)	ND (10)	ND (10)
1,1'-Biphenyl	140,000	61,000	ND (5.8)	ND (5.7)	ND (5.8)	ND (5.8)
Benzaldehyde	NA	6,100,000	26.2 J	ND (10)	ND (10)	ND (11)
2-Chloronaphthalene	-	-	ND (10)	ND (9.8)	ND (10)	ND (10)

Table 3
Topsoil Analytical Results
ABC Barrel Company Site
308 to 322 N. Front Street, Camden, NJ
NJDEP SRP Program Interest Nos. 006594, 769654, 769582, 769626

Sample Id	DIGWSSL	RDCSRS	TS-1	TS-2	TS-3	TS-4
			4/2/18	4/2/18	4/2/18	4/2/18
			0 - 0.5 ft	0 - 0.5 ft	0 - 0.5 ft	0 - 0.5 ft
4-Chloroaniline	-	-	ND (15)	ND (15)	ND (15)	ND (15)
Carbazole	NA	24,000	ND (6.2)	ND (6.0)	ND (6.1)	ND (6.2)
Caprolactam	12,000	31,000,000	ND (17)	ND (16)	ND (17)	ND (17)
Chrysene	80,000	450,000	35.8 J	31.4 J	88.9	63.1
bis(2-Chloroethoxy)methane	-	-	ND (9.1)	ND (8.9)	ND (9.0)	ND (9.1)
bis(2-Chloroethyl)ether	200	400	ND (18)	ND (18)	ND (18)	ND (18)
2,2'-Oxybis(1-chloropropane)	5,000	23,000	ND (15)	ND (15)	ND (15)	ND (15)
4-Chlorophenyl phenyl ether	-	-	ND (14)	ND (13)	ND (14)	ND (14)
2,4-Dinitrotoluene	NA	700	ND (13)	ND (13)	ND (13)	ND (13)
2,6-Dinitrotoluene	NA	700	ND (21)	ND (21)	ND (21)	ND (21)
3,3'-Dichlorobenzidine	200	1,000	ND (35)	ND (34)	ND (35)	ND (35)
1,4-Dioxane	-	-	ND (28)	ND (27)	ND (28)	ND (28)
Dibenzo(a,h)anthracene	800	500	ND (19)	ND (18)	ND (19)	ND (19)
Dibenzofuran	-	-	ND (17)	ND (17)	ND (17)	ND (17)
Di-n-butyl phthalate	760,000	6,100,000	ND (6.9)	ND (6.7)	ND (6.9)	ND (6.9)
Di-n-octyl phthalate	3,300,000	2,400,000	ND (11)	ND (10)	ND (10)	ND (11)
Diethyl phthalate	88,000	49,000,000	ND (9.1)	ND (8.8)	ND (9.0)	ND (9.0)
Dimethyl phthalate	-	-	ND (7.6)	ND (7.4)	ND (7.5)	ND (7.6)
bis(2-Ethylhexyl)phthalate	1,200,000	35,000	ND (10)	ND (9.7)	ND (9.8)	ND (9.9)
Fluoranthene	1,300,000	2,300,000	59.2	49.2	45.5	134
Fluorene	170,000	2,300,000	ND (20)	ND (19)	ND (19)	ND (19)
Hexachlorobenzene	200	300	ND (11)	ND (10)	ND (11)	ND (11)
Hexachlorobutadiene	900	6,000	ND (17)	ND (17)	ND (17)	ND (17)
Hexachlorocyclopentadiene	320,000	45,000	ND (17)	ND (16)	ND (17)	ND (17)
Hexachloroethane	200	12,000	ND (21)	ND (20)	ND (21)	ND (21)
Indeno(1,2,3-cd)pyrene	7,000	5,000	21.6 J	19.4 J	ND (20)	24.5 J
Isophorone	200	510,000	ND (9.1)	ND (8.9)	ND (9.0)	ND (9.1)
2-Methylnaphthalene	8,000	230,000	ND (9.6)	ND (9.3)	ND (9.5)	ND (9.6)
2-Nitroaniline	NA	39,000	ND (10)	ND (9.8)	ND (9.9)	ND (10)
3-Nitroaniline	-	-	ND (11)	ND (10)	ND (11)	ND (11)
4-Nitroaniline	-	-	ND (11)	ND (11)	ND (11)	ND (11)
Naphthalene	25,000	6,000	ND (12)	ND (12)	ND (12)	ND (12)
Nitrobenzene	200	5,000	ND (16)	ND (16)	ND (16)	ND (16)
N-Nitroso-di-n-propylamine	200	200	ND (12)	ND (12)	ND (12)	ND (12)
N-Nitrosodiphenylamine	400	99,000	ND (16)	ND (15)	ND (15)	ND (16)
Phenanthrene	NA	NA	26.8 J	32.2 J	29.7 J	41.2 J
Pyrene	840,000	1,700,000	54.9	49.6	44.1	111
1,2,4,5-Tetrachlorobenzene	-	-	ND (11)	ND (11)	ND (11)	ND (11)
Semi-volatile TICs, TOTAL	-	-	3290 J	3480 J	2830 J	5340 J
Pesticides By SW8081B (µg/Kg)						
Aldrin	40	200	ND (0.67)	ND (0.68)	ND (0.69)	ND (0.71)
alpha-BHC	100	2	ND (0.66)	ND (0.67)	ND (0.69)	ND (0.70)
beta-BHC	400	2	ND (0.73)	ND (0.75)	ND (0.76)	ND (0.78)
delta-BHC	-	-	ND (0.78)	ND (0.79)	ND (0.81)	ND (0.83)
gamma-BHC (Lindane)	400	2	ND (0.60)	ND (0.61)	ND (0.62)	ND (0.63)
alpha-Chlordane	200	50	5.1	7.5	6.9	6.4
gamma-Chlordane	200	50	4.1	5.6	5.3	4.8
Dieldrin	40	3	ND (0.56)	ND (0.57)	ND (0.58)	ND (0.59)
4,4'-DDD	3000	4000	11.5	10.3	20.4	24.8
4,4'-DDE	2000	18000	4.1	2.7	6.4	7.5
4,4'-DDT	2000	11000	2.4	2.1	ND (0.75)	ND (0.76)
Endrin	23000	1000	ND (0.63)	ND (0.64)	ND (0.66)	ND (0.67)
Endosulfan sulfate	470000	2000	ND (0.63)	ND (0.65)	ND (0.66)	ND (0.67)
Endrin aldehyde	-	-	ND (0.46)	ND (0.47)	ND (0.48)	ND (0.49)
Endosulfan-I	470,000	4000	ND (0.47)	ND (0.48)	ND (0.49)	ND (0.50)

Table 3
Topsoil Analytical Results
ABC Barrel Company Site
308 to 322 N. Front Street, Camden, NJ
NJDEP SRP Program Interest Nos. 006594, 769654, 769582, 769626

Sample Id	DIGWSSL	RDCSRS	TS-1	TS-2	TS-3	TS-4
Collection Date			4/2/18	4/2/18	4/2/18	4/2/18
Sample Depth			0 - 0.5 ft	0 - 0.5 ft	0 - 0.5 ft	0 - 0.5 ft
Endosulfan-II	470000	4,000	ND (0.51)	ND (0.52)	ND (0.53)	ND (0.54)
Heptachlor	100	500	ND (0.70)	ND (0.71)	ND (0.73)	ND (0.74)
Heptachlor epoxide	70	10	ND (0.57)	ND (0.58)	ND (0.59)	ND (0.60)
Methoxychlor	390000	160000	ND (0.64)	ND (0.66)	ND (0.67)	ND (0.68)
Endrin ketone	-	-	ND (0.59)	ND (0.60)	ND (0.61)	ND (0.62)
Toxaphene	600	300	ND (19)	ND (19)	ND (20)	ND (20)
PCBs By SW8082A (µg/Kg)						
Aroclor 1016	200	200	ND (16)	ND (17)	ND (17)	ND (17)
Aroclor 1221	200	200	ND (17)	ND (17)	ND (17)	ND (18)
Aroclor 1232	200	200	ND (11)	ND (11)	ND (11)	ND (12)
Aroclor 1242	200	200	ND (6.5)	ND (6.6)	ND (6.7)	ND (6.8)
Aroclor 1248	200	200	ND (24)	ND (24)	ND (25)	ND (25)
Aroclor 1254	200	200	ND (10)	ND (10)	ND (10)	ND (11)
Aroclor 1260	200	200	ND (13)	ND (13)	ND (13)	ND (14)
Aroclor 1268	200	200	ND (6.0)	ND (6.2)	ND (6.3)	ND (6.4)
Aroclor 1262	200	200	ND (3.1)	ND (3.2)	ND (3.2)	ND (3.3)

Notes:

mg/kg = Milligrams per kilogram

µg/Kg = Micrograms per kilogram

A dash (-) signifies that no standard exists

DIGWSSL = Default Impact to Groundwater Soil Screening Level

RDCSRS = Residential Direct Contact Soil Remediation Standard

No compounds exceed the RDCSRS

Non-detect compounds are shown as less than (<) the Reporting Limit

 Analytical result exceeds DIGWSSL

Table 3
Topsoil Analytical Results
ABC Barrel Company Site
308 to 322 N. Front Street, Camden, NJ
NJDEP SRP Program Interest Nos. 006594, 769654, 769582, 769626

Sample Id	DIGWSSL	RDCSRS	TS-4DUP	TS-5	TS-6	TS-7
Collection Date			4/2/18	4/2/18	4/2/18	4/2/18
Sample Depth			0 - 0.5 ft	0 - 0.5 ft	0 - 0.5 ft	0 - 0.5 ft
Metals, Total (mg/Kg)						
Aluminum	6,000	78,000	6830	7730	7140	8010
Antimony	6	31	<2.6	<2.4	<2.5	<2.7
Arsenic	19	19	5.5	5.4	4.7	6.7
Barium	2,100	16,000	38.1	39.7	37.5	39.3
Beryllium	0.7	16	0.37	0.39	0.34	0.41
Cadmium	2	78	<0.64	<0.60	<0.63	<0.67
Calcium	-	-	5080	6970	5900	6150
Chromium	-	-	14.4	13.9	12.7	14.9
Cobalt	90	1,600	<6.4	<6.0	<6.3	<6.7
Copper	11,000	3,100	23.7	24.6	25.4	29.4
Iron	-	-	7950	7570	7410	8530
Lead	90	400	22.4	25.4	20.4	18.2
Magnesium	-	-	1270	1390	1310	1450
Manganese	65	11,000	91.3	99.2	88.5	87
Mercury	0.1	23	0.05	0.077	0.048	0.043
Nickel	48	1,600	5.1	5.4	<5.0	6
Potassium	-	-	1320	1310	<1300	1470
Selenium	11	390	<2.6	<2.4	<2.5	<2.7
Silver	1	390	<0.64	<0.60	<0.63	<0.67
Sodium	-	-	<1300	<1200	<1300	<1300
Thallium	3	-	<1.3	<1.2	<1.3	<1.3
Vanadium	-	78	15.3	15.7	15.1	16.3
Zinc	930	23,000	49.1	54.3	54.3	54.5
Semi-volatiles By SW8270D (µg/Kg)						
2-Chlorophenol	800	310,000	ND (20)	ND (20)	ND (21)	ND (21)
4-Chloro-3-methyl phenol	-	-	ND (25)	ND (25)	ND (26)	ND (26)
2,4-Dichlorophenol	200	180,000	ND (35)	ND (35)	ND (36)	ND (36)
2,4-Dimethylphenol	1,000	1,200,000	ND (74)	ND (73)	ND (75)	ND (76)
2,4-Dinitrophenol	300	120,000	ND (160)	ND (160)	ND (160)	ND (160)
4,6-Dinitro-o-cresol	300	6,000	ND (44)	ND (44)	ND (45)	ND (45)
2-Methylphenol	NA	310,000	ND (26)	ND (26)	ND (27)	ND (27)
3&4-Methylphenol	-	-	ND (34)	ND (34)	ND (35)	ND (35)
2-Nitrophenol	-	-	ND (27)	ND (27)	ND (28)	ND (28)
4-Nitrophenol	-	-	ND (110)	ND (110)	ND (110)	ND (110)
Pentachlorophenol	300	900	ND (39)	ND (39)	ND (39)	ND (40)
Phenol	8,000	18,000,000	ND (22)	ND (22)	ND (22)	ND (22)
2,3,4,6-Tetrachlorophenol	-	-	ND (27)	ND (27)	ND (28)	ND (28)
2,4,5-Trichlorophenol	68,000	6,100,000	ND (31)	ND (31)	ND (31)	ND (32)
2,4,6-Trichlorophenol	200	19,000	ND (25)	ND (25)	ND (25)	ND (25)
Acenaphthene	110,000	3,400,000	ND (14)	ND (14)	ND (15)	ND (15)
Acenaphthylene	NA	NA	ND (21)	ND (21)	ND (21)	ND (22)
Acetophenone	3,000	2,000	ND (8.9)	ND (8.9)	ND (9.0)	ND (9.1)
Anthracene	2,400,000	17,000,000	ND (25)	ND (25)	ND (26)	ND (26)
Atrazine	200	210,000	ND (18)	ND (18)	ND (18)	ND (18)
Benzo(a)anthracene	800	5,000	31.4 J	44.3	30.7 J	ND (12)
Benzo(a)pyrene	200	500	28.4 J	44.8	29.0 J	ND (19)
Benzo(b)fluoranthene	2,000	5,000	43	65.8	39.1 J	20.9 J
Benzo(g,h,i)perylene	NA	380,000,000	23.1 J	34.7 J	21.2 J	ND (21)
Benzo(k)fluoranthene	25,000	45,000	ND (19)	ND (19)	ND (20)	ND (20)
4-Bromophenyl phenyl ether	-	-	ND (16)	ND (16)	ND (16)	ND (16)
Butyl benzyl phthalate	230,000	1,200,000	ND (10)	ND (10)	ND (10)	ND (10)
1,1'-Biphenyl	140,000	61,000	ND (5.7)	ND (5.7)	ND (5.8)	ND (5.8)
Benzaldehyde	NA	6,100,000	ND (10)	ND (10)	ND (10)	ND (11)
2-Chloronaphthalene	-	-	ND (9.8)	ND (9.8)	ND (10)	ND (10)

Table 3
Topsoil Analytical Results
ABC Barrel Company Site
308 to 322 N. Front Street, Camden, NJ
NJDEP SRP Program Interest Nos. 006594, 769654, 769582, 769626

Sample Id	DIGWSSL	RDCSRS	TS-4DUP	TS-5	TS-6	TS-7
Collection Date			4/2/18	4/2/18	4/2/18	4/2/18
Sample Depth			0 - 0.5 ft	0 - 0.5 ft	0 - 0.5 ft	0 - 0.5 ft
4-Chloroaniline	-	-	ND (15)	ND (15)	ND (15)	ND (15)
Carbazole	NA	24,000	ND (6.0)	ND (6.0)	ND (6.1)	ND (6.2)
Caprolactam	12,000	31,000,000	ND (16)	ND (16)	ND (17)	ND (17)
Chrysene	80,000	450,000	36.8 J	49.7	29.9 J	21.6 J
bis(2-Chloroethoxy)methane	-	-	ND (8.8)	ND (8.8)	ND (9.0)	ND (9.1)
bis(2-Chloroethyl)ether	200	400	ND (18)	ND (18)	ND (18)	ND (18)
2,2'-Oxybis(1-chloropropane)	5,000	23,000	ND (15)	ND (15)	ND (15)	ND (15)
4-Chlorophenyl phenyl ether	-	-	ND (13)	ND (13)	ND (14)	ND (14)
2,4-Dinitrotoluene	NA	700	ND (13)	ND (13)	ND (13)	ND (13)
2,6-Dinitrotoluene	NA	700	ND (21)	ND (21)	ND (21)	ND (21)
3,3'-Dichlorobenzidine	200	1,000	ND (34)	ND (34)	ND (35)	ND (35)
1,4-Dioxane	-	-	ND (27)	ND (27)	ND (28)	ND (28)
Dibenzo(a,h)anthracene	800	500	ND (18)	ND (18)	ND (19)	ND (19)
Dibenzofuran	-	-	ND (17)	ND (17)	ND (17)	ND (17)
Di-n-butyl phthalate	760,000	6,100,000	ND (6.7)	ND (6.7)	ND (6.9)	ND (6.9)
Di-n-octyl phthalate	3,300,000	2,400,000	ND (10)	ND (10)	ND (10)	ND (11)
Diethyl phthalate	88,000	49,000,000	ND (8.8)	ND (8.8)	ND (9.0)	ND (9.0)
Dimethyl phthalate	-	-	ND (7.4)	ND (7.3)	ND (7.5)	ND (7.6)
bis(2-Ethylhexyl)phthalate	1,200,000	35,000	ND (9.7)	ND (9.7)	ND (9.8)	ND (9.9)
Fluoranthene	1,300,000	2,300,000	58.8	74.7	48.1	21.8 J
Fluorene	170,000	2,300,000	ND (19)	ND (19)	ND (19)	ND (19)
Hexachlorobenzene	200	300	ND (10)	ND (10)	ND (11)	ND (11)
Hexachlorobutadiene	900	6,000	ND (17)	ND (17)	ND (17)	ND (17)
Hexachlorocyclopentadiene	320,000	45,000	ND (16)	ND (16)	ND (17)	ND (17)
Hexachloroethane	200	12,000	ND (20)	ND (20)	ND (21)	ND (21)
Indeno(1,2,3-cd)pyrene	7,000	5,000	ND (19)	31.4 J	ND (20)	ND (20)
Isophorone	200	510,000	ND (8.8)	ND (8.8)	ND (9.0)	ND (9.1)
2-Methylnaphthalene	8,000	230,000	ND (9.3)	ND (9.3)	ND (9.5)	ND (9.6)
2-Nitroaniline	NA	39,000	ND (9.8)	ND (9.7)	ND (9.9)	ND (10)
3-Nitroaniline	-	-	ND (10)	ND (10)	ND (11)	ND (11)
4-Nitroaniline	-	-	ND (11)	ND (11)	ND (11)	ND (11)
Naphthalene	25,000	6,000	ND (12)	ND (12)	ND (12)	ND (12)
Nitrobenzene	200	5,000	ND (16)	ND (16)	ND (16)	ND (16)
N-Nitroso-di-n-propylamine	200	200	ND (12)	ND (12)	ND (12)	ND (12)
N-Nitrosodiphenylamine	400	99,000	ND (15)	ND (15)	ND (15)	ND (16)
Phenanthrene	NA	NA	33.6 J	34.9 J	29.2 J	ND (14)
Pyrene	840,000	1,700,000	54.3	67.6	48.6	24.9 J
1,2,4,5-Tetrachlorobenzene	-	-	ND (11)	ND (10)	ND (11)	ND (11)
Semi-volatile TICs, TOTAL	-	-	3830 J	3180 J	2940 J	3390 J
Pesticides By SW8081B (µg/Kg)						
Aldrin	40	200	ND (0.67)	ND (0.70)	ND (0.69)	ND (0.68)
alpha-BHC	100	2	ND (0.66)	ND (0.69)	ND (0.68)	ND (0.67)
beta-BHC	400	2	ND (0.74)	ND (0.76)	ND (0.75)	ND (0.75)
delta-BHC	-	-	ND (0.78)	ND (0.81)	ND (0.80)	ND (0.79)
gamma-BHC (Lindane)	400	2	ND (0.60)	ND (0.62)	ND (0.61)	ND (0.61)
alpha-Chlordane	200	50	5.5	14.6	6	2.5
gamma-Chlordane	200	50	4.5	13.6	4.7	2
Dieldrin	40	3	ND (0.56)	ND (0.58)	ND (0.57)	ND (0.57)
4,4'-DDD	3000	4000	28.6	19.2	20.3	16.9
4,4'-DDE	2000	18000	6.6	5.2	7.1	4.9
4,4'-DDT	2000	11000	4.3	3.7	4.4	3.6
Endrin	23000	1000	ND (0.63)	ND (0.66)	ND (0.65)	ND (0.64)
Endosulfan sulfate	470000	2000	ND (0.64)	ND (0.66)	ND (0.65)	ND (0.65)
Endrin aldehyde	-	-	ND (0.46)	ND (0.48)	ND (0.47)	ND (0.47)
Endosulfan-I	470,000	4000	ND (0.47)	ND (0.49)	ND (0.48)	ND (0.48)

Table 3
Topsoil Analytical Results
ABC Barrel Company Site
308 to 322 N. Front Street, Camden, NJ
NJDEP SRP Program Interest Nos. 006594, 769654, 769582, 769626

Sample Id	DIGWSSL	RDCSRS	TS-4DUP	TS-5	TS-6	TS-7
Collection Date			4/2/18	4/2/18	4/2/18	4/2/18
Sample Depth			0 - 0.5 ft	0 - 0.5 ft	0 - 0.5 ft	0 - 0.5 ft
Endosulfan-II	470000	4,000	ND (0.51)	ND (0.53)	ND (0.52)	ND (0.52)
Heptachlor	100	500	ND (0.70)	ND (0.73)	ND (0.72)	ND (0.71)
Heptachlor epoxide	70	10	ND (0.57)	1.7	ND (0.58)	ND (0.58)
Methoxychlor	390000	160000	ND (0.65)	ND (0.67)	ND (0.66)	ND (0.66)
Endrin ketone	-	-	ND (0.59)	ND (0.61)	ND (0.60)	ND (0.60)
Toxaphene	600	300	ND (19)	ND (20)	ND (19)	ND (19)
PCBs By SW8082A (µg/Kg)						
Aroclor 1016	200	200	ND (16)	ND (17)	ND (17)	ND (17)
Aroclor 1221	200	200	ND (17)	ND (17)	ND (17)	ND (17)
Aroclor 1232	200	200	ND (11)	ND (11)	ND (11)	ND (11)
Aroclor 1242	200	200	ND (6.5)	ND (6.6)	ND (6.6)	ND (6.6)
Aroclor 1248	200	200	ND (24)	ND (24)	ND (24)	ND (24)
Aroclor 1254	200	200	ND (10)	ND (10)	ND (10)	ND (10)
Aroclor 1260	200	200	ND (13)	ND (13)	ND (13)	ND (13)
Aroclor 1268	200	200	ND (6.1)	ND (6.2)	ND (6.2)	ND (6.2)
Aroclor 1262	200	200	ND (3.1)	ND (3.2)	ND (3.2)	ND (3.2)

Notes:

mg/kg = Milligrams per kilogram

µg/Kg = Micrograms per kilogram

A dash (-) signifies that no standard exists

DIGWSSL = Default Impact to Groundwater Soil Screening Level

RDCSRS = Residential Direct Contact Soil Remediation Standard

No compounds exceed the RDCSRS

Non-detect compounds are shown as less than (<) the Reporting
Analytical result exceeds DIG

Table 4
AOC-B2 Soil Analytical Results
ABC Barrel Company Site
308 to 322 N. Front Street, Camden, NJ
NJDEP SRP Program Interest No. 006594

Sample Id	NJDEP Residential Criteria	AOCB2-S1	AOCB2-S2	AOCB2-S3	AOCB2-S4	AOCB2-S4 DUP	AOCB2-B	
Collection Date		3/1/2017	3/1/2017	3/1/2017	3/1/2017	3/1/2017	3/1/2017	3/1/2017
Sample Depth		7.5-8.0	7.5-8.0	7.5-8.0	7.5-8.0	7.5-8.0	7.5-8.0	8.0-8.5
VNJ EPH Category 1 (Fuel #2/Diesel) (mg/Kg)								
>C28-C40	5,100	< 280	< 280	< 53	< 280	< 280	< 280	
C9-C28	5,100	< 280	< 280	< 53	< 280	< 280	< 280	
Total EPH	5,100	< 280	< 280	< 53	< 280	< 280	< 280	

Notes:
mg/kg milligrams per kilogram

Table 5
AOC-G Soil Analytical Results
ABC Barrel Company Site
308 to 322 N. Front Street, Camden, NJ
NJDEP SRP Program Interest No. 006594

Sample Id	DIGWSSL	RDCSRS	AOCG-B	AOCG-B DUP	AOCG-S1	AOCG-S2	AOCG-S3	AOCG-S4	TRIP BLANK	TRIP BLANK HIGH
Collection Date			3/1/2017	3/1/2017	3/1/2017	3/1/2017	3/1/2017	3/1/2017	2/28/2017	2/28/2017
Sample Depth			6-6.5	6-6.5	5.5-6.0	5.5-6.0	5.5-6.0	5.5-6.0		
Volatiles By SW8260C (mg/Kg)										
cis-1,2-Dichloroethene	.3	230	< .0057	< .0048	< .0058	< .0055	< .0056	< .0055	< .0050	< .250
Tetrachloroethene	.005	43	< .0057	< .0048	< .0058	< .0055	< .0056	< .0055	< .0050	< .250
Trichloroethene	.01	3	< .0057	< .0048	< .0058	< .0055	< .0056	< .0055	< .0050	< .250
Vinyl chloride	.005	1	< .0057	< .0048	< .0058	< .0055	< .0056	< .0055	< .0050	< .250

Notes:

mg/kg = Milligrams per kilogram

DIGWSSL = Default Impact to Groundwater Soil Screening Level

RDCSRS = Residential Direct Contact Soil Remediation Standard

No analytical results exceed the RDCSRS or DIGWSSL

Non-detect compounds are shown as less than (<) the Reporting Limit

Reporting Limit exceeds DIGWSSL

Table 6
Post-Excavation Results for Unrestricted Use Areas
ABC Barrel Company Site
308 to 322 N. Front Street, Camden, NJ
NJDEP SRP Program Interest Nos. 769654, 769582, 769626

Sample Id	DIGWSSL	RDCSRS	RA-1B	RA-2B	RA-2B DUP	RA-3B
Collection Date			3/28/17	3/15/17	3/15/17	3/30/17
Sample Depth			12.0-12.5	12.0-12.5	12.0-12.5	6.0-6.5
Metals, Total (mg/Kg)						
Aluminum	6,000	78,000	7,130	7,410	8,360	10,300
Antimony	6	31	< 1.8	< 1.9	< 1.7	< 1.9
Arsenic	19	19	< 0.74	2.45	2.58	8.41
Barium	2,100	16,000	14.5	26.5	28.6	24.4
Beryllium	0.7	16	0.29	0.37	0.42	0.74
Cadmium	2	78	< 0.37	< 0.39	< 0.33	< 0.37
Calcium	NS	NS	124	232	255	349
Chromium	NS	NS	14.4	21.3	25.4	24.1
Cobalt	90	1,600	9.69	4.63	6.59	6.67
Copper	11,000	3,100	37.6	28.2	32.6	7.96
Iron	NS	NS	6,340	16,200	17,800	24,300
Lead	90	400	1.5	4.4	4.8	5.1
Magnesium	NS	NS	1,190	1,110	1,530	2,490
Manganese	65	11,000	162	54.1	76.9	461
Mercury	0.1	23	< 0.03	< 0.03	< 0.03	< 0.03
Nickel	48	1,600	14.6	10.6	14.2	10.2
Potassium	NS	NS	1,050	1,160	1,260	3,060
Selenium	11	390	< 1.5	< 1.5	< 1.3	< 1.5
Silver	1	390	< 0.37	< 0.39	< 0.33	< 0.37
Sodium	NS	NS	10	22	30	28
Thallium	3	NS	< 1.5	< 1.5	< 1.3	< 1.5
Vanadium	NS	78	8.85	31.7	30.5	30.8
Zinc	930	23,000	50.1	24.4	31.2	35
PAHs By SW8270D (mg/Kg)						
2-Methylnaphthalene	8	230	< 0.380	< 0.350	< 0.360	< 0.370
Acenaphthene	110	3,400	< 0.380	< 0.350	< 0.360	< 0.370
Acenaphthylene	NS	NS	< 0.380	< 0.350	< 0.360	< 0.370
Anthracene	2,400	17,000	< 0.380	< 0.350	< 0.360	< 0.370
Benz(a)anthracene	0.8	5	< 0.380	< 0.350	< 0.360	< 0.370
Benzo(a)pyrene	0.2	0.5	< 0.230	< 0.250	< 0.250	< 0.260
Benzo(b)fluoranthene	2	5	< 0.380	< 0.350	< 0.360	< 0.370
Benzo(ghi)perylene	NS	380,000	< 0.380	< 0.350	< 0.360	< 0.370
Benzo(k)fluoranthene	25	45	< 0.380	< 0.350	< 0.360	< 0.370
Chrysene	80	450	< 0.380	< 0.350	< 0.360	< 0.370
Dibenz(a,h)anthracene	0.8	0.5	< 0.230	< 0.250	< 0.360	< 0.370
Fluoranthene	1,300	2,300	< 0.380	< 0.350	< 0.360	< 0.370
Fluorene	170	2,300	< 0.380	< 0.350	< 0.360	< 0.370
Indeno(1,2,3-cd)pyrene	7	5	< 0.380	< 0.350	< 0.360	< 0.370
Naphthalene	25	6	< 0.380	< 0.350	< 0.360	< 0.370
Phenanthrene	NS	NS	< 0.380	< 0.350	< 0.360	< 0.370
Pyrene	840	1,700	< 0.380	< 0.350	< 0.360	< 0.370

Notes:

mg/kg = Milligrams per kilogram

NS = No Standard

DIGWSSL = Default Impact to Groundwater Soil Screening Level

RDCSRS = Residential Direct Contact Soil Remediation Standard

No compounds exceed the RDCSRS

Non-detect compounds are shown as less than (<) the Reporting Limit

 Analytical result exceeds DIGWSSL

 Reporting Limit exceeds DIGWSSL

Table 7
Surrounding Land Use - 200 ft
ABC Barrel Company Site
308 to 322 N. Front Street, Camden, NJ
NJDEP SRP Program Interest Nos. 006594, 769654, 769582, 769626

Block	Lot	Address	Owner	Facility
51	38	SE PEARL & POINT STS	RUTGERS, THE STATE UNIVERSITY	Rutgers-Camden Community Park
52	108	405 NO 2ND ST	FRIEDMAN, STEVEN J	Residential
52	111	125 LINDEN ST	EVANS, RYAN M & KIMBERLY P	Residential
52	112	123 LINDEN ST	DOYLE, JOHN E & ELISA D	Residential
52	113	121 LINDEN ST	VAZQUEZ, JOSE A JR & ELVA	Residential
52	114	119 LINDEN ST	BONANNI, FABIAN	Residential
52	115	117 LINDEN ST	MATEO, LUZ	Residential
52	116	115 LINDEN ST	FOXX, CARRIE B	Residential
52	117	113 LINDEN ST	HARKLEY, ALFRED DR	Residential
52	118	111 LINDEN ST	JRIL, LLC	Residential
52	119	109 LINDEN ST	VAZQUEZ, LYDIA & BERMUDEZ, EDUARDO	Residential
52	120	107 LINDEN ST	CHHAYA, CHINTAN	Residential
52	121	105 LINDEN ST	KAPLAN, KATHY M; AKA JASSEM, KATHY	Residential
52	122	103 LINDEN ST	GONZALEZ, ANTONIO	Residential
52	123	101 LINDEN ST	GONZALEZ, ANTONIO S	Residential
57	56	402 NO 2ND ST	MASON, SHELLIE	Residential
61	1	339 NO FRONT ST	JUAN IN A MILLION HOLDINGS, LLC	Residential
61	2	338 POINT ST	SMULKTIS, JOHN B	Residential
61	3	336 POINT ST	CANUSO, JULIAN T JR	Residential
61	4	334 POINT ST	CANUSO, JULIAN T JR	Residential
61	5	332 POINT ST	PIERSON, ANDREW J	Residential
61	6	330 POINT ST	DOYLE, JOHN	Residential
61	7	328 POINT ST	KRUK, ERICA	Residential
61	8	326 POINT ST	BRENNER, JEFFREY & GREENBERG, JENNI	Residential
61	9	326 POINT ST	BRENNER, JEFFREY & GREENBERG, JENNI	Residential
61	10	322 POINT ST	CHACON, GABRIEL & DARIA	Residential
61	11	320 POINT ST	JOHNSON, BYRON	Residential
61	12	318 POINT ST	TORRES, ERNESTO & NORKA	Residential
61	13	316 POINT ST	SMALLS, PAUL W & KINYTA	Residential
61	14	314 POINT ST	COLON, NORKA	Residential
61	15	312 POINT ST	CURRY, WILLIAM F & CURRY, KENNETH A	Residential
61	16	310 POINT ST	CURRY, WILLIAM F & CURRY, KENNETH A	Residential
61	17	335 NO FRONT ST	REMME, SCOTT	Residential
61	18	333 NO FRONT ST	NURIN, TAMARA SHAWN	Residential
61	19	331 NO FRONT ST	CHANDLER, CARL & CHERYL	Residential
61	20	329 NO FRONT ST	STOKES, BIBBIE	Residential
61	21	327 NO FRONT ST	VAN BAAL, CRAIG	Residential
61	22	325 NO FRONT ST	KLUK, JACK	Residential
61	23	323 NO FRONT ST	ARNOLD, RAYMOND W & ARNOLD, DALE M	Residential

Table 7
Surrounding Land Use - 200 ft
ABC Barrel Company Site
308 to 322 N. Front Street, Camden, NJ
NJDEP SRP Program Interest Nos. 006594, 769654, 769582, 769626

Block	Lot	Address	Owner	Facility
61	24	315 NO FRONT ST	COOPER GRANT NEIGHBORHOOD ASSN	Open Space
61	31	51 PENN ST	RUTGERS, THE STATE UNIVERSITY	Public School property
62	1	100 LINDEN ST	SAUL, APRIL- TRUSTEE	Residential
62	2	102 LINDEN ST	NIEVES, ANDRES	Residential
62	3	104 LINDEN ST	COWARD, SHAMAIR	Residential
62	4	106 LINDEN ST	KIM, SO JOONG & SUN HEE	Residential
62	5	108 LINDEN ST	LARocca, ROBERT	Residential
62	6	110 LINDEN ST	CHAVEZ, ODIR	Residential
62	7	112 LINDEN ST	LEBAKKEN, DYLAN M & TAYLER M	Residential
62	8	114 LINDEN ST	VAZQUEZ, CARLOS M	Residential
62	9	116 LINDEN ST	VAZQUEZ, CARLOS M; ET AL	Residential
62	10	118 LINDEN ST	VAZQUEZ, JUAN C	Residential
62	11	120 LINDEN ST	STAR PROPERTY, LLC	Residential
62	12	122 LINDEN ST	MCCRAY, JOSEPH JR & CABA-MCCRAY, E	Residential
62	13	323 NO 2ND ST	JAMES, WILLIAM K	Residential
62	16	317 NO 2ND ST	WINKLER, LOIS D	Residential
62.02	17	137 PENN ST	CRENSHAW, ADRIENNE	Residential
62.02	18	135 PENN ST	MEYER, JON'A	Residential
62.02	19	133 PENN ST	RIVERA-PEREZ, SONIA & RIVERA, OSCAR	Residential
62.02	20	131 PENN ST	MACDONALD, JAMES	Residential
62.02	21	129 PENN ST	BITTNER, STEPHANIE	Residential
62.02	22	127 PENN ST	LATKO, JONATHAN	Residential
62.02	23	125 PENN ST	YODER, BRYON	Residential
62.02	26	119 PENN ST	HELMES, DONNA J	Residential
62.02	27	117 PENN ST	MCCARTHY, DONAL E	Residential
62.02	28	115 PENN ST	GILLESPIE, JUDYANN S	Residential
62.02	29	113 PENN ST	FILIPPONE, CHRISTOPHER S	Residential
62.02	30	111 PENN ST	SHAKIR, HANIF & AL-UQDAH, LOLA	Residential
62.02	31	109 PENN ST	MALONE, CHRISTINE A	Residential
62.02	32	107 PENN ST	CRUZ, JOCELYN	Residential
62.02	33	105 PENN ST	WILLIAMS, VICKY	Residential
62.02	34	103 PENN ST	WILSON, ROBERT M III	Residential
62.02	35	101 PENN ST	DEVENNEY, YOSHIKA	Residential
63	70	NW COOPER & FRONT ST	CAMDEN BOARD OF EDUCATION	City of Camden School District Central Office
64	48	NE COOPER & FRONT STS	RUTGERS STATE UNIVERSITY	Johnson Park/Walt Whitman Arts Center
65	1	332 NO 2ND ST	FRIEDMAN, STEVEN J	Vacant
65	2	330 NO 2ND ST	FRIEDMAN, STEVEN J	Residential
65	3	328 NO 2ND ST	FRIEDMAN, STEVEN J	Residential
65	4	326 NO 2ND ST	FRIEDMAN, STEVEN J	Vacant
65	5	324 NO 2ND ST	FRIEDMAN, STEVEN J	Vacant
65	6	319-321 FRIENDS AVE	CHANG, KELLY & YUN, JU LEE	Friends Café

Table 7
Surrounding Land Use - 200 ft
ABC Barrel Company Site
308 to 322 N. Front Street, Camden, NJ
NJDEP SRP Program Interest Nos. 006594, 769654, 769582, 769626

Block	Lot	Address	Owner	Facility
65	7	316 NO 2ND ST	IGLESIA PENTECOSTAL NUEVAS	Iglesia Nuevas De Gran Gozo
65	8	310 NO 2ND ST	LEONARD, IAN K	Residential
65	9	308 NO 2ND ST	LATKO, JONATHAN	Vacant
65	93	209 PENN ST	LATKO, JONATHAN	Residential
65	94	211 PENN ST	LATKO, JONATHAN	Residential
65	97	201 PENN ST	THOMAS, KOBINA & LYNNELLE	Residential
65	98	203 PENN ST	THOMAS, LYNNELLE	Residential
65	99	205 PENN ST	WANG, TERRY & KAN, JEFF	Residential
65	100	207 PENN ST	COCIAN, TEOFIL	Residential
65	103	320 NO 2ND ST	CAMDEN REDEVELOPMENT AGENCY	Vacant
69	1	215 NO 3RD ST	RUTGERS STATE UNIVERSITY	Rutgers Dormitory

FIGURES



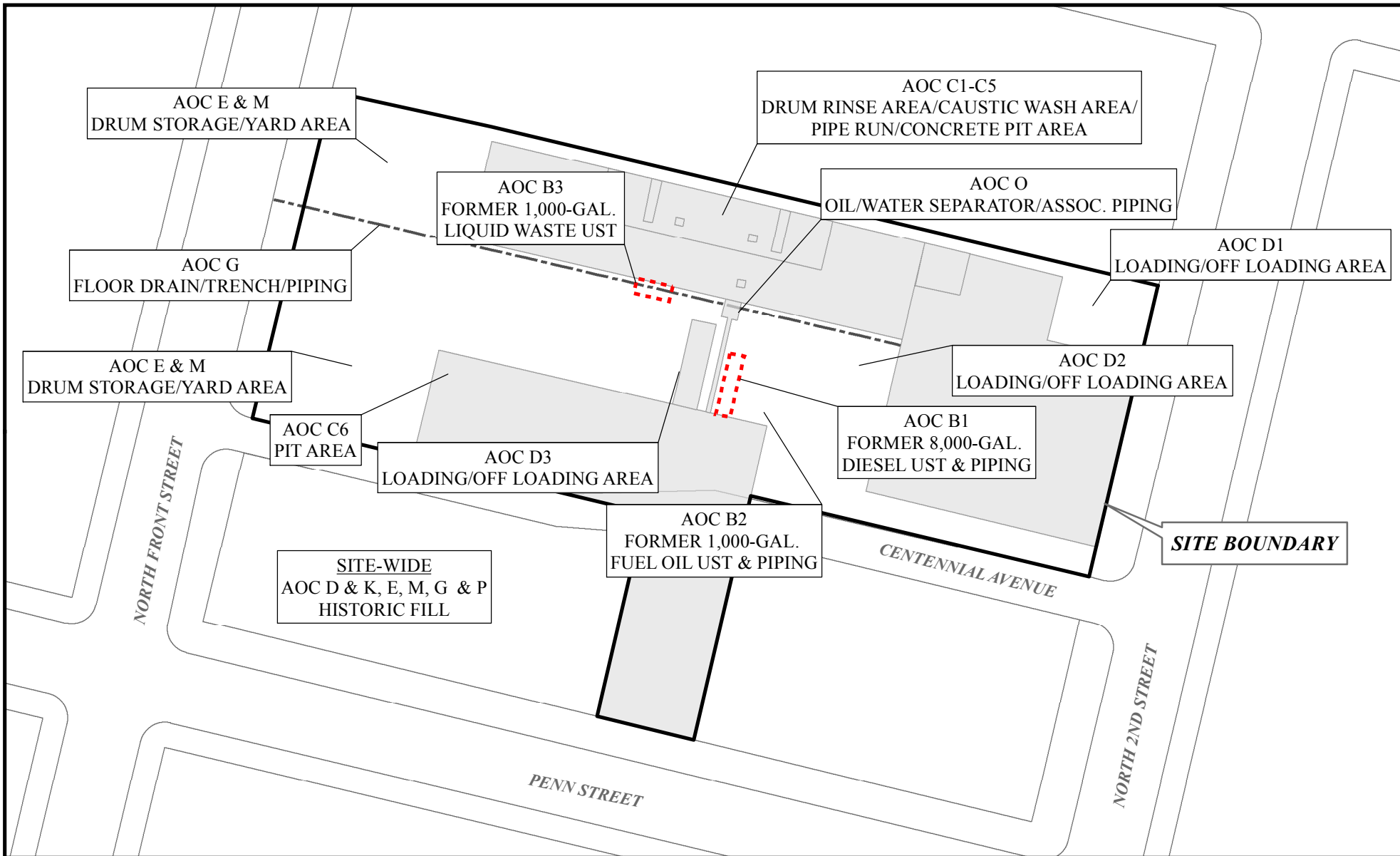

FIGURE 2: SITE OVERVIEW MAP

- Underground Storage Tank (UST), Former
- Site Boundary
- Sidewalks/Roads
- Building, Former
- Piping, Former



MAP SCALE: 1 inch = 55 feet

0 20 40 60 80 Feet

PROJECT NAME: ABC BARREL COMPANY
PROJECT ADDRESS: 308-322 NORTH FRONT STREET, CAMDEN, NJ
NJDEP SRP PI#: 006594, 769654, 769582, 769626
DATE: FEBRUARY 2018



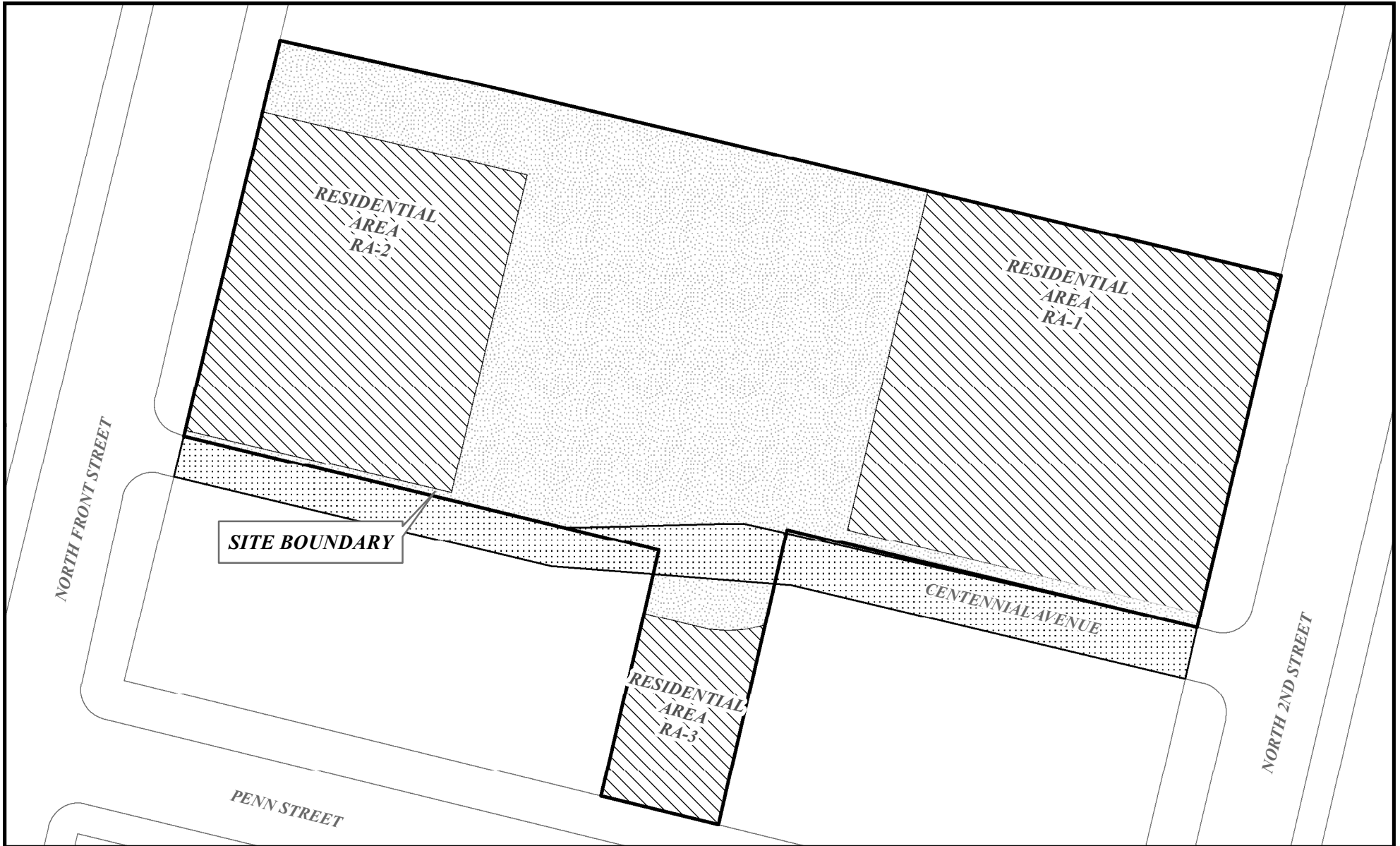

FIGURE 3: REMEDIATION AREAS

- | | | |
|--|---|---|
|  Remediated to Unrestricted Use |  Concrete |  Sidewalks/Roads |
|  Clean Fill Cap |  Site Boundary | |



MAP SCALE: 1 inch = 45 feet
 0 45 Feet

PROJECT NAME: ABC BARREL COMPANY
 PROJECT ADDRESS: 308-322 NORTH FRONT STREET, CAMDEN, NJ
 NJDEP SRP PI#: 006594, 769654, 769582, 769626
 DATE: FEBRUARY 2018



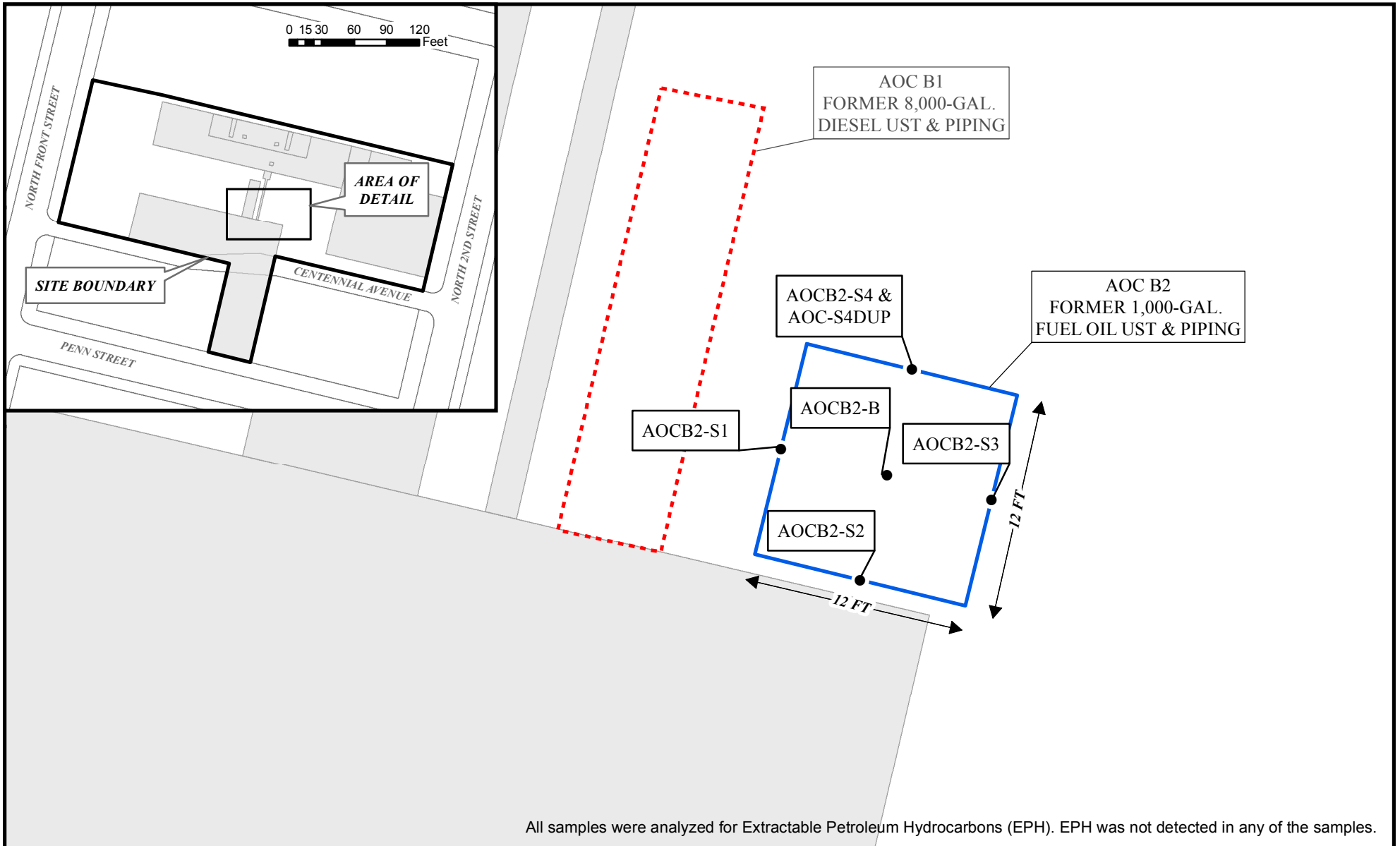

All samples were analyzed for Extractable Petroleum Hydrocarbons (EPH). EPH was not detected in any of the samples.

FIGURE 4: AOC-B2 POST-EXCAVATION SAMPLE LOCATIONS

- Soil Sample Location, AOC-B2
- ▭ Site Boundary
- ▭ Area of Excavation (AOC-B2)
- ▭ Building, Former
- ⋯ Underground Storage Tank (UST), Former
- Sidewalks/Roads



MAP SCALE: 1 inch = 7.5 feet



PROJECT NAME: ABC BARREL COMPANY
 PROJECT ADDRESS: 308-322 NORTH FRONT STREET, CAMDEN, NJ
 NJDEP SRP PI#: 006594, 769654, 769582, 769626
 DATE: FEBRUARY 2018



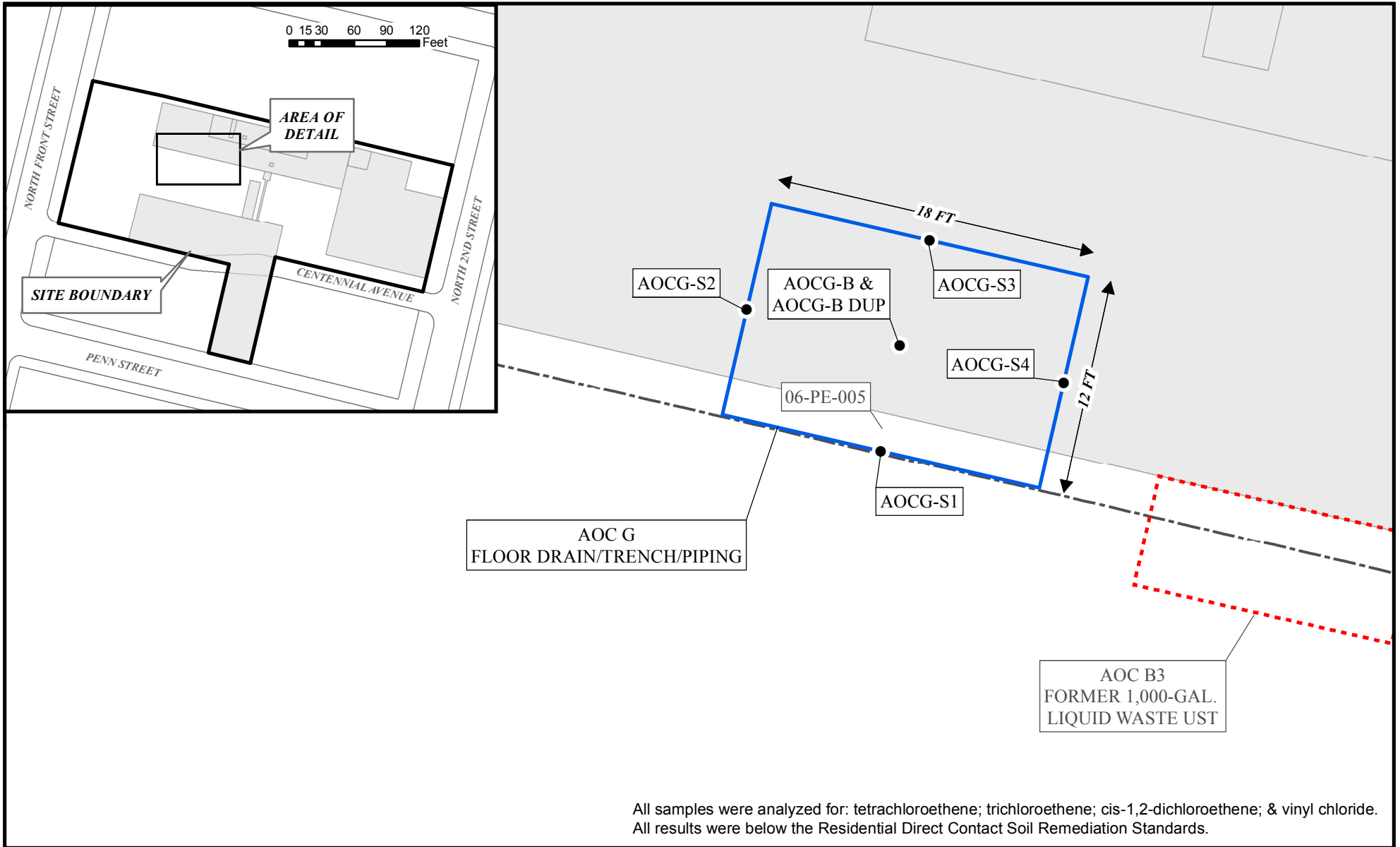

FIGURE 5: AOC-G POST EXCAVATION SAMPLE LOCATIONS

- Soil Sample Location, AOC-G
- Soil Sample Location, AOC-G - Previous
- Area of Excavation (AOC-G)
- Underground Storage Tank (UST), Former
- Building, Former
- - - Piping, Former

MAP SCALE: 1 inch = 7.5 feet

0 3 6 9 12 Feet

PROJECT NAME: ABC BARREL COMPANY
PROJECT ADDRESS: 308-322 NORTH FRONT STREET, CAMDEN, NJ
NJDEP SRP PI#: 006594, 769654, 769582, 769626
DATE: FEBRUARY 2018



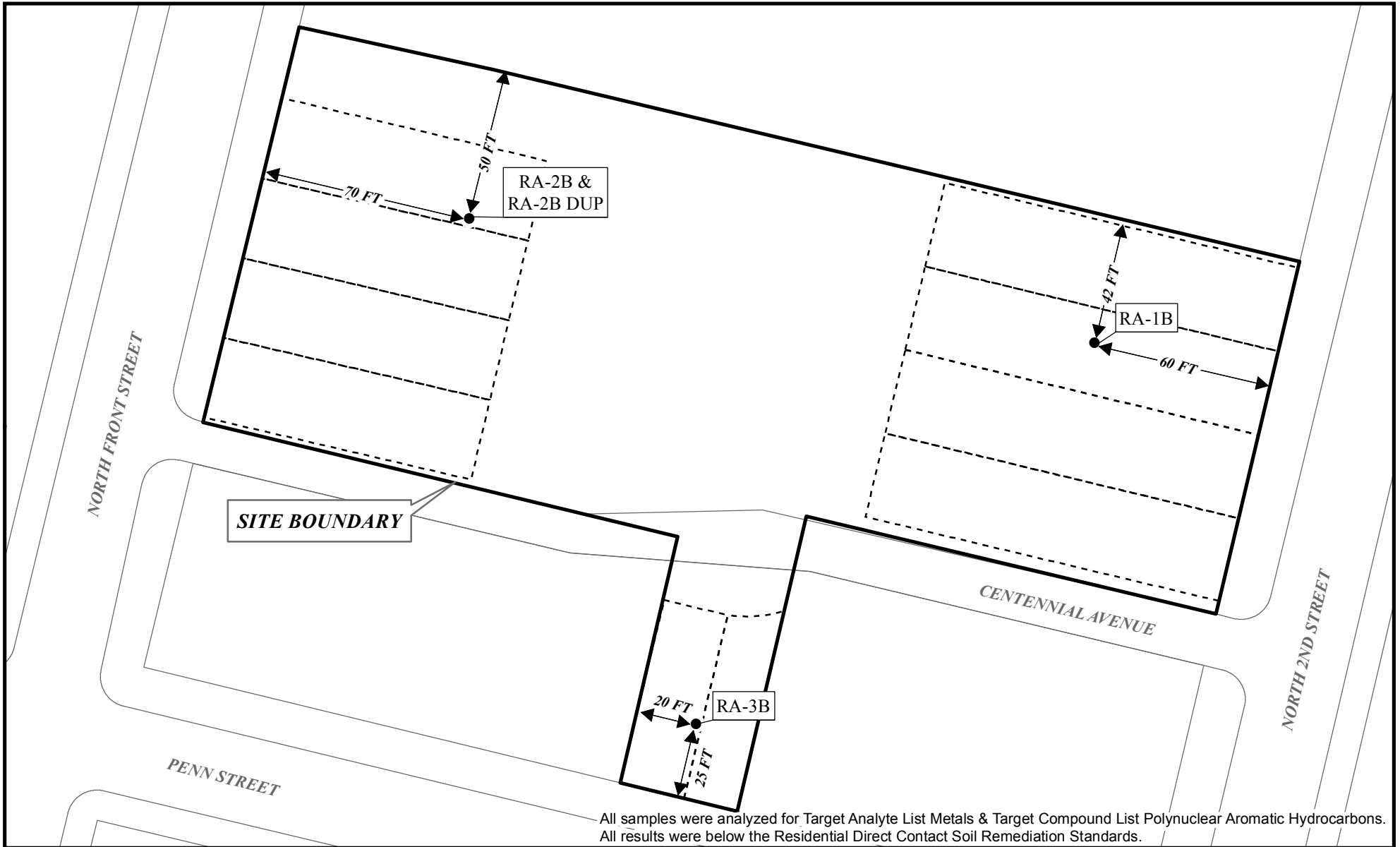

FIGURE 6: RESIDENTIAL POST-EXCAVATION SAMPLE LOCATIONS

- Soil Boring Location
- Site Boundary
- - - Lot Boundary Line
- Sidewalks/Roads

MAP SCALE: 1 inch = 45 feet

0 15 30 45 60 75 Feet

PROJECT NAME: ABC BARREL COMPANY
 PROJECT ADDRESS: 308-322 NORTH FRONT STREET, CAMDEN, NJ
 NJDEP SRP PI#: 006594, 769654, 769582, 769626
 DATE: FEBRUARY 2018



Asphalt Cap:

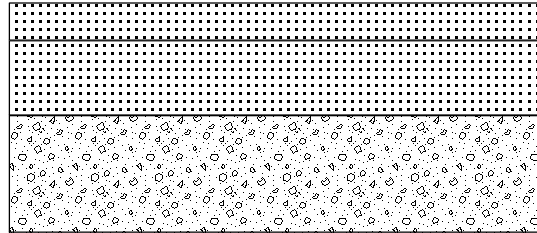

2-inch bituminous surface coat

4-inch bituminous base coat

6-inch dense graded aggregate

Soil Cap:

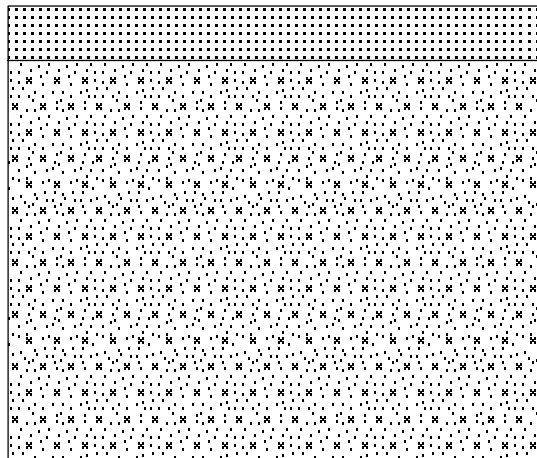

0.25 ft topsoil

1.75 ft virgin certified clean fill

FIGURE 7: CROSS SECTION OF CAPPED AREAS



NOT TO SCALE

PROJECT NAME: ABC BARREL COMPANY/CENTENNIAL AVE
PROJECT ADDRESS: 308-322 NORTH FRONT STREET, CAMDEN, NJ
NJDEP SRP PI#: 006594, 769654, 769582, 769626
DATE: FEBRUARY 2018

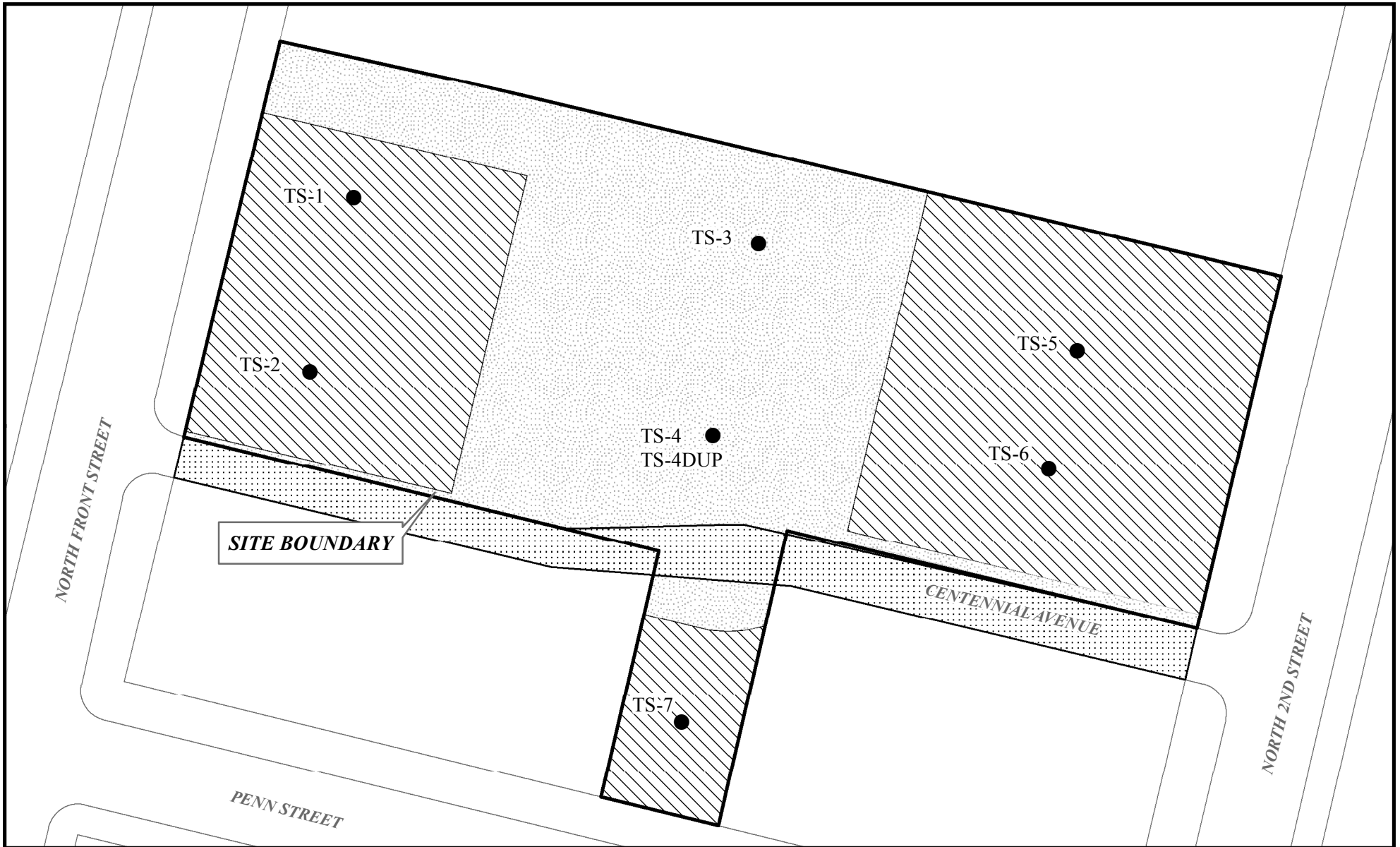

FIGURE 8: TOPSOIL SAMPLE LOCATIONS

- Topsoil Samples
- ▨ Remediated to Unrestricted Use
- ▤ Clean Fill Cap
- ▧ Concrete
- ▭ Site Boundary
- Sidewalks/Roads



MAP SCALE: 1 inch = 45 feet
 0 45 Feet

PROJECT NAME: ABC BARREL COMPANY
 PROJECT ADDRESS: 308-322 NORTH FRONT STREET, CAMDEN, NJ
 NJDEP SRP PI#: 006594, 769654, 769582, 769626
 DATE: APRIL 2018



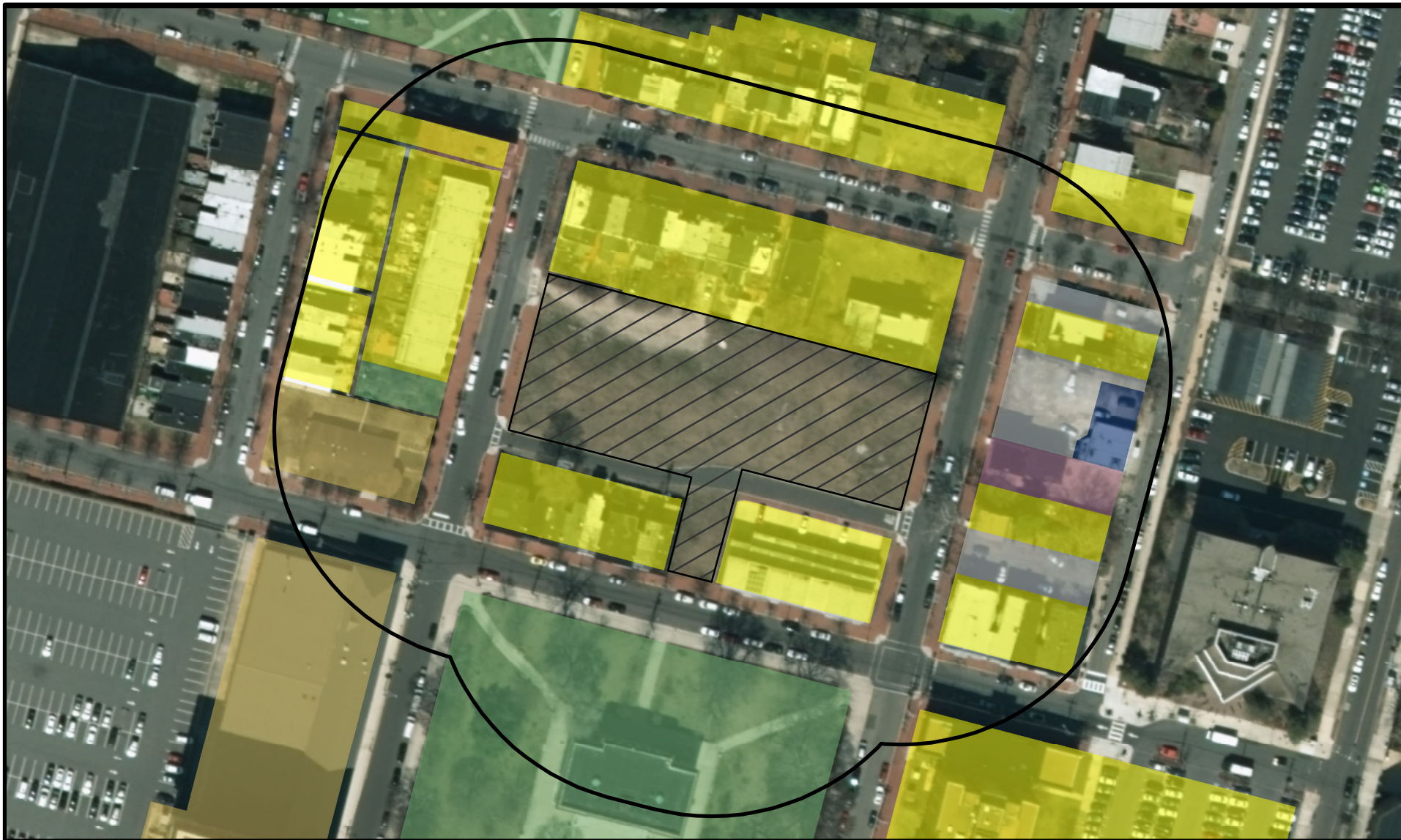
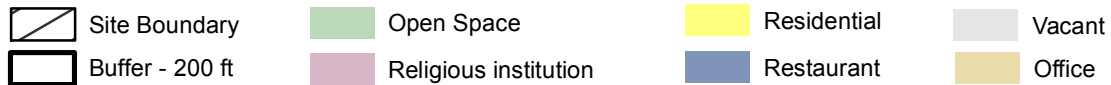
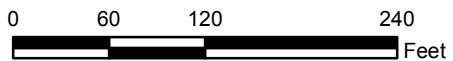

FIGURE 9: SURROUNDING LAND USE



PROJECT NAME: ABC BARREL COMPANY
PROJECT ADDRESS: 308-322 NORTH FRONT STREET, CAMDEN, NJ
NJDEP SRP PI#: 006594, 769654, 769582, 769626
DATE: FEBRUARY 2018





Source: Esri, DigitalGlobe, GeoEye, Earthstar Geographics, CNES/Airbus DS, USDA, USGS, AeroGRID, IGN, and the GIS User Community

FIGURE 10: GROUNDWATER USE

- Site Boundary
- Atlas Grids
- Focused Search Area
- Raw potable results well location



0 500 1,000 2,000
Feet

PROJECT NAME: ABC BARREL COMPANY
PROJECT ADDRESS: 308-322 NORTH FRONT STREET, CAMDEN, NJ
NJDEP SRP PI#: 006594, 769654, 769582, 769626
DATE: FEBRUARY 2018



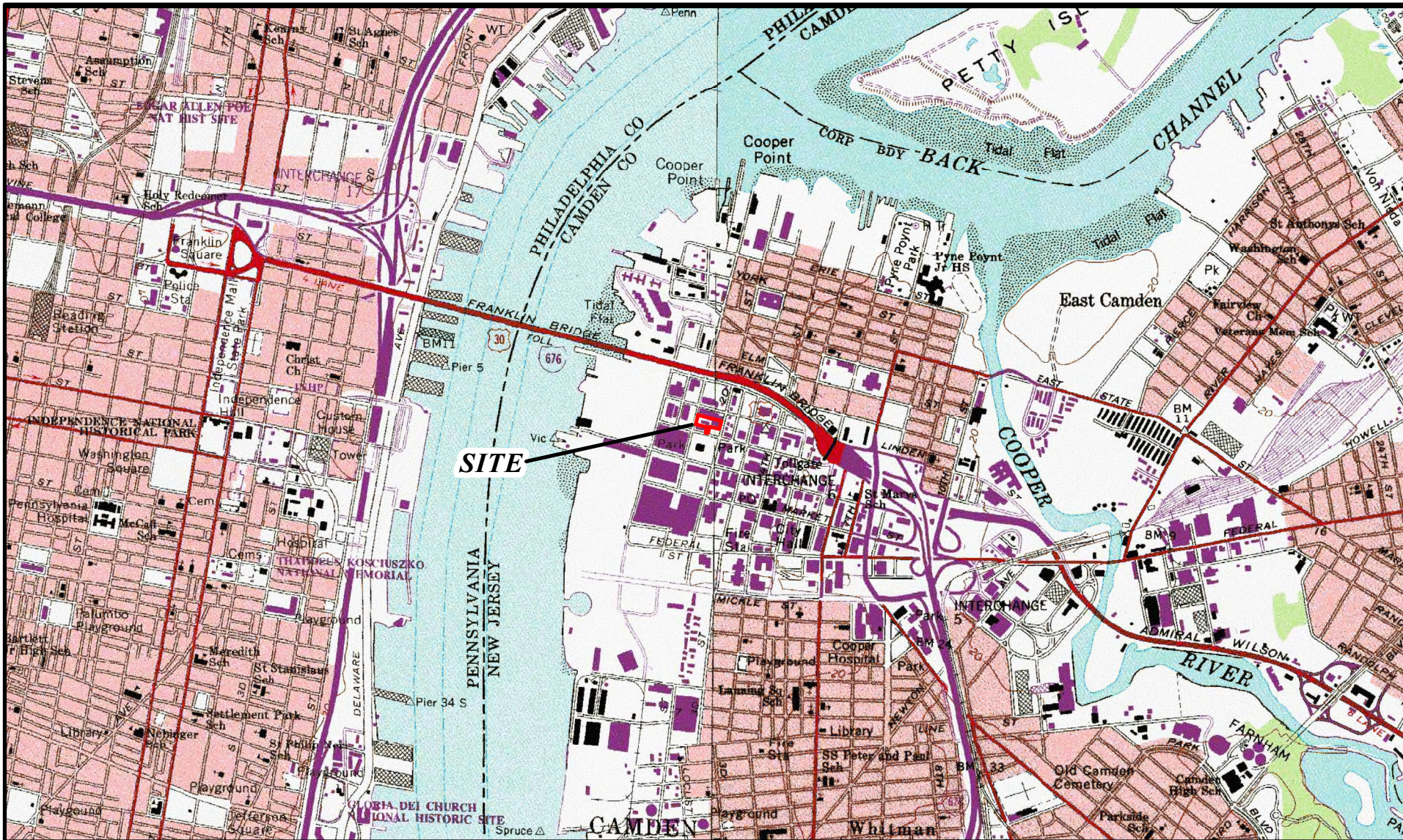

FIGURE 1: SITE OVERVIEW

 Site Boundary



0 1,000 2,000 4,000
Feet

PROJECT NAME: ABC BARREL COMPANY
PROJECT ADDRESS: 308-322 NORTH FRONT STREET, CAMDEN, NJ
NJDEP SRP PI#: 006594, 769654, 769582, 769626
DATE: FEBRUARY 2018



APPENDIX A
NJDEP CORRESPONDENCE AND APPROVALS



New Jersey Department of Environmental Protection COMMUNICATIONS CENTER NOTIFICATION REPORT

Received
Operator

Td Log#
CaseNumber #

Notification Type

Reported By Affiliation Phone
Street Address Municipality State

IncidentLocation

Site Phone
Street Municipality County State
Type Incident Date Time

Substances Released

Amount Released

ID State CAS Number

Substance Name Release Is?

Substance Contained? Hazardous Material? TCPA Chemical? A310 Letter?

COMU Code Referral Code Release Verification

Incident Description

Injuries? Public Evac? Facility Evac? Public Exposure?

Police On Scene? Firemen On Scene? DEP Requested?

Wind Speed/Direction Contamination Receiving Water

Status At Scene

Responsible Party

Party Phone

Contact Title

Street Address Municipality County State

OFFICIALS NOTIFIED

	Name	Affiliation	Phone	Date	Time
NJSP	<input type="text"/>	<input type="text"/>	<input type="text"/>	<input type="text"/>	<input type="text"/>
MUNIC	<input type="text"/>	<input type="text"/>	<input type="text"/>	<input type="text"/>	<input type="text"/>
OTHER	<input type="text"/>	<input type="text"/>	<input type="text"/>	<input type="text"/>	<input type="text"/>

	Name	Affiliation	METHOD	Date	Time	TM
1.	<input type="text"/>	DRPSR BFO-CAS	Faxed,Mailed	9/14/1995	<input type="text"/>	B
2.	<input type="text"/>	<input type="text"/>	<input type="text"/>	<input type="text"/>	<input type="text"/>	<input type="text"/>
3.	<input type="text"/>	<input type="text"/>	<input type="text"/>	<input type="text"/>	<input type="text"/>	<input type="text"/>

COMMENTS

MOA

Electronic Reproduction of Actual Incident Report

NOTICE: This information represents an alleged incident notification; and as such, can not be taken as valid or confirmed.

OCT - 4 2010

PERKS-REUTTER ASSOCIATES

*State of New Jersey*

CHRIS CHRISTIE
Governor

DEPARTMENT OF ENVIRONMENTAL PROTECTION
Bureau of Southern Field Operations
401 East State Street
P.O. Box 420
Trenton, NJ 08625-0420
Phone #: 609-633-1475
Fax #: 609-984-6004

BOB MARTIN
Commissioner

KIM GUADAGNO
Lt. Governor

September 30, 2010

Saundra Ross Johnson, Executive Director
City of Camden
Camden Redevelopment Agency
520 Market Street, Suite 1300
Camden, NJ 08101

Re: No Further Action Letter

Remedial Action Type: Unrestricted Use for Ground Water
North Front Street Associates (a.k.a. ABC Barrel Co.)
308 to 322 North Front Street
Camden City, Camden County
Program Interest #: 006594
Activity Number: BFO000001
Document Title: ABC Barrel Co 950914120653
Communications Center Number: 95-09-14-1206-53
BFO File Number: 04-08-58
Block: 62 and Lots: 38 & 44
Well Permit #s: P200801109 & P200801110

Dear Ms. Ross Johnson:

Pursuant to N.J.S.A. 58:10B-13.1 and N.J.A.C. 7:26C, the New Jersey Department of Environmental Protection (Department) issues this No Further Action Letter for the remediation of the ground water specifically referenced above, so long as the City of Camden-Camden Redevelopment Agency did not withhold any information from the Department. This action is based upon information in the Department's case file and the City of Camden-Camden Redevelopment Agency's final certified report dated March 4, 2009. In issuing this No Further Action Letter, the Department has relied upon the certified representations and information provided to the Department. To remain in compliance with the terms of this No Further Action Letter, the City of Camden-Camden Redevelopment Agency as well as each subsequent owner, lessee and operator must comply with the conditions noted below.

By issuance of this No Further Action Letter, the Department acknowledges the completion of a Preliminary Assessment, Site Investigation, Remedial Investigation and Remedial Action pursuant to the Technical Requirements for Site Remediation (N.J.A.C. 7:26E) for the ground water beneath the site and no other areas.

By operation of law a Covenant Not to Sue pursuant to N.J.S.A. 58:10B-13.1 applies to this remediation. The Covenant Not to Sue is subject to any conditions and limitations contained herein. The Covenant Not to Sue remains effective only as long as the real property referenced above continues to meet the conditions of this No Further Action Letter.

NO FURTHER ACTION CONDITIONS

Pursuant to N.J.S.A. 58:10B-12o, the City of Camden-Camden Redevelopment Agency and any other person who was liable for the cleanup and removal costs, and remains liable pursuant to the Spill Act, shall inform the Department in writing within 14 calendar days whenever its name or address changes. Any notices submitted pursuant to this paragraph shall reference the above case numbers and shall be sent to: Bureau of Case Assignment and Initial Notice – Case Assignment Section, P.O. Box 434, Trenton, N.J. 08625-0434.

The City of Camden-Camden Redevelopment Agency as well as each subsequent owner, lessee and operator (collectively Successors) shall comply with each of the following:

Well Decommissioning

Pursuant to N.J.S.A. 58:4A, the City of Camden-Camden Redevelopment Agency shall properly decommission all monitoring wells installed as part of a remediation that will no longer be used for ground water monitoring. A New Jersey licensed well driller shall decommission the wells in accordance with the requirements of N.J.A.C. 7:9D-3.1 (et seq.). After the well has been decommissioned by a New Jersey licensed well driller, the well driller is required to submit a copy of the decommissioning report on your behalf to the Bureau of Water Systems and Well Permitting. Please note that only a New Jersey licensed well driller may perform this work. More information about regulations regarding the maintenance and decommissioning of wells in New Jersey can be found at <http://www.nj.gov/dep/watersupply>. For a list of New Jersey licensed well drillers, click on the "reports" button in the left column and select "access the well permit reports." Questions can be emailed to wellpermitting@dep.state.nj.us.

NOTICES

This No Further Action Letter is for ground water only located beneath the referenced site. The Department has relied, in part, on the reported ground water data to support that soil contamination still present on the site is no longer affecting the ground water located beneath the site. Please be advised that if changes in future ground water data no longer support this conclusion, the Department reserves its rights to require additional ground water investigation and/or remediation.

Thank you for your attention to these matters. If you have any questions, please contact Cheryl Priest at (609) 292-2723.

Sincerely,

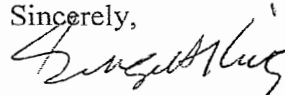

George King, Bureau Chief
Bureau of Southern Field Operations



514

State of New Jersey

DEPARTMENT OF ENVIRONMENTAL PROTECTION

Bureau of Southern Field Operations

401 East State Street

Mail Code 401-05

PO Box 420

Trenton, NJ 08625-0420

Phone # (609) 633-1475

Fax # (609) 984-6004

CHRIS CHRISTIE

Governor

KIM GUADAGNO

Lt. Governor

FEB - 1 REC'D

BOB MARTIN

Commissioner

January 24, 2012

Sandra Ross Johnson, Executive Director
Camden Development Agency - City Hall
520 Market Street, Suite 1300
PO Box 95120
Camden, NJ 08101

Approval

Re: Remedial Action Work Plan and New Jersey Pollutant Discharge Elimination System/Discharge to Ground Water Permit-By-Rule Request
North Front Street Associates (a.k.a. ABC Barrel Co. & AABCO Steel Drum Site)
308 - 322 North Front Street
Camden City, Camden County
Block 62.01; Lots 1 to 4
Block 62; Lots 17 to 20
Block 62.02; Lots 25 & 26
Block 65; Lots 38 & 45
SRP PI#: 006594
EA ID #: SUB110001
BFO File Number: 04-08-58

Dear Ms Ross Johnson:

The New Jersey Department of Environmental Protection (Department) has completed review of the Remedial Action Work Plan received on November 16, 2011. The Department has determined that the Remedial Action Work Plan is in compliance with the Technical Requirements for Site Remediation, N.J.A.C. 7:26E and other applicable requirements. The Department hereby approves the Remedial Action Work Plan, effective the date of this letter.

This New Jersey Pollutant Discharge Elimination System/Discharge to Ground Water (NJPDES/DGW) permit-by-rule discharge approval is hereby issued under the authority of the New Jersey Water Pollution Control Act, N.J.S.A. 58:10A-1 et seq. and the implementing regulations, N.J.A.C. 7:14A-1 et seq. Pursuant to N.J.A.C. 7:14A-22.4(b)5, a Treatment Works Approval is not

required for discharges to ground water authorized pursuant to N.J.A.C. 7:14A-7.5(b) and contained in this letter. Be advised that the time period for the discharge begins on the day the discharge first occurs, not on the date the discharge approval letter is issued or received.

Consistent with N.J.A.C. 7:14A-7.5(b)3 the approved discharge to ground water is related to dewatering at a contaminated site or regulated underground storage tank facility and is not to exceed 180 calendar days.

Please be aware that on May 7, 2009 the Site Remediation Reform Act (SRRA) was enacted. SRRA establishes criteria for the licensing of site remediation professionals, known as LSRP's, who will assure that contaminated sites are remediated in accordance with all prevailing statutes, regulations and guidance. The timeframes and criteria that define when a LSRP must be hired, as well as other requirements of SRRA have been reflected in the ARCS Rule and Tech Rule adopted on November 4, 2009. These rules can be found at <http://nj.gov/dep/srp/regs/>. All parties who initiated remediation prior to November 3, 2009 will not be required to hire a LSRP to conduct the remediation right away. Remediation will follow the remediation process with traditional NJDEP oversight and approvals until 2012. All parties remediating sites on or after May 7, 2012 will be required to follow N.J.S.A. 58:10B-1.3b 1-9 and hire an LSRP.

Please be advised that based upon the Department's review of your file, it is our opinion that the remediation will not be completed, reports submitted and evaluated for this site before the May 7, 2012 deadline. Therefore it will be necessary for you to complete the remediation under the LSRP program. Information regarding opting into the LSRP program can be found at http://www.nj.gov/dep/srp/srra/lrsp/opt_in.htm.

It is important to note that there are regulatory and mandatory timeframes that started March 1, 2010 that may apply to this site. Guidance for this topic can be found at http://www.nj.gov/dep/srp/srra/training/matrix/new_responsib/6_timeframe_req.pdf. Your failure to meet a mandatory timeframe will subject you to direct oversight pursuant to N.J.S.A. 58:10c-27.

Thank you for your cooperation in this matter. If you have any questions, call Cheryl Priest at (609) 292-2723.

Sincerely,

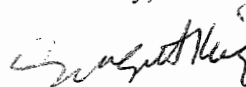

George King, Bureau Chief
Bureau of Southern Field Operations

cc: Clerk, Camden City
Camden County Health Department
Dresdner Robin
BFO File Number: 04-08-58



RECEIVED

OCT - 4 2010

State of New Jersey

PERKS-REUTTER ASSOCIATES

CHRIS CHRISTIE
Governor

DEPARTMENT OF ENVIRONMENTAL PROTECTION
Bureau of Southern Field Operations
401 East State Street
P.O. Box 420
Trenton, NJ 08625-0420
Phone #: 609-633-1475
Fax #: 609-984-6004

BOB MARTIN
Commissioner

KIM GUADAGNO
Lt. Governor

September 30, 2010

Saundra Ross Johnson, Executive Director
Camden Development Agency
City Hall, 520 Market Street
Suite 1300, P.O. Box 95120
Camden, NJ 08101

Remedial Investigation Report Approval

Re: Remedial Investigation Report (Soils Only)
ABC Barrel Company Site (a.k.a. North Front St Associates)
308 to 322 North Front Street
Camden City, Camden County
SRP PI#: 006594
EA ID #: SUB100002
BFO File Number: 04-08-58

Dear Ms. Ross Johnson:

The New Jersey Department of Environmental Protection (Department) has completed review of the Remedial Investigation Report received on July 13, 2010. The Department has determined that the Remedial Investigation Report is in compliance with the Technical Requirements for Site Remediation, N.J.A.C. 7:26E and other applicable requirements. The Department hereby approves the Remedial Investigation Report and the proposal to submit a Remedial Action Workplan, effective the date of this letter.

Pursuant to the schedule applicable to the site you shall submit a Remedial Action Workplan on October 1, 2011. Please submit the document by that date, or submit a written request for an extension at least 2 weeks prior to the due date. Failure to submit the Remedial Action Workplan in accordance with the schedule may result in the initiation of enforcement action. For your convenience, the regulations concerning the Department's remediation requirements can be found at <http://www.state.nj.us/dep/srp/regs/>.

Thank you for your cooperation in this matter. If you have any questions, call Cheryl Priest at (609) 292-2723.

Sincerely,

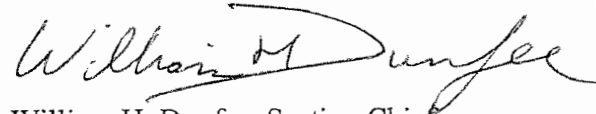
A handwritten signature in black ink that reads "William H. Dunfee". The signature is written in a cursive style with a large, sweeping initial "W".

William H. Dunfee, Section Chief
Bureau of Southern Field Operations

c: Dresdner Robin
Clerk, Camden City
Camden County Health Department
BFO File Number: 04-08-58
M. Deely, NJDEP-BC&FM



JH

State of New Jersey

DEPARTMENT OF ENVIRONMENTAL PROTECTION

Bureau of Southern Field Operations

401 East State Street

Mail Code 401-05

PO Box 420

Trenton, NJ 08625-0420

Phone # (609) 633-1475

Fax # (609) 984-6004

FEB - 1 REC'D

BOB MARTIN
Commissioner

CHRIS CHRISTIE
Governor

KIM GUADAGNO
Lt. Governor

January 24, 2012

Sandra Ross Johnson, Executive Director
Camden Development Agency - City Hall
520 Market Street, Suite 1300
PO Box 95120
Camden, NJ 08101

Approval

Re: Remedial Action Work Plan and New Jersey Pollutant Discharge Elimination System/Discharge to Ground Water Permit-By-Rule Request
North Front Street Associates (a.k.a. ABC Barrel Co. & AABCO Steel Drum Site)
308 - 322 North Front Street
Camden City, Camden County
Block 62.01; Lots 1 to 4
Block 62; Lots 17 to 20
Block 62.02; Lots 25 & 26
Block 65; Lots 38 & 45
SRP PI#: 006594
EA ID #: SUB110001
BFO File Number: 04-08-58

Dear Ms Ross Johnson:

The New Jersey Department of Environmental Protection (Department) has completed review of the Remedial Action Work Plan received on November 16, 2011. The Department has determined that the Remedial Action Work Plan is in compliance with the Technical Requirements for Site Remediation, N.J.A.C. 7:26E and other applicable requirements. The Department hereby approves the Remedial Action Work Plan, effective the date of this letter.

This New Jersey Pollutant Discharge Elimination System/Discharge to Ground Water (NJPDES/DGW) permit-by-rule discharge approval is hereby issued under the authority of the New Jersey Water Pollution Control Act, N.J.S.A. 58:10A-1 et seq. and the implementing regulations, N.J.A.C. 7:14A-1 et seq. Pursuant to N.J.A.C. 7:14A-22.4(b)5, a Treatment Works Approval is not

required for discharges to ground water authorized pursuant to N.J.A.C. 7:14A-7.5(b) and contained in this letter. Be advised that the time period for the discharge begins on the day the discharge first occurs, not on the date the discharge approval letter is issued or received.

Consistent with N.J.A.C. 7:14A-7.5(b)3 the approved discharge to ground water is related to dewatering at a contaminated site or regulated underground storage tank facility and is not to exceed 180 calendar days.

Please be aware that on May 7, 2009 the Site Remediation Reform Act (SRRA) was enacted. SRRA establishes criteria for the licensing of site remediation professionals, known as LSRP's, who will assure that contaminated sites are remediated in accordance with all prevailing statutes, regulations and guidance. The timeframes and criteria that define when a LSRP must be hired, as well as other requirements of SRRA have been reflected in the ARRCS Rule and Tech Rule adopted on November 4, 2009. These rules can be found at <http://nj.gov/dep/srp/regs/>. All parties who initiated remediation prior to November 3, 2009 will not be required to hire a LSRP to conduct the remediation right away. Remediation will follow the remediation process with traditional NJDEP oversight and approvals until 2012. All parties remediating sites on or after May 7, 2012 will be required to follow N.J.S.A. 58:10B-1.3b 1-9 and hire an LSRP.

Please be advised that based upon the Department's review of your file, it is our opinion that the remediation will not be completed, reports submitted and evaluated for this site before the May 7, 2012 deadline. Therefore it will be necessary for you to complete the remediation under the LSRP program. Information regarding opting into the LSRP program can be found at http://www.nj.gov/dep/srp/srra/l srp/opt_in.htm.

It is important to note that there are regulatory and mandatory timeframes that started March 1, 2010 that may apply to this site. Guidance for this topic can be found at http://www.nj.gov/dep/srp/srra/training/matrix/new_responsib/6_timeframe_req.pdf. Your failure to meet a mandatory timeframe will subject you to direct oversight pursuant to N.J.S.A. 58:10c-27.

Thank you for your cooperation in this matter. If you have any questions, call Cheryl Priest at (609) 292-2723.

Sincerely,

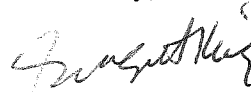

George King, Bureau Chief
Bureau of Southern Field Operations

cc: Clerk, Camden City
Camden County Health Department
Dresdner Robin
BFO File Number: 04-08-58



JH

State of New Jersey

DEPARTMENT OF ENVIRONMENTAL PROTECTION

Bureau of Southern Field Operations

401 East State Street

Mail Code 401-05

PO Box 420

Trenton, NJ 08625-0420

Phone # (609) 633-1475

Fax # (609) 984-6004

FEB - 1 REC'D

BOB MARTIN
Commissioner

CHRIS CHRISTIE
Governor

KIM GUADAGNO
Lt. Governor

January 24, 2012

Sandra Ross Johnson, Executive Director
Camden Development Agency - City Hall
520 Market Street, Suite 1300
PO Box 95120
Camden, NJ 08101

Approval

Re: Remedial Action Work Plan and New Jersey Pollutant Discharge Elimination System/Discharge to Ground Water Permit-By-Rule Request
North Front Street Associates (a.k.a. ABC Barrel Co. & AABCO Steel Drum Site)
308 - 322 North Front Street
Camden City, Camden County
Block 62.01; Lots 1 to 4
Block 62; Lots 17 to 20
Block 62.02; Lots 25 & 26
Block 65; Lots 38 & 45
SRP PI#: 006594
EA ID #: SUB110001
BFO File Number: 04-08-58

Dear Ms Ross Johnson:

The New Jersey Department of Environmental Protection (Department) has completed review of the Remedial Action Work Plan received on November 16, 2011. The Department has determined that the Remedial Action Work Plan is in compliance with the Technical Requirements for Site Remediation, N.J.A.C. 7:26E and other applicable requirements. The Department hereby approves the Remedial Action Work Plan, effective the date of this letter.

This New Jersey Pollutant Discharge Elimination System/Discharge to Ground Water (NJPDES/DGW) permit-by-rule discharge approval is hereby issued under the authority of the New Jersey Water Pollution Control Act, N.J.S.A. 58:10A-1 et seq. and the implementing regulations, N.J.A.C. 7:14A-1 et seq. Pursuant to N.J.A.C. 7:14A-22.4(b)5, a Treatment Works Approval is not

required for discharges to ground water authorized pursuant to N.J.A.C. 7:14A-7.5(b) and contained in this letter. Be advised that the time period for the discharge begins on the day the discharge first occurs, not on the date the discharge approval letter is issued or received.

Consistent with N.J.A.C. 7:14A-7.5(b)3 the approved discharge to ground water is related to dewatering at a contaminated site or regulated underground storage tank facility and is not to exceed 180 calendar days.

Please be aware that on May 7, 2009 the Site Remediation Reform Act (SRRA) was enacted. SRRA establishes criteria for the licensing of site remediation professionals, known as LSRP's, who will assure that contaminated sites are remediated in accordance with all prevailing statutes, regulations and guidance. The timeframes and criteria that define when a LSRP must be hired, as well as other requirements of SRRA have been reflected in the ARRCS Rule and Tech Rule adopted on November 4, 2009. These rules can be found at <http://nj.gov/dep/srp/regs/>. All parties who initiated remediation prior to November 3, 2009 will not be required to hire a LSRP to conduct the remediation right away. Remediation will follow the remediation process with traditional NJDEP oversight and approvals until 2012. All parties remediating sites on or after May 7, 2012 will be required to follow N.J.S.A. 58:10B-1.3b 1-9 and hire an LSRP.

Please be advised that based upon the Department's review of your file, it is our opinion that the remediation will not be completed, reports submitted and evaluated for this site before the May 7, 2012 deadline. Therefore it will be necessary for you to complete the remediation under the LSRP program. Information regarding opting into the LSRP program can be found at http://www.nj.gov/dep/srp/srra/l srp/opt_in.htm.

It is important to note that there are regulatory and mandatory timeframes that started March 1, 2010 that may apply to this site. Guidance for this topic can be found at http://www.nj.gov/dep/srp/srra/training/matrix/new_responsib/6_timeframe_req.pdf. Your failure to meet a mandatory timeframe will subject you to direct oversight pursuant to N.J.S.A. 58:10c-27.

Thank you for your cooperation in this matter. If you have any questions, call Cheryl Priest at (609) 292-2723.

Sincerely,

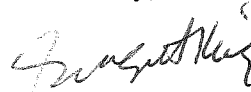

George King, Bureau Chief
Bureau of Southern Field Operations

cc: Clerk, Camden City
Camden County Health Department
Dresdner Robin
BFO File Number: 04-08-58

WELL DECOMMISSIONING REPORT

PROPERTY OWNER: CAMDEN REDEVELOPMENT AGENCY

Company/Organization: CAMDEN REDEVELOPMENT AGENCY

Address: 520 MARKET ST, 13TH FL Camden, New Jersey 08102

WELL LOCATION: ABC Barrel

Address: 314-322 N. FRONT STREET / MW1 ABC BARREL COMPANY SITE

County: Camden Municipality: Camden City Lot: 2 Block: 62.01

Easting (X): 316940 Northing (Y): 407060
Coordinate System: NJ State Plane (NAD83) - USFEET

**DATE WELL
DECOMMISSIONED:** April 4, 2017

WELL USE: MONITORING

Other Use(s): _____ **Local ID:** MW-4

Reason for Decommissioning: Project ended, no longer used

Finished Well Depth (ft.): 18 Was a New Well Drilled? N

Formation Type: Unconsolidated New Well Permit Number: _____

WELL DECOMMISSIONING INFORMATION

	Depth to Top (ft.)	Depth to Bottom (ft.)	Diameter (inches)	Material	Wgt/Rating/Screen # Used (lbs/ch no.)
Borehole					
Casing	0	3	4	PVC	sch 40
Screen	3	18	4	PVC	.010

MATERIALS USED

	Depth to Top (ft.)	Depth to Bottom (ft.)	Outer Diameter (in.)	Inner Diameter (in.)	Material		
					Bentonite (lbs.)	Neat Cement (lbs.)	Water (gal.)
Grout	0	18	4	0	10	188	16
Sand/Gravel							

ADDITIONAL INFORMATION

Obstructions: No Authorization Official: _____

Obstruction Type: _____ Authorization Number: _____

Alternative Decomm. Method? No Authorization Date: _____

Method Used _____

ATTACHMENTS: _____

WELL DECOMMISSIONING REPORT

PROPERTY OWNER: CAMDEN REDEVELOPMENT AGENCY

Company/Organization: CAMDEN REDEVELOPMENT AGENCY

Address: 520 MARKET ST, 13TH FL Camden, New Jersey 08102

WELL LOCATION: ABC Barrel

Address: 308-322 N. FRONT ST.

County: Camden Municipality: Camden City Lot: 1 Block: 62.01

Easting (X): 316921 Northing (Y): 407106
Coordinate System: NJ State Plane (NAD83) - USFEET

**DATE WELL
DECOMMISSIONED:** April 4, 2017

WELL USE: MONITORING

Other Use(s): _____ **Local ID:** MW-1

Reason for Decommissioning: Project ended, no longer used

Finished Well Depth (ft.): 25 Was a New Well Drilled? N

Formation Type: Unconsolidated New Well Permit Number: _____

WELL DECOMMISSIONING INFORMATION

	Depth to Top (ft.)	Depth to Bottom (ft.)	Diameter (inches)	Material	Wgt/Rating/Screen # Used (lbs/ch no.)
Borehole					
Casing	0	10	4	PVC	sch 40
Screen	10	25	4	PVC	.020

MATERIALS USED

	Depth to Top (ft.)	Depth to Bottom (ft.)	Outer Diameter (in.)	Inner Diameter (in.)	Material		
					Bentonite (lbs.)	Neat Cement (lbs.)	Water (gal.)
Grout	0	25	4	0	10	188	16
Sand/Gravel							

ADDITIONAL INFORMATION

Obstructions: No Authorization Official: _____

Obstruction Type: _____ Authorization Number: _____

Alternative Decomm. Method? No Authorization Date: _____

Method Used _____

ATTACHMENTS: _____

WELL DECOMMISSIONING REPORT

PROPERTY OWNER: CAMDEN REDEVELOPMENT AGENCY

Company/Organization: CAMDEN REDEVELOPMENT AGENCY

Address: 520 Market St Camden, New Jersey 08102

WELL LOCATION: ABC Barrel

Address: 330 N. FRONT ST.

County: Camden Municipality: Camden City Lot: 1 Block: 62.01

Easting (X): 316776 Northing (Y): 407146
Coordinate System: NJ State Plane (NAD83) - USFEET

**DATE WELL
DECOMMISSIONED:** April 4, 2017

WELL USE: MONITORING

Other Use(s): _____ **Local ID:** MW-2

Reason for Decommissioning: Project ended, no longer used

Finished Well Depth (ft.): 24 Was a New Well Drilled? N

Formation Type: Unconsolidated New Well Permit Number: _____

WELL DECOMMISSIONING INFORMATION

	Depth to Top (ft.)	Depth to Bottom (ft.)	Diameter (inches)	Material	Wgt/Rating/Screen # Used (lbs/ch no.)
Borehole					
Casing	0	9	4	PVC	sch 40
Screen	9	24	4	PVC	.020

MATERIALS USED

	Depth to Top (ft.)	Depth to Bottom (ft.)	Outer Diameter (in.)	Inner Diameter (in.)	Material		
					Bentonite (lbs.)	Neat Cement (lbs.)	Water (gal.)
Grout	0	24	4	0	10	188	16
Sand/Gravel							

ADDITIONAL INFORMATION

Obstructions: No Authorization Official: _____

Obstruction Type: _____ Authorization Number: _____

Alternative Decomm. Method? No Authorization Date: _____

Method Used _____

ATTACHMENTS: _____

WELL DECOMMISSIONING REPORT

PROPERTY OWNER: CAMDEN REDEVELOPMENT AGENCY

Company/Organization: CAMDEN REDEVELOPMENT

Address: 520 MARKET ST, 13TH FL Camden, New Jersey 08102

WELL LOCATION: ABC Barrel

Address: 324 N FRONT STREET

County: Camden Municipality: Camden City Lot: 4 Block: 62.01

Easting (X): 316759 Northing (Y): 407063
Coordinate System: NJ State Plane (NAD83) - USFEET

**DATE WELL
DECOMMISSIONED:** April 4, 2017

WELL USE: MONITORING

Other Use(s): _____

Local ID: MW2

Reason for Decommissioning: Project ended, no longer used

Finished Well Depth (ft.): 23

Was a New Well Drilled? N

Formation Type: Unconsolidated

New Well Permit Number: _____

WELL DECOMMISSIONING INFORMATION

	Depth to Top (ft.)	Depth to Bottom (ft.)	Diameter (inches)	Material	Wgt/Rating/Screen # Used (lbs/ch no.)
Borehole					
Casing	0	13	4	PVC	sch 40
Screen	13	23	4	PVC	.010

MATERIALS USED

	Depth to Top (ft.)	Depth to Bottom (ft.)	Outer Diameter (in.)	Inner Diameter (in.)	Material		
					Bentonite (lbs.)	Neat Cement (lbs.)	Water (gal.)
Grout	0	23	4	0	10	188	16
Sand/Gravel							

ADDITIONAL INFORMATION

Obstructions: No

Authorization Official: _____

Obstruction Type: _____

Authorization Number: _____

Alternative Decomm. Method? No

Authorization Date: _____

Method Used _____

ATTACHMENTS: _____



State of New Jersey

DEPARTMENT OF ENVIRONMENTAL PROTECTION
SITE REMEDIATION AND WASTE MANAGEMENT
OFFICE OF BROWNFIELD REUSE
MAIL CODE 401-05K
P.O. Box 420 401 E. STATE STREET
TRENTON, NEW JERSEY 08625-0420
[HTTP://WWW.STATE.NJ.US/DEP/SRP](http://www.state.nj.us/dep/srp)

CHRIS CHRISTIE
Governor

KIM GUADAGNO
Lt. Governor

BOB MARTIN
Commissioner

July 22, 2015

Sandra Ross Johnson, Executive Director
Camden Redevelopment Agency
City Hall – 13th Floor
520 Market Street
Camden, New Jersey 08101

Re: Landfill Disruption Approval
Camden City (a.k.a. Harrison Avenue) Landfill
Camden, Camden County
Facility ID No.: 133513
Approval No.: LCC150001

Dear Ms. Johnson:

Enclosed please find a Landfill Disruption Approval for the above-referenced site.

Conditions have been incorporated within this Approval that must be complied with in order for it to remain valid. The Department will consider amendment or modification of the specific terms of the conditions of this Approval if the applicant submits a written request by certified mail within twenty (20) calendar days of receipt of this letter. Said written request must clearly state the proposed amendment or modification and the factual basis for the request. This Approval is non-transferable.

If you have any questions concerning this matter, please contact me by telephone at (609) 984-2001, or by email at timothy.bartle@dep.nj.gov.

Sincerely,

Timothy T. Bartle, P.E.
Section Chief
Office of Brownfield Reuse

Enclosure

c: Ron Wienckoski, OBR
Frank McLaughlin, Case Manager OBR
Tom Farrell, Compliance and Enforcement Bureau Chief
Bill Everett, Compliance and Enforcement Supervisor

Dr. Jung H. Cho, Health Officer
Camden County Division of Health
512 Lakeland Road
Blackwood NJ, 08012

Jack Sworaski, Director
Camden County Division of Environmental Affairs
520 North Newton Lake Drive
Collingswood, NJ 08107

Brian Hecker, P.E.,
TRC Environmental Corporation
1601 Market Street, Suite 2555
Philadelphia, PA 19103



State of New Jersey

DEPARTMENT OF ENVIRONMENTAL PROTECTION
SITE REMEDIATION AND WASTE MANAGEMENT
OFFICE OF BROWNFIELD REUSE
MAIL CODE 401-05K
P.O. BOX 420 401 E. STATE STREET
TRENTON, NEW JERSEY 08625-0420
HTTP://WWW.STATE.NJ.US/DEP/SRP

CHRIS CHRISTIE
Governor

KIM GUADAGNO
Lt. Governor

BOB MARTIN
Commissioner

LANDFILL DISRUPTION APPROVAL

Under the provisions of N.J.S.A. 13:1E-1 et seq. known as the Solid Waste Management Act, this Landfill Disruption Approval is hereby issued to:

CAMDEN REDEVELOPMENT AGENCY

FACILITY TYPE: Sanitary Landfill
FACILITY ID NO.: 133513
PERMIT NO.: LCC090003
LOT & BLOCK NOS.: Block 809, Lots 7-9; and Block 809.01, Lot 18
MUNICIPALITY: Camden City
COUNTY: Camden

This Approval is subject to compliance with all conditions specified herein and all regulations promulgated by the Department of Environmental Protection.

This Approval shall not prejudice any claim the State may have to riparian land, nor does it permit the registrant to fill or alter or allow to be filled or altered, in any way, lands that are deemed to be riparian, wetlands, stream encroachment areas or flood plains, or that are within the Coastal Area Facility Review Act (CAFRA) zone or are subject to the Pinelands Protection Act of 1979, nor shall it allow the discharge of pollutants to waters of this state without prior acquisition of the necessary grants, permits or approvals from the Department of Environmental Protection.

July 22, 2015
Issuance Date

[Handwritten signature]
Timothy T. Bartle, P.E.
Section Chief
Office of Brownfield Reuse

Background

The Harrison Avenue Landfill was utilized as a municipal waste landfill, which was operated by the City of Camden from approximately 1952 to 1971. The aerial extent of the landfill is approximately 85 acres and bounded by Harrison Avenue and East State Street in the City of Camden. Deposited wastes consisted of household wastes, demolition debris and chemical wastes. The property is currently undergoing remedial investigation for consideration of potential redevelopment.

Purpose of Disruption

This disruption approval is issued as an extension of Approval LCC090003 and is also issued for the purpose of allowing the placement and stockpiling of dredge material from the Cooper River; and the placement of historic fill from the ABC Barrel remediation on the Harrison Avenue Landfill. The Cooper River dredge will be used as clean cover for the ABC Barrel material, as well as common fill and clean fill for the proper grading of the landfill during closure.

Extent of Operations

The following will be allowed under this disruption approval: clearing and grubbing of the access roads and stockpile areas; preparation of the stockpile areas; and placement of both materials in the designated areas. There will be separate stockpiles for unrestricted and restricted use dredge material. The total volume of the Cooper River dredge material is approximately 135,000 cubic yards and the total volume of the ABC Barrel material will be approximately 11,500 cubic yards.

This Landfill Disruption Approval is based on the following documents:

Documents that were submitted as part of the application package for Disruption Approval LCC090003:

1. Solid Waste Facility Permit Application Form signed by Sandra Ross Johnson, Executive Director, Camden Redevelopment Agency.
2. Transmittal letter addressed to Mr. Ron Wienckoski, Office of Brownfields Reuse, New Jersey Department of Environmental Protection, dated July 31, 2009, accompanied by a report entitled "Sanitary Landfill Major Disruption Application", signed by Mr. Barry J. Sutherland, P.E., Project Director, TRC and Joseph F. Ziaya, CHMM, Project Director, TRC.
3. Engineering Drawings dated July 24, 2009, signed by Barry J. Sutherland, P.E., New Jersey License No. 29135, entitled, "Harrison Avenue Landfill Stockpile Operation Plan" and "Detail Sheet".

The most recently submitted documents:

1. Interim Closure Plan dated June 2015, prepared for the Camden Redevelopment Agency by TRC Environmental Corporation, and associated drawings therein.
2. Request for the extension of the Landfill Disruption Approval LCC090003 dated July 9, 2015 along with a drawing titled, Harrison Avenue Landfill Cooper Dredge Material Stockpile Plan dated July 2015.

Approval Conditions

The conditions of this Approval are found in the attached document entitled "CAMDEN REDEVELOPMENT AGENCY, 133513 LCC0150001 SW Landfill (Class C) Closure -Disruption Approval, Requirements Report."

CAMDEN REDEVELOPMENT AGENCY
133513 LCC150001 SW Landfill (Class C) Closure -Disruption Approval
Requirements Report

Subject Item: PI 133513 -

1. This disruption approval is issued as an extension of Approval LCC090003, and for the purpose of allowing the placement and stockpiling of dredge material from the Cooper River as depicted on a drawing included in the Request for Extension, dated July 9, 2015, titled "Harrison Avenue Landfill Cooper Dredge Material Stockpile Plan", dated July 2015; and the placement of historic fill from the ABC Barrel remediation on the Harrison Avenue Landfill as depicted on drawings 6-8 included in the June 2015 Interim Closure Plan, signed and sealed by Howard F. Nichols III, P.E., of TRC Environmental Corporation, NJ License No. 24GE04683300. The Cooper River dredge will be used as clean cover for the ABC Barrel material, as well as common fill and clean fill for the proper grading of the landfill for closure. The total volume of the Cooper River dredge material is approximately 135,000 cubic yards and the total volume of the ABC Barrel material will be approximately 11,500 cubic yards. [N.J.A.C. 7:26- 2A.8(j)]
2. A professional engineer (P.E.) shall be on site during hours of operation making sure that the material coming into the site is from the Cooper River dredge project or from ABC Barrel and that the material is acceptable. Material will be transported to the site through the southwest gate along Harrison Avenue. Mount Construction shall weigh the Cooper River dredge material at the point of generation and provide the weigh tickets to the P.E. at the landfill. The P.E. shall keep track of the truckloads of ABC Barrel material received at the landfill.

A minimum of six (6) inches of the unrestricted use dredge material shall be placed over any exposed waste in the stockpile areas at the end of each workweek or more frequently if odors or vectors are a problem. Any waste still exposed in the stockpile area after stockpiling is completed shall be covered by a minimum of six (6) inches of the unrestricted use dredge material.

There will be separate stockpiles for unrestricted and restricted use dredge material. A demarcation layer should be placed under the Cooper River dredge material. If no demarcation layer is used the bottom six (6) inch layer of the dredge material shall be left in place and shall not be used as clean or common fill during landfill closure activities.

The ABC barrel material shall be placed in the area shown on Figure 6 of the Interim Closure Plan and the unrestricted use dredge shall be used for the 12-inch cover layer. All material shall be seeded and vegetated to prevent erosion. [N.J.A.C. 7:26- 2A.8(j)]

3. Methods of effectively controlling dust shall be implemented in order to prevent offsite migration. [N.J.A.C. 7:26-2A.8(j)]
4. Noise control measures shall be implemented so that noise levels generated by site activities do not exceed the standards set forth by the New Jersey Noise Control Regulations under N.J.A.C. 7:29-1.2. [N.J.A.C. 7:26-2A.8(j)]
5. The disruption activities shall be conducted in strict compliance with the air emission standards of the Department. The disruption activities shall not result in air contaminants to be emitted in violation of N.J.A.C. 7:27-5.2(a). [N.J.A.C. 7:26-2A.8(j)]
6. Vectors shall be controlled by the application of cover soil. If vectors persist, a control program shall be implemented in compliance with the requirements of the New Jersey Pesticide Control Code, N.J.A.C. 7:30, by an applicator of pesticides, certified in accordance with the New Jersey Pesticide Control Code, N.J.A.C. 7:30. [N.J.A.C. 7:26-2A.8(j)]

CAMDEN REDEVELOPMENT AGENCY
133513 LCC150001 SW Landfill (Class C) Closure -Disruption Approval
Requirements Report

Subject Item: PI 133513 -

7. An adequate water supply and adequate fire-fighting equipment shall be maintained at the facility or be readily available to extinguish any and all types of fires. The telephone numbers of local fire, police, ambulance and hospital facilities shall be known in advance. [N.J.A.C. 7:26-2A.8(j)]
8. In the event that chemical or hazardous waste materials are encountered during the disruption, operations shall cease immediately and the area shall be secured. The contractor shall notify the Department by calling the Environmental Action Hot Line at 1-877-WARN DEP and take all necessary precautions for the safe removal and disposal of the waste to an approved facility under the direction of this Department. [N.J.A.C. 7:26-2A.8(j)]
9. The contractor shall follow the Occupational Safety and Health Administration (OSHA) standards and the Health and Safety Plan (HASP) submitted as part of the application for a Minor Disruption that was approved on February 6, 2009 during all on-site activities for the safety of employees and for others entering the site, until a new HASP is in place. A copy of the new HASP shall be submitted to the Department. A copy of the operating safety procedures shall be posted on-site. [N.J.A.C. 7:26- 2A.8(j)]
10. Departmental inspectors shall have the right to enter and inspect the facility at any time. The right to inspect includes, but is not limited to: a. Sampling materials on site; b. Photographing any portion of the facility; c. Investigating an actual or suspected source of pollution of the environment; d. Ascertaining compliance or non-compliance with the statutes, rules or regulations of the Department, including conditions of any permit or approval issued by the Department; and e. Reviewing and copying all applicable records, which shall be furnished upon request and made available at all reasonable times for inspection. [N.J.A.C. 7:26-2A.8(j)]
11. This Approval shall have no expiration date. [N.J.A.C. 7:26- 2A.8(j)]
12. Failure to comply with any or all conditions of this Approval will result in the NJDEP seeking relief under the Solid Waste Management Act, N.J.S.A. 13:1E-1 et seq. Specifically, each day of failure to so comply shall constitute a separate violation on the basis of which a penalty shall be assessed pursuant to N.J.S.A. 13:1E-9 and may subject the facility to regulation as a solid waste facility pursuant to N.J.S.A. 13:1E-1 et seq. and N.J.A.C. 7:26-1 et seq. [N.J.A.C. 7:26-2A.8(j)]
13. The issuance of this Approval and the conditions of operation identified herein shall not be interpreted as relieving the applicant of his responsibility to secure and maintain all other applicable federal, State and local permits or similar forms of authorization relating to the construction and/or operation of this facility. [N.J.A.C. 7:26-2A.8(j)]
14. This authorization is not transferable. [N.J.A.C. 7:26-2A.8(j)]
15. The Camden Redevelopment Agency shall establish an interest-bearing account with an accredited financial institution that shall constitute an escrow account for the post-closure monitoring and operating costs of the landfill. All payments received for material accepted at the landfill shall be deposited in this account.

A copy of the standard escrow agreement provided by the Department may be obtained from the Department of Environmental Protection, Division of Solid and Hazardous Waste, Bureau of Solid Waste Planning and Licensing, Mail Code: 401-02C, P.O. Box 420, 401 East State Street, Trenton, NJ 08625-0420 Attention: Landfill Closure Escrow Account. [N.J.A.C. 7:26- 2A.9(g)]

Charles Metzger

From: DEP SRPGIS <SRPGIS@dep.nj.gov>
Sent: Wednesday, April 18, 2018 5:53 PM
To: Charles Metzger
Subject: Re: 006594, DN (Deed Notice Submittal Date: 4/14/2018 7:48:45 PM)

SRP successfully processed the GIS deliverable attached to the 04/14/2018 email referenced above. The Deed Notice shape was created on 04/16/2018 for Preferred ID 006594. The shape(s) were extracted from:

006594_041418DN.shp

The boundary of the institutional control will be reviewed by the appropriate SRP program at a later date.

(DEP Submission ID: 2471)

Charles Metzger

From: DEP SRPEDD <SRPEDD@dep.nj.gov>
Sent: Monday, April 16, 2018 3:40 PM
To: Charles Metzger
Subject: 769654, LSR120001, 769654, HB225086, (Directory: RA-TSOIL) - Passed
Attachments: DTST.TXT; EDSA_Error_Log.html; erdstst-7-1-8.txt; erresult-7-1-8.txt; ersample-7-1-8.txt; HZRESULT.TXT; HZSAMPLE.TXT; rstp-7-1-8.txt; SampleLoc-7-1-8.KML

The EDD submission via email from (CMetzger@brsinc.com) on (4/13/2018 10:18:34 PM) with the subjectline "769654".

The following identifiers were in the DTST file:

- Directory: RA-TSOIL
- DESC: Front St Property, Topsoil samples
- SRPID: 769654
- Submit Date: 4/13/2018

This submission has been issued an SRP Catalog ID: HB225086

Submission status: **Passed.**

Please do **not** resubmit.

EDD data deliverable must be submitted only once.

- To fulfill Key Document requirements attach only a copy of this email as an appendix to the document.
- Do **not** resubmit any approved EDD deliverable as part of a portal submission.

Email ID: OEM_12179
Sub ID: SUB_56061

Charles Metzger

From: DEP SRPEDD <SRPEDD@dep.nj.gov>
Sent: Monday, April 16, 2018 3:40 PM
To: Charles Metzger
Subject: 006594, LSR120002, 95-09-14-1206-53, HB225087, (Directory: RA-TSOIL) - Passed
Attachments: DTST.TXT; EDSA_Error_Log.html; erdstst-7-1-8.txt; erresult-7-1-8.txt; ersample-7-1-8.txt; HZRESULT.TXT; HZSAMPLE.TXT; rstp-7-1-8.txt; SampleLoc-7-1-8.KML

The EDD submission via email from (CMetzger@brsinc.com) on (4/13/2018 10:16:26 PM) with the subjectline "006594, 95-09-14-1206-53".

The following identifiers were in the DTST file:

- Directory: RA-TSOIL
- DESC: ABC Barrel Site, Topsoil samples
- SRPID: 6594
- Submit Date: 4/13/2018

This submission has been issued an SRP Catalog ID: HB225087

Submission status: **Passed.**

Please do **not** resubmit.

EDD data deliverable must be submitted only once.

- To fulfill Key Document requirements attach only a copy of this email as an appendix to the document.
- Do **not** resubmit any approved EDD deliverable as part of a portal submission.

Email ID: OEM_12180
Sub ID: SUB_56062

Charles Metzger

From: srpedd@dep.nj.gov
Sent: Thursday, July 27, 2017 6:18 PM
To: Charles Metzger
Cc: hazsite@dep.nj.gov
Subject: 006594, 95-09-14-1206-53, HB210583 Passed
Attachments: erdst-7-1-8.txt; erresult-7-1-8.txt; ersample-7-1-8.txt; 950914120653_20170228_20170329.KML; DTST.TXT; EDSA_Error_Log.html; HZRESULT.TXT; HZSAMPLE.TXT

The EDD submission shown below was processed 07/27/2017. This submission has passed and is cataloged in our system.

The email containing your EDD had the subject line of: RE: 006594, 95-09-14-1206-53, HB210478 Failed. When resubmitting, reply to this email ONLY. DO NOT CHANGE SUBJECT LINE.
it was sent on:

Your submission has been issued an SRP Catalog ID: HB210583 Thank You

The following identifiers were in the DTST file:

Directory: RA-PX

DESC: ABC Barrel Company Site, RA post-excavation samples

SRPID: 95-09-14-1206-53

Submit Date: 7/26/2017

If you are using the email to process your EDD with your key document, include a copy of this email with your key document package.

This is an automated message.

Charles Metzger

From: DEP SRPEDD <SRPEDD@dep.nj.gov>
Sent: Monday, April 16, 2018 3:39 PM
To: Charles Metzger
Subject: 769626, LSR120001, 769626, HB225084, (Directory: RA-TSOIL) - Passed
Attachments: DTST.TXT; EDSA_Error_Log.html; erdstst-7-1-8.txt; erresult-7-1-8.txt; ersample-7-1-8.txt; HZRESULT.TXT; HZSAMPLE.TXT; rstp-7-1-8.txt; SampleLoc-7-1-8.KML

The EDD submission via email from (CMetzger@brsinc.com) on (4/13/2018 10:21:13 PM) with the subjectline "769626".

The following identifiers were in the DTST file:

- Directory: RA-TSOIL
- DESC: N Second St Property, Topsoil samples
- SRPID: 769626
- Submit Date: 4/13/2018

This submission has been issued an SRP Catalog ID: HB225084

Submission status: **Passed.**

Please do **not** resubmit.

EDD data deliverable must be submitted only once.

- To fulfill Key Document requirements attach only a copy of this email as an appendix to the document.
- Do **not** resubmit any approved EDD deliverable as part of a portal submission.

Email ID: OEM_12177
Sub ID: SUB_56059

Charles Metzger

From: DEP SRPEDD <SRPEDD@dep.nj.gov>
Sent: Monday, April 16, 2018 3:39 PM
To: Charles Metzger
Subject: 769582, LSR120001, 769582, HB225085, (Directory: RA-TSOIL) - Passed
Attachments: DTST.TXT; EDSA_Error_Log.html; erdstst-7-1-8.txt; erresult-7-1-8.txt; ersample-7-1-8.txt; HZRESULT.TXT; HZSAMPLE.TXT; rstp-7-1-8.txt; SampleLoc-7-1-8.KML

The EDD submission via email from (CMetzger@brsinc.com) on (4/13/2018 10:20:02 PM) with the subjectline "769582".

The following identifiers were in the DTST file:

- Directory: RA-TSOIL
- DESC: Penn Street Site, Topsoil samples
- SRPID: 769582
- Submit Date: 4/13/2018

This submission has been issued an SRP Catalog ID: HB225085

Submission status: **Passed.**

Please do **not** resubmit.

EDD data deliverable must be submitted only once.

- To fulfill Key Document requirements attach only a copy of this email as an appendix to the document.
- Do **not** resubmit any approved EDD deliverable as part of a portal submission.

Email ID: OEM_12178
Sub ID: SUB_56060

Charles Metzger

From: DEP SRPGIS <SRPGIS@dep.nj.gov>
Sent: Monday, April 16, 2018 1:33 PM
To: Charles Metzger
Subject: Re: 769582, CEA (CEA Submittal Date: 4/15/2018 11:06:07 PM)

SRP successfully processed the GIS deliverable attached to the 04/15/2018 email referenced above. The proposed CEA shape was created on 04/16/2018 for Preferred ID 769582. The shape(s) were extracted from:

769582_041518CEA.shp

The boundary of the institutional control will be reviewed by the appropriate SRP program and the CEA will be established at a later date.

(DEP Submission ID: 5710)

Charles Metzger

From: DEP SRPGIS <SRPGIS@dep.nj.gov>
Sent: Monday, April 16, 2018 1:33 PM
To: Charles Metzger
Subject: Re: 769654, CEA (CEA Submittal Date: 4/15/2018 11:04:49 PM)

SRP successfully processed the GIS deliverable attached to the 04/15/2018 email referenced above. The proposed CEA shape was created on 04/16/2018 for Preferred ID 769654. The shape(s) were extracted from:

769654_041518CEA.shp

The boundary of the institutional control will be reviewed by the appropriate SRP program and the CEA will be established at a later date.

(DEP Submission ID: 5711)

Charles Metzger

From: DEP SRPGIS <SRPGIS@dep.nj.gov>
Sent: Monday, April 16, 2018 1:33 PM
To: Charles Metzger
Subject: Re: 006594, CEA (CEA Submittal Date: 4/15/2018 10:54:37 PM)

SRP successfully processed the GIS deliverable attached to the 04/15/2018 email referenced above. The proposed CEA shape was created on 04/16/2018 for Preferred ID 006594. The shape(s) were extracted from:

006594_041518CEA.shp

The boundary of the institutional control will be reviewed by the appropriate SRP program and the CEA will be established at a later date.

(DEP Submission ID: 5712)

Charles Metzger

From: DEP SRPGIS <SRPGIS@dep.nj.gov>
Sent: Monday, April 16, 2018 1:33 PM
To: Charles Metzger
Subject: Re: 769626, CEA (CEA Submittal Date: 4/15/2018 11:07:45 PM)

SRP successfully processed the GIS deliverable attached to the 04/15/2018 email referenced above. The proposed CEA shape was created on 04/16/2018 for Preferred ID 769626. The shape(s) were extracted from:

769626_041518CEA.shp

The boundary of the institutional control will be reviewed by the appropriate SRP program and the CEA will be established at a later date.

(DEP Submission ID: 5709)

**APPENDIX B
PUBLIC NOTIFICATION**





New Jersey Department of Environmental Protection
Site Remediation Program

PUBLIC NOTIFICATION AND OUTREACH

Date Stamp
 (For Department use only)

SECTION A. SITE LOCATION

Site Name: Centennial Avenue Park, Front Street Property, Penn Street Property, North Second Street Property

List all AKAs: ABC Barrel, AABCO Steel Drum, Container Recyclers, North Front Associates

Remediated as a
 single site,
 subsequently split
 into 4 sites

Street Address: Centennial Ave, formerly 308-322 North Front Street

Municipality: City of Camden (Township, Borough or City)

County: Camden Zip Code: 08102

Mailing Address if different than street address: CRA, 520 Market Street, City Hall, Suite 1300, Camden, NJ 08101

Program Interest (PI) Number(s): 006594, 769654, 769582, 769626

Case Tracking Number(s) for this submission: 95-09-14-1206-53

Date Remediation Initiated Pursuant to N.J.A.C. 7:26C-2: 09/14/1995

State Plane Coordinates for a central location at the site: Easting: 316913 Northing: 407086

Municipal Block(s) and Lot(s):

Block # 62.01 Lot # 1, 2, 3, 4 Block # _____ Lot # _____

Block # 62.02 Lot # 24, 25 **Shown on Camden Plan of Site as Block 62, lots 24 & 25**

Block # 62 Lot # 17, 21, 22 & 23 **Camden Plan of Site as Block 62, lots 17, 18, 19, 20**

Block # **Part of site is a municipal ROW with no block/lot** Lot # _____

SECTION B. NOTIFICATION INFORMATION

1. Indicate the type of Public Notification:

Initial Update

2. Public notification was provided via: (Check all that apply)

Sign..... Yes No

Letter..... Yes No

Fact sheet..... Yes No

3. Were materials produced in a language other than English? Yes No

If "Yes," in what other language was notification prepared? Spanish

4. Were copies provided to municipal clerk, local/county health dept., and local health agency? Yes No

5. Did you provide an electronic copy of all required submittals? **Current submittal** Yes No

6. Was public notification conducted using an alternate plan and is the rationale for this plan included? Yes No

7. Was additional public outreach conducted due to the NJDEP's determination of substantial public interest? Yes No

SECTION C. PERSON RESPONSIBLE FOR CONDUCTING THE REMEDIATION INFORMATION AND CERTIFICATION

Full Legal Name of the Person Responsible for Conducting the Remediation: City of Camden Redevelopment Agency

Representative First Name: Olivette Representative Last Name: Simpson

Title: Interim Executive Director

Phone Number: (856) 757-7600 Ext: _____ Fax: _____

Mailing Address: 520 Market Street, City Hall, Suite 1300

City/Town: Camden State: NJ Zip Code: 08101

Email Address: OISimpso@ci.camden.nj.us

This certification shall be signed by the person responsible for conducting the remediation who is submitting this notification in accordance with Administrative Requirements for the Remediation of Contaminated Sites rule at N.J.A.C. 7:26C-1.5(a).

I certify under penalty of law that I have personally examined and am familiar with the information submitted herein, including all attached documents, and that based on my inquiry of those individuals immediately responsible for obtaining the information, to the best of my knowledge, I believe that the submitted information is true, accurate and complete. I am aware that there are significant civil penalties for knowingly submitting false, inaccurate or incomplete information and that I am committing a crime of the fourth degree if I make a written false statement which I do not believe to be true. I am also aware that if I knowingly direct or authorize the violation of any statute, I am personally liable for the penalties.

Signature:  Date: 4-20-18

Name/Title: Olivette Simpson / Interim Executive Director

SECTION D. LICENSED SITE REMEDIATION PROFESSIONAL INFORMATION AND STATEMENT

LSRP ID Number: 668158

First Name: Charles

Last Name: Metzger

Phone Number: (856) 964-6456

Ext: 6860

Fax: (732) 782-0404

Mailing Address: PO Box 2293

City/Town: Medford Lakes

State: NJ

Zip Code: 08055

Email Address: cmetzger@brsinc.com

This statement shall be signed by the LSRP who is submitting this notification in accordance with N.J.S.A. 58:10C-14, and N.J.S.A. 58:10B-1.3b(1) and (2).

I certify that I am a Licensed Site Remediation Professional authorized pursuant to N.J.S.A. 58:10C to conduct business in New Jersey. As the Licensed Site Remediation Professional of record for this remediation, I:

[SELECT ONE OR BOTH OF THE FOLLOWING AS APPLICABLE]:

directly oversaw and supervised all of the referenced remediation, and/or

personally reviewed and accepted all of the referenced remediation presented herein.

I believe that the information contained herein, and including all attached documents, is true, accurate and complete.

It is my independent professional judgment and opinion that the remediation conducted at this site, as reflected in this submission to the Department, conforms to, and is consistent with, the remediation requirements in N.J.S.A. 58:10C-14.

My conduct and decisions in this matter were made upon the exercise of reasonable care and diligence, and by applying the knowledge and skill ordinarily exercised by licensed site remediation professionals practicing in good standing, in accordance with N.J.S.A. 58:10C-16, in the State of New Jersey at the time I performed these professional services.

I am aware pursuant to N.J.S.A. 58:10C-17 that for purposely, knowingly or recklessly submitting false statement, representation or certification in any document or information submitted to the board or Department, etc., that there are significant civil, administrative and criminal penalties, including license revocation or suspension, fines and being punished by imprisonment for conviction of a crime of the third degree.

LSRP Signature: 

Date: 4/23/18

LSRP Name/Title: Charles V. Metzger/Environmental Project Manag

Company Name: Brownfield Redevelopment Solutions, Inc.

Completed forms should be sent to:

Bureau of Case Assignment & Initial Notice
Site Remediation Program
NJ Department of Environmental Protection
401-05H
PO Box 420
Trenton, NJ 08625-0420

Photographs of Public Notice Signs

ABC Barrel Site, 121-123 Penn St., 324-330 N. Front St. and 300 Block of N. 2nd Street

City of Camden, Camden County, NJ

NJDEP SRP PI# 006594







March 27, 2017

Luis Pastoriza, M.S.M., R.M.C.
Municipal Clerk & Registrar
Office of the City Clerk
520 Market Street
City Hall, Room 105
P.O. Box 95120
Camden, NJ 08101-5120

Public Notification Activities and Site Information
ABC Barrel Site, 121-123 Penn St., 324-330 N. Front St. and 300 Block of N. 2nd Street
City of Camden, Camden County, NJ
NJDEP SRP PI# 006594

Mr. Pastoriza:

Brownfield Redevelopment Solutions, Inc. (BRS), on behalf of the Camden Redevelopment Agency (CRA), submits this letter pursuant to the Administrative Requirements for the Remediation of Contaminated Sites, New Jersey Administrative Code (N.J.A.C.) 7:26C-1.7(h)2iii to notify you regarding the environmental cleanup activities being conducted at the ABC Barrel Site located at 121-123 Penn St., 324-330 N. Front St., and 300 Block of N. 2nd Street in the City of Camden, Camden County. A description of recent public notice activities and accompanying information regarding the site and site environmental conditions is provided in this letter.

Public Notice Activities

The CRA installed signs at the site to notify the public of cleanup activities and to provide the public with relevant contact information. Two signs, one in English and one in Spanish, were installed at the site along North Front Street. Photographs of the public notice signs are attached.

Site Information

The CRA is conducting environmental cleanup at the site, with significant support provided by three U.S. Environmental Protection Agency Brownfields Cleanup Grants as well as State NJDEP Hazardous Discharge Site Remediation Fund monies. Cleanup activities include excavation of contaminated materials to various depths and backfill with certified clean soil as well as construction of a soil cap for the dedicated open space portion of the site.

The CRA intends to continue to promote and facilitate community involvement with this environmental cleanup and to implement NJDEP's Notification and Public Outreach regulations. Please contact Charles Metzger, LSRP, with any questions regarding this project at 856-964-6456 x 6860 or Charles@brsinc.com.

Sincerely,

Brownfield Redevelopment Solutions, Inc.



Christine Polit

Attachment

cc: Mr. James Harveson, CRA
Mr. Charles Metzger, BRS, Inc.



739 Stokes Road, Units A & B, Medford, NJ 08055
PO Box 2293, Medford Lakes, NJ 08055
t (856) 964-6456 • f (732) 782-0404 • www.BRSinc.com



March 27, 2017

Ann D. Biondi
Director, Camden County Department of Health and Human Services
DiPiero Center
512 Lakeland Road Suite 501
Blackwood, NJ 08012

Public Notification Activities and Site Information
ABC Barrel Site, 121-123 Penn St., 324-330 N. Front St. and 300 Block of N. 2nd Street
City of Camden, Camden County, NJ
NJDEP SRP PI# 006594

Ms. Biondi:

Brownfield Redevelopment Solutions, Inc. (BRS), on behalf of the Camden Redevelopment Agency (CRA), submits this letter pursuant to the Administrative Requirements for the Remediation of Contaminated Sites, New Jersey Administrative Code (N.J.A.C.) 7:26C-1.7(h)2iii to notify you regarding the environmental cleanup activities being conducted at the ABC Barrel Site located at 121-123 Penn St., 324-330 N. Front St., and 300 Block of N. 2nd Street in the City of Camden, Camden County. A description of recent public notice activities and accompanying information regarding the site and site environmental conditions is provided in this letter.

Public Notice Activities

The CRA installed signs at the site to notify the public of cleanup activities and to provide the public with relevant contact information. Two signs, one in English and one in Spanish, were installed at the site along North Front Street. Photographs of the public notice signs are attached.

Site Information

The CRA is conducting environmental cleanup at the site, with significant support provided by three U.S. Environmental Protection Agency Brownfields Cleanup Grants as well as State NJDEP Hazardous Discharge Site Remediation Fund monies. Cleanup activities include excavation of contaminated materials to various depths and backfill with certified clean soil as well as construction of a soil cap for the dedicated open space portion of the site.

The CRA intends to continue to promote and facilitate community involvement with this environmental cleanup and to implement NJDEP's Notification and Public Outreach

regulations. Please contact Charles Metzger, LSRP, with any questions regarding this project at 856-964-6456 x 6860 or Charles@brsinc.com.

Sincerely,

Brownfield Redevelopment Solutions, Inc.



Christine Polit

Attachment

cc: Mr. James Harveson, CRA
Mr. Charles Metzger, BRS, Inc.
Mr. Pascal Nwako, County Health Officer, Camden County DHHS



739 Stokes Road, Units A & B, Medford, NJ 08055
PO Box 2293, Medford Lakes, NJ 08055
t (856) 964-6456 • f (732) 782-0404 • www.BRSinc.com

APPENDIX C
MATERIAL DISPOSAL DOCUMENTATION



APPENDIX C-1
CONTAMINATED SOIL DISPOSAL



JDD21

SHIPPING DOCUMENT

Beneficial Soil Solutions, Inc. 12170 Mount Albert Road Ellicott City, MD 21042

410.531.3205

BILL OF LADING # /
DATE:
Re-Use #: 030417

GENERATOR/SITE INFORMATION

NAME: Camden Redevelopment Agency
ADDRESS: Former ABC Barrel
N Front St & Centennial Avenue
Camden, NJ 08102

TRANSPORTER INFORMATION

NAME: J&D Trucking
ADDRESS: 3526 NW Boulevard
Vineland, NJ 08360
Phone: 856.691.5145

Contact: Julian Heal Phone: 215.870.5092

Driver Site Signature Release: _____

DESTINATION INFORMATION

NAME: Cape May M.U.A.
ADDRESS: 2050 Route 610
Woodbine, NJ 08270

Truck# 21 TAG# AL47L

Driver responsible for Compliance with DOT and Weight Laws

SCALE HOUSE PHONE: 609.861.5701 ext 213

GENERATOR STATEMENT

I am the authorized agent of the Generator for the materials offered on this Acceptance Ticket for transportation and recycling, and by my signature below, certify that the materials described below are non-hazardous as previously described in Beneficial Soil Solutions Inc (BSSI) approval form. Their approval process has resulted in the issuance of the above referenced BSSI.

Printed Name: Scott Moore Signature: [Signature] Date: 3/23/17
As Agent for Generator

TRANSPORTER STATEMENT

I hereby certify that the materials represented by this bill of lading were loaded at the above Generator address and will be delivered to the destination listed above without incident and/or tampering of any kind.

Printed Name: Fernando Bull Signature: [Signature] Date: 3/23/17

MATERIAL DESCRIPTION SOIL

Received by: OMCMUA
Printed Name: Brenda Blizzard
Signature: [Signature]
Date: 3-23-17

Gross weight: 82060
Tare weight: 26460
Net weight: 55600

Ton 27.80

SHIPPING DOCUMENT

JDa

Beneficial Soil Solutions, Inc. 12170 Mount Albert Road Ellicott City, MD 21042

410. 531. 3205

BILL OF LADING # 2
DATE:
Re-Use #: 030417

GENERATOR/SITE INFORMATION

TRANSPORTER INFORMATION

NAME: Camden Redevelopment Agency

NAME: J&D Trucking

ADDRESS: Former ABC Barrel
N Front St & Centennial Avenue
Camden, NJ 08102

ADDRESS: 3526 NW Boulevard
Vineland, NJ 08360
Phone: 856.691.5145

Contact: Julian Heal Phone: 215.870.5092

Driver Site Signature Release: R. Lopez

DESTINATION INFORMATION

Truck#

25

TAG#

AS670W

NAME: Cape May M.U.A.

Driver responsible for Compliance with DOT and Weight Laws

ADDRESS: 2050 Route 610
Woodbine, NJ 08270

SCALE HOUSE PHONE: 609.861.5701 ext 213

GENERATOR STATEMENT

I am the authorized agent of the Generator for the materials offered on this Acceptance Ticket for transportation and recycling, and by my signature below, certify that the materials described below are non-hazardous as previously described in Beneficial Soil Solutions Inc. (BSSI) approval form. Their approval process has resulted in the issuance of the above referenced BSSI.

Printed Name:

Scott Moor

Signature: [Signature]

Date:

3/23/17

As Agent for Generator

TRANSPORTER STATEMENT

I hereby certify that the materials represented by this bill of lading were loaded at the above Generator address, and will be delivered to the destination listed above without incident and/or tampering of any kind.

Printed Name:

Key Lopez

Signature: [Signature]

Date:

3/23/17

MATERIAL DESCRIPTION

SOIL

Received by:

CMCMUA

Gross weight:

79220

Printed Name:

Brenda Blizzard

Tare weight:

26900

Signature:

Brenda Blizzard

Net weight:

52320

Date:

3-23-17

ton: 26.16

JD 25

SHIPPING DOCUMENT

Beneficial Soil Solutions, Inc. 12170 Mount Albert Road Ellicott City, MD 21042

410. 531. 3205

BILL OF LADING #

DATE:

Re-Use #: 030417

3

GENERATOR/SITE INFORMATION

NAME: Camden Redevelopment Agency
ADDRESS: Former ABC Barrel
N Front St & Centennial Avenue
Camden, NJ 08102

Contact: Julian Heal Phone: 215.870.5092

TRANSPORTER INFORMATION

NAME: J&D Trucking
ADDRESS: 3526 NW Boulevard
Vineland, NJ 08360
Phone: 856.691.5145

Driver Site Signature Release: R. Lopez

DESTINATION INFORMATION

NAME: Cape May M.U.A.
ADDRESS: 2050 Route 610
Woodbine, NJ 08270

Truck# 25 TAG# AS678M

Driver responsible for Compliance with DOT and Weight Laws

SCALE HOUSE PHONE: 609.861.5701 ext 213

GENERATOR STATEMENT

I am the authorized agent of the Generator for the materials offered on this Acceptance Ticket for transportation and recycling, and by my signature below, certify that the materials described below are non-hazardous as previously described in Beneficial Soil Solutions Inc. (BSSI) approval form. Their approval process has resulted in the issuance of the above referenced BSSI.

Printed Name: Scott Moor
As Agent for Generator

Signature: [Signature]

Date: 3, 23, 17

TRANSPORTER STATEMENT

I hereby certify that the materials represented by this bill of lading were loaded at the above Generator address and will be delivered to the destination listed above without incident and/or tampering of any kind.

Printed Name: Rev Lopez

Signature: [Signature]

Date: 3, 23, 17

MATERIAL DESCRIPTION

SOIL

Received by: CMCMLA
Printed Name: Brenda Blizzard
Signature: [Signature]
Date: 3-23-17

Gross weight: 81040
Tare weight: 26680
Net weight: 54360

Ton 27.18

SHIPPING DOCUMENT

JD 21

Beneficial Soil Solutions, Inc. 12170 Mount Albert Road Ellicott City, MD 21042

410. 531. 3205

BILL OF LADING #
DATE:
Re-Use #: 030417

4

GENERATOR/SITE INFORMATION

TRANSPORTER INFORMATION

NAME: Camden Redevelopment Agency
ADDRESS: Former ABC Barrel
N Front St & Centennial Avenue
Camden, NJ 08102

NAME: J&D Trucking
ADDRESS: 3526 NW Boulevard
Vineland, NJ 08360
Phone: 856.691.5145

Contact: Julian Heal Phone: 215.870.5092

Driver Site Signature Release: 

DESTINATION INFORMATION

Truck# 26 TAG# ALCF7L

NAME: Cape May M.U.A.
ADDRESS: 2050 Route 610
Woodbine, NJ 08270

Driver responsible for Compliance with DOT and Weight Laws

SCALE HOUSE PHONE: 609.861.5701 ext 213

GENERATOR STATEMENT

I am the authorized agent of the Generator for the materials offered on this Acceptance Ticket for transportation and recycling, and by my signature below, certify that the materials described below are non-hazardous as previously described in Beneficial Soil Solutions Inc. (BSSI) approval form. Their approval process has resulted in the issuance of the above referenced BSSI.

Printed Name: SCOTT MOORE
As Agent for Generator

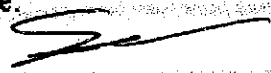
Signature: 

Date: 3/23/17

TRANSPORTER STATEMENT

I hereby certify that the materials represented by this bill of lading were loaded at the above Generator address and will be delivered to the destination listed above without incident and/or tampering of any kind.

Printed Name: FERNANDO BACA

Signature: 

Date: 3/23/17

MATERIAL DESCRIPTION

SOIL

Received by: CMMUA
Printed Name: BONNIE WOOD
Signature: BONNIE WOOD
Date: 3/23/17

Gross weight: 79140
Tare weight: 26260
Net weight: 52880
TON 26.44

SHIPPING DOCUMENT

JD25

Beneficial Soil Solutions, Inc. 12170 Mount Albert Road Ellicott City, MD 21042

410.531.3205

BILL OF LADING #

DATE:

Re-Use #: 030417

GENERATOR/SITE INFORMATION

TRANSPORTER INFORMATION

NAME: Camden Redevelopment Agency

NAME: J&D Trucking

ADDRESS: Former ABC Barrel
N Front St & Centennial Avenue
Camden, NJ 08102

ADDRESS: 3526 NW Boulevard
Vineland, NJ 08360

Phone: 856.691.5145

Contact: Julian Heal Phone: 215.870.5092

Driver Site Signature Release: 

DESTINATION INFORMATION

Truck#

25

TAG#

AS670N

NAME: Cape May M.U.A.

Driver responsible for Compliance with DOT and Weight Laws

ADDRESS: 2050 Route 610
Woodbine, NJ 08270

SCALE HOUSE PHONE: 609.861.5701 ext 213

GENERATOR STATEMENT

I am the authorized agent of the Generator for the materials offered on this Acceptance Ticket for transportation and recycling, and by my signature below, certify that the materials described below are non-hazardous as previously described in Beneficial Soil Solutions Inc. (BSSI) approval form. Their approval process has resulted in the issuance of the above referenced BSSI.

Printed Name:

Scott Moore

Signature:

Date:

3/23/17

As Agent for Generator

TRANSPORTER STATEMENT

I hereby certify that the materials represented by this bill of lading were loaded at the above Generator address and will be delivered to the destination listed above without incident and/or tampering of any kind.

Printed Name:

Ray Lopez

Signature:

Date:

3-23-17

MATERIAL DESCRIPTION

SOIL

Received by: CMC MUA

Gross weight:

80200

Printed Name: BONNIE WOOD

Tare weight:

26500

Signature: Bonnie Wood

Date:

3/23/17

Net weight:

53700

Ton 26.85

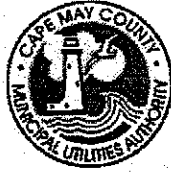

CAPE MAY COUNTY MUA - LANDFILL
 2050 COUNTY ROUTE 610
 WOODBINE, NJ 08270
<http://www.cmcMua.com>

Facility ID: 0511C

Ticket: 50026130
 Date: 3/23/2017
 Time: 14:16:30 - 14:32:13

			Scale
Gross:	80200 LB	In	Scale IN
Tare:	26500 LB	Out	Scale OUT
Net:	53700 LB		

Truck: JD25
 Customer: SW000257/BENEFICIAL SOIL SOL License: AS678M
 Carrier: SW000257/BENEFICIAL SOIL Truck Type: DUMP TRUCK

Grid: B2/Landfill
 Comment:

Origin	Materials & Services	Quantity	Unit	Rate/Unit	Amount
0408/Camden City		26.85	Ton		

Driver: _____

Deputy Weighmaster: _____

Bonnie W

 Bonnie W. (29382)



①

CAPE MAY COUNTY MUA - LANDFILL
2050 COUNTY ROUTE 610
WOODBINE, NJ 08270
<http://www.cmcMua.com>

Facility ID: 0511C

Ticket: 50026053
Date: 3/23/2017
Time: 11:09:35 - 11:28:51

Truck: JD21
Customer: SW000257/BENEFICIAL SOIL SOI License: AL487L
Truck Type: DUMP TRUCK

Scale
Gross: 82060 LB In Scale IN
Tare: 26460 LB Out Scale OUT
Net: 55600 LB

Grid: B2/Landfill
Comment:

Origin	Materials & Services	Quantity	Unit	Rate/Unit	Amount
0408/Camden City		27.80	Ton		

Driver: Scott Moore
03/23/2017 11:28

Deputy Weighmaster: Bonnie W
03/23/2017 11:28
Bonnie W. (29382)



CAPE MAY COUNTY MUA - LANDFILL
 2050 COUNTY ROUTE 610
 WOODBINE, NJ 08270
<http://www.cmcMua.com>

Facility ID: 0511C

Ticket: 50025991
 Date: 3/23/2017
 Time: 08:33:28 - 08:54:48

Truck: JD25
 Customer: SW000257/BENEFICIAL SOIL SOI License: AS678M
 Carrier: SW000257/BENEFICIAL SOIL Truck Type: DUMP TRUCK

Scale
 Gross: 79220 LB In Scale IN
 Tare: 26900 LB Out Scale OUT
 Net: 52320 LB

Grid: B2/Landfill
 Comment:

Origin	Materials & Services	Quantity	Unit	Rate/Unit	Amount
0408/Camden City		26.16	Ton		

Driver: 

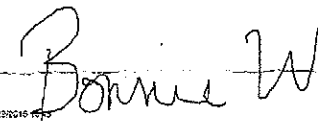
Deputy Weighmaster: 
 Bonnie W. (29382)

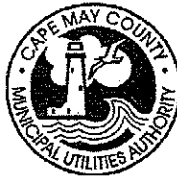

3

CAPE MAY COUNTY MUA - LANDFILL
2050 COUNTY ROUTE 610
WOODBINE, NJ 08270
<http://www.cmcmua.com>

Facility ID: 0511C

Ticket: 50026056
Date: 3/23/2017
Time: 11:15:41 - 11:32:54

Truck: JD25
Customer: SW000257/BENEFICIAL SOIL SOI License: AS678M
Carrier: SW000257/BENEFICIAL SOIL Truck Type: DUMP TRUCK

Scale
Gross: 81040 LB In Scale IN
Tare: 26680 LB Out Scale OUT
Net: 54360 LB

Grid: B2/Landfill
Comment:

Origin	Materials & Services	Quantity	Unit	Rate/Unit	Amount
0408/Camden City		27.18	Ton		

Driver: Ray Lopez
33032017 11:32

Deputy Weighmaster: Bonnie W
33032017 11:32
Bonnie W. (29382)

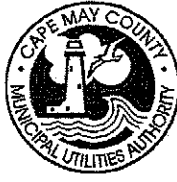

4

CAPE MAY COUNTY MUA - LANDFILL
2050 COUNTY ROUTE 610
WOODBINE, NJ 08270
<http://www.cmcMua.com>

Facility ID: 0511C

Ticket: 50026129
Date: 3/23/2017
Time: 14:13:50 - 14:31:06

Truck: JD21
Customer: SW000257/BENEFICIAL SOIL SOI License: AL487L
Truck Type: DUMP TRUCK

Scale
Gross: 79140 LB In Scale IN
Tare: 26260 LB Out Scale OUT
Net: 52880 LB

Grid: B2/Landfill
Comment:

Origin	Materials & Services	Quantity Unit	Rate/Unit	Amount
0408/Camden City		26.44 Ton		

Driver: 00252017 1431

Deputy Weighmaster: 50252015 1431
Bonnie W. (29382)

**APPENDIX C-2
HISTORIC FILL DISPOSAL
(SUBMITTED SEPARATELY)**



APPENDIX C-3
CONTAMINATED CONCRETE DISPOSAL



DATE 4-4-17

Inv

Superior Materials Inc.

149 Newbold Rd.
Fairless Hills, PA 19030
215-428-0503

Company Name Ambient Group

Job Location 324 N. FRONT ST

Truck # 21 CAMDEN NJ

Start Time 6:00

Lunch Time _____

Finish Time 3:30

Concrete Slabs 1111

Asphalt Millings _____

Asphalt/Dirt/Concrete _____

Earth/Subbase _____

Concrete Wash _____

Clean Fill _____

Total Loads 4



Authorization
M. [unclear]

DATE 4-6-17

Inv

Superior Materials Inc.

149 Newbold Rd.
Fairless Hills, PA 19030
215-428-0503

Company Name Ambicut Group

Job Location 324 No Front St.

Truck # 21 *CRANFORD NJ*

Start Time 6⁰⁰

Lunch Time _____

Finish Time 3³⁰

Concrete Slabs 1111

Asphalt Millings _____

Asphalt/Dirt/Concrete _____

Earth/Subbase _____

Concrete Wash _____

Clean Fill _____

Total Loads 4

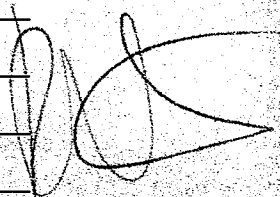

Authorization

**APPENDIX C-4
CONCRETE RECYCLING**



Phone: 609 267-4110



20 Maple Ave.
Lumberton, NJ 08048

№ 05820

Date: 3-23-17 Ticket# _____
Term Begins 3-24-17 Term Ends 3-30-17 Price for Term: \$320.00
(Price is subject to a LATE FEE of Ten Dollars (\$10) per day beyond the Term.)

Truck# _____ Driver: _____

15yd. <input type="checkbox"/>	Del: <input checked="" type="checkbox"/>	Concrete: <input checked="" type="checkbox"/>
20yd. <input checked="" type="checkbox"/>	Swap: <input type="checkbox"/>	Dirt: <input type="checkbox"/>
30yd. <input type="checkbox"/>	Final: <input type="checkbox"/>	Wood: <input type="checkbox"/>
40yd. <input type="checkbox"/>	DNR: <input type="checkbox"/>	Trash: <input type="checkbox"/>

Special Instructions: customer will be on-site until 3:30 to sign

Customer: Charles Tepson
856-419-4004

Company Name: The Ambient Group LLC

Billing Address: 222 Thies Road
Sewell NJ 08080

Ship To Address: 327 North Front Street
Camden NJ 08105

TERMS & CONDITIONS

THIS ORDER IS SUBJECT TO THE TERMS AND CONDITIONS SET FORTH BELOW AND ON THE REVERSE SIDE.

LOADING INSTRUCTIONS: Containers must not be loaded above the sides. Material that is loaded above the sides will be removed and left at the site. NO TOXIC, RADIOACTIVE, CORROSIVE, FLAMMABLE, FREON, TIRES, PAINT, MEDICAL OR INFECTIOUS WASTE OR HAZARDOUS MATERIALS (COLLECTIVELY: PROHIBITED MATERIALS) MAY BE LOADED INTO THE CONTAINER. CUSTOMER SHALL MAINTAIN TITLE TO AND LIABILITY FOR ALL PROHIBITED MATERIALS.

If these instructions are not followed, additional charges, including without limitation any fines or penalties assessed against Company, may be billed to Customer.

The undersigned is authorized to sign this Container Agreement on behalf of the Customer.

Customer Signature: [Signature] Print Name: _____

Phone: 609 267-4110



20 Maple Ave.
Lumberton, NJ 08048

№ 04964

Date: 3/24/17 Ticket# _____
Term Begins 3/27/17 Term Ends 4/2/17 Price for Term: \$32063
(Price is subject to a LATE FEE of Ten Dollars (\$10) per day beyond the Term.)

Truck# _____ Driver: _____

15yd.

Del:

Concrete:

20yd.

Swap:

Dirt:

30yd.

Final:

Wood:

40yd.

DNR:

Trash:

Special Instructions: customer will be on site to sign

Customer: Charles Iepson
956 419-0004

Company Name: Ambient Group

Billing Address: 222 Thies Road
Seaside NJ.

Ship To Address: 327 N. Front St.
(Camden NJ)

TERMS & CONDITIONS

THIS ORDER IS SUBJECT TO THE TERMS AND CONDITIONS SET FORTH BELOW AND ON THE REVERSE SIDE.

LOADING INSTRUCTIONS: Containers must not be loaded above the sides. Material that is loaded above the sides will be removed and left at the site. NO TOXIC, RADIOACTIVE, CORROSIVE, FLAMMABLE, FREON, TIRES, PAINT, MEDICAL OR INFECTIOUS WASTE OR HAZARDOUS MATERIALS (COLLECTIVELY :PROHIBITED MATERIALS) MAY BE LOADED INTO THE CONTAINER. CUSTOMER SHALL MAINTAIN TITLE TO AND LIABILITY FOR ALL PROHIBITED MATERIALS.

If these instructions are not followed, additional charges, including without limitation any fines or penalties assessed against Company, may be billed to Customer.

The undersigned is authorized to sign this Container Agreement on behalf of the Customer.

Customer Signature: [Signature] Print Name: Charles Iepson

Phone: 609 267-4110



20 Maple Ave.
Lumberton, NJ 08048

№ 05806

Date: 3-29-17 Ticket# _____

Term Begins: _____ Term Ends 3-30-17 Price for Term: _____
(Price is subject to a LATE FEE of Ten Dollars (\$10) per day beyond the Term.)

Truck# 217 Driver: _____

- | | | |
|---|--|---|
| 15yd. <input type="checkbox"/> | Del: <input type="checkbox"/> | Concrete: <input checked="" type="checkbox"/> |
| 20yd. <input checked="" type="checkbox"/> | Swap: <input type="checkbox"/> | Dirt: <input type="checkbox"/> |
| 30yd. <input type="checkbox"/> | Final: <input checked="" type="checkbox"/> | Wood: <input type="checkbox"/> |
| 40yd. <input type="checkbox"/> | DNR: <input type="checkbox"/> | Trash: <input type="checkbox"/> |

Special Instructions: customer will be on site until 3:30 on account customer

Customer: Charles Tepson
856-419-1004

Company Name: The Ambient Group LLC

Billing Address: 222 Tines Road
Sewell NJ 08080

Ship To Address: 327 North Front Street
Camden NJ 08105

TERMS & CONDITIONS

THIS ORDER IS SUBJECT TO THE TERMS AND CONDITIONS SET FORTH BELOW AND ON THE REVERSE SIDE.

LOADING INSTRUCTIONS: Containers must not be loaded above the sides. Material that is loaded above the sides will be removed and left at the site. NO TOXIC, RADIOACTIVE, CORROSIVE, FLAMMABLE, FREON, TIRES, PAINT, MEDICAL OR INFECTIOUS WASTE OR HAZARDOUS MATERIALS (COLLECTIVELY :PROHIBITED MATERIALS) MAY BE LOADED INTO THE CONTAINER. CUSTOMER SHALL MAINTAIN TITLE TO AND LIABILITY FOR ALL PROHIBITED MATERIALS.

If these instructions are not followed, additional charges, including without limitation any fines or penalties assessed against Company, may be billed to Customer.

The undersigned is authorized to sign this Container Agreement on behalf of the Customer.

Customer Signature: [Signature]

Print Name: _____

Phone: 609 267-4110



20 Maple Ave.
Lumberton, NJ 08048

№ 05807

Date: 3-29-17 Ticket# _____

Term Begins: _____ Term Ends 3-30-17 Price for Term: 207.19
(Price is subject to a LATE FEE of Ten Dollars (\$10) per day beyond the Term.)

Truck# _____ Driver: _____

15yd.

Del:

Concrete:

20yd.

Swap:

Dirt:

30yd.

Final:

Wood:

40yd.

DNR:

Trash:

Special Instructions: customer will be on site
until 3:30
off account customer

Customer: Charles Tapson
856-419-1004

Company Name: The Ambient
Group LLC

Billing Address:
222 Thies Road
Sewell NJ 08080

Ship To Address:
327 North Front Street
Candell NJ 08105

TERMS & CONDITIONS

THIS ORDER IS SUBJECT TO THE TERMS AND CONDITIONS SET FORTH BELOW AND ON THE REVERSE SIDE.

LOADING INSTRUCTIONS: Containers must not be loaded above the sides. Material that is loaded above the sides will be removed and left at the site. NO TOXIC, RADIOACTIVE, CORROSIVE, FLAMMABLE, FREON, TIRES, PAINT, MEDICAL OR INFECTIOUS WASTE OR HAZARDOUS MATERIALS (COLLECTIVELY :PROHIBITED MATERIALS) MAY BE LOADED INTO THE CONTAINER. CUSTOMER SHALL MAINTAIN TITLE TO AND LIABILITY FOR ALL PROHIBITED MATERIALS.

If these instructions are not followed, additional charges, including without limitation any fines or penalties assessed against Company, may be billed to Customer.

The undersigned is authorized to sign this Container Agreement on behalf of the Customer.

Customer Signature: _____ Print Name: _____

Phone: 609 267-4110



20 Maple Ave.
Lumberton, NJ 08048

№ 04983

Date: 4/3/17

Ticket#

Term Begins: _____ Term Ends 4/4/17 Price for Term: _____

(Price is subject to a LATE FEE of Ten Dollars (\$10) per day beyond the Term.)

Truck# _____ Driver: _____

15yd.

Del:

Concrete:

20yd.

Swap:

Dirt:

30yd.

Final:

Wood:

40yd.

DNR:

Trash:

Special Instructions:

Empty Can

Customer: JM Obeid

Company Name:

617-223-1096

Charter Contracting

Billing Address:

Ship To Address:

500 Hamson Ave
Boston MA

1101 S. Front St.
Camden NJ.

TERMS & CONDITIONS

THIS ORDER IS SUBJECT TO THE TERMS AND CONDITIONS SET FORTH BELOW AND ON THE REVERSE SIDE.

LOADING INSTRUCTIONS: Containers must not be loaded above the sides. Material that is loaded above the sides will be removed and left at the site. NO TOXIC, RADIOACTIVE, CORROSIVE, FLAMMABLE, FREON, TIRES, PAINT, MEDICAL OR INFECTIOUS WASTE OR HAZARDOUS MATERIALS (COLLECTIVELY PROHIBITED MATERIALS) MAY BE LOADED INTO THE CONTAINER. CUSTOMER SHALL MAINTAIN TITLE TO AND LIABILITY FOR ALL PROHIBITED MATERIALS.

If these instructions are not followed, additional charges, including without limitation any fines or penalties assessed against Company, may be billed to Customer.

The undersigned is authorized to sign this Container Agreement on behalf of the Customer.

Customer Signature:

Print Name:

Charles Egan

**APPENDIX D
CENTENNIAL AVENUE**



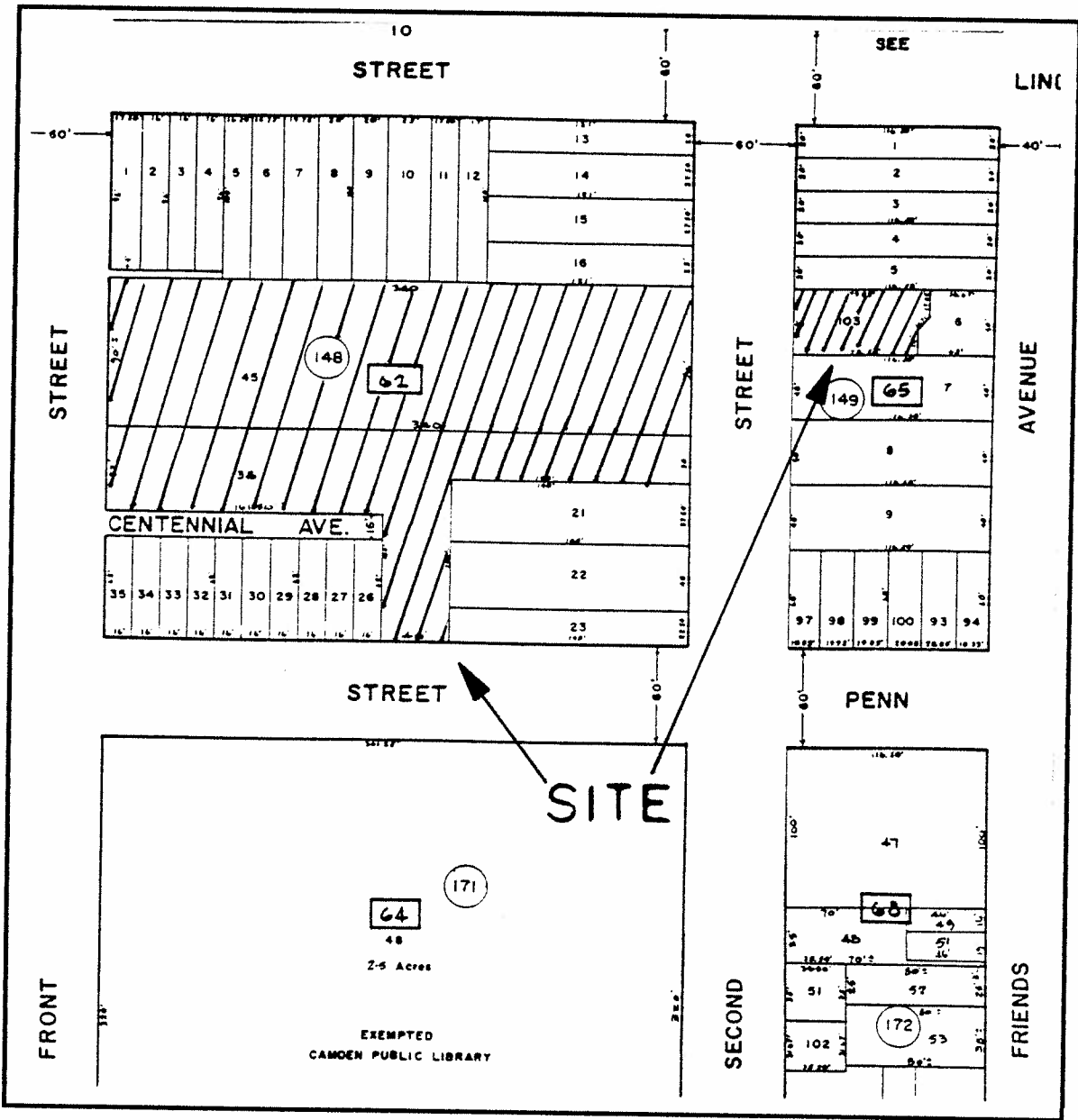

APPENDIX B

<p>CITY TAX MAP SHEETS #12 & 13 NOT TO SCALE</p>	<p>TAX MAP AABCO STEEL DRUM, INCORPORATED BLOCK 62, LOTS 38 & 45; BLOCK 65, LOT 103 CITY OF CAMDEN CAMDEN COUNTY</p>
--	--

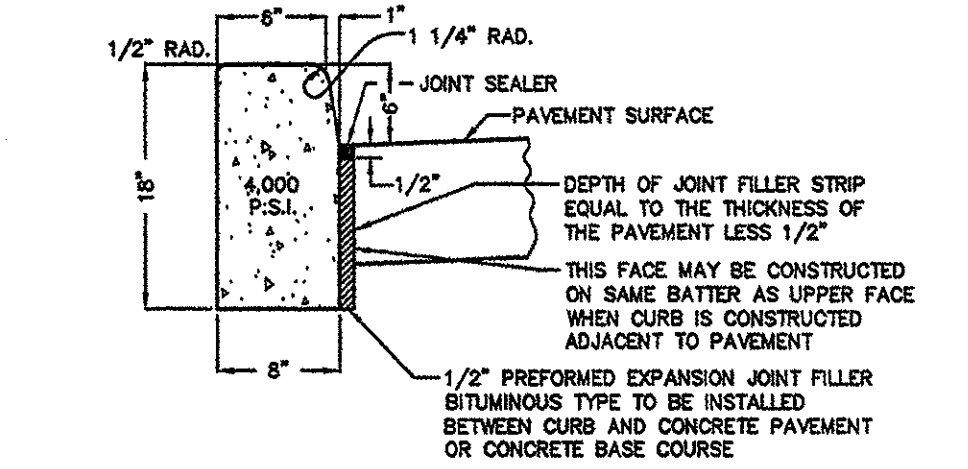

CITY CURB AND EXPANSION JOINT DETAIL
N.T.S.

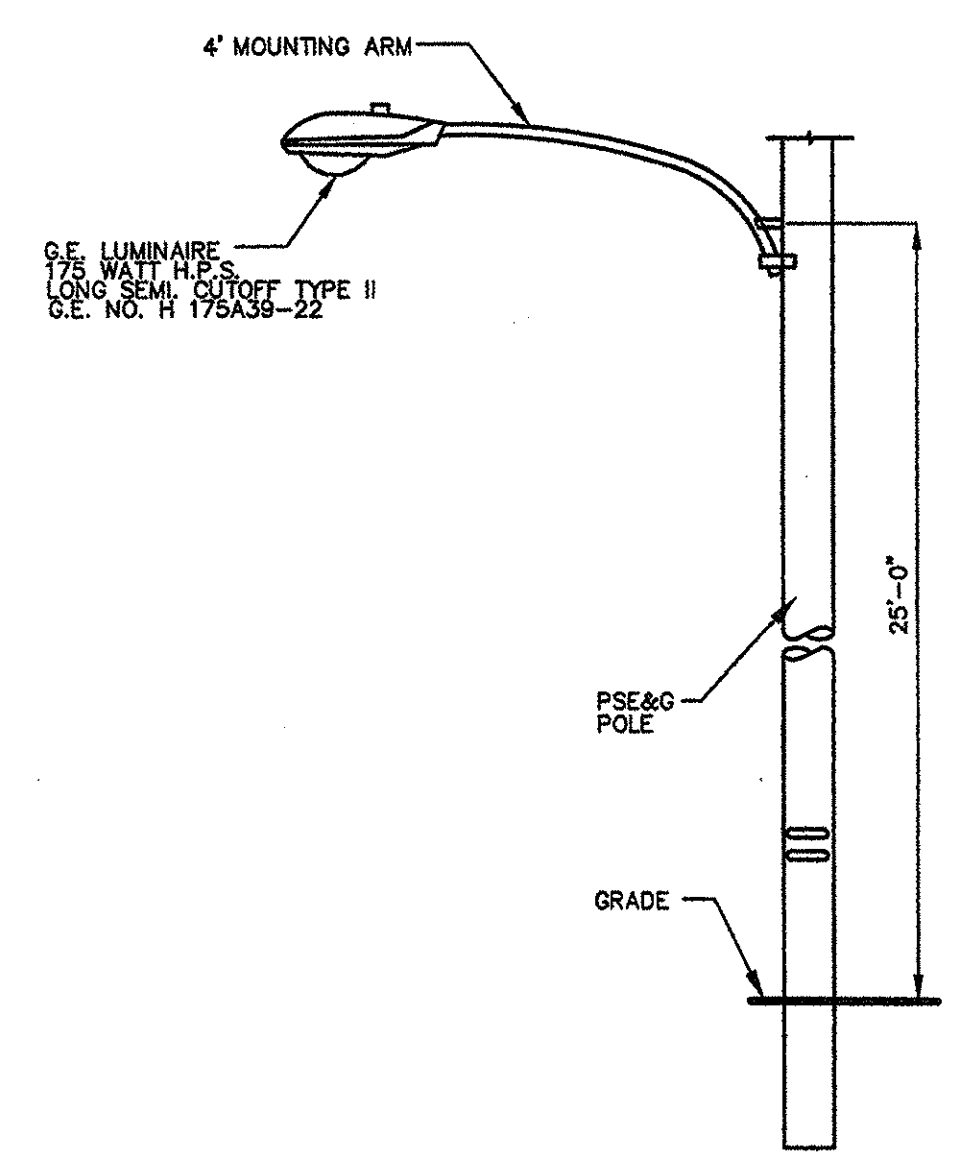

LIGHT DETAIL
N.T.S.

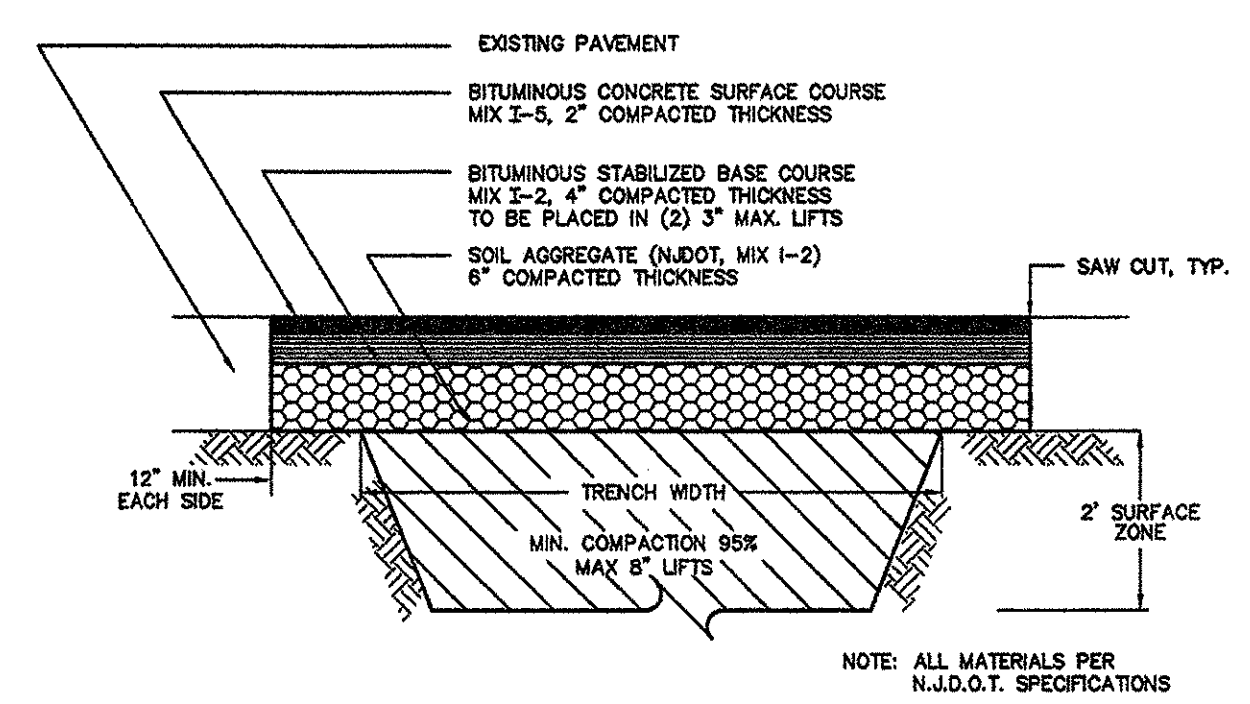

TRENCH & ROADWAY REPAIR DETAIL
N.T.S.

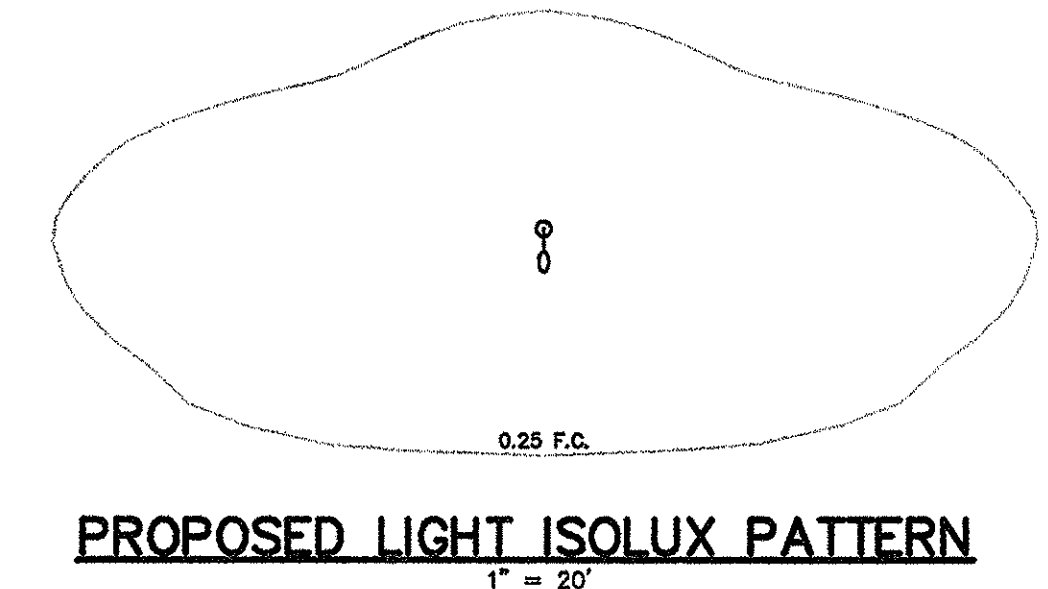

PROPOSED LIGHT ISOLUX PATTERN
1' x 20'

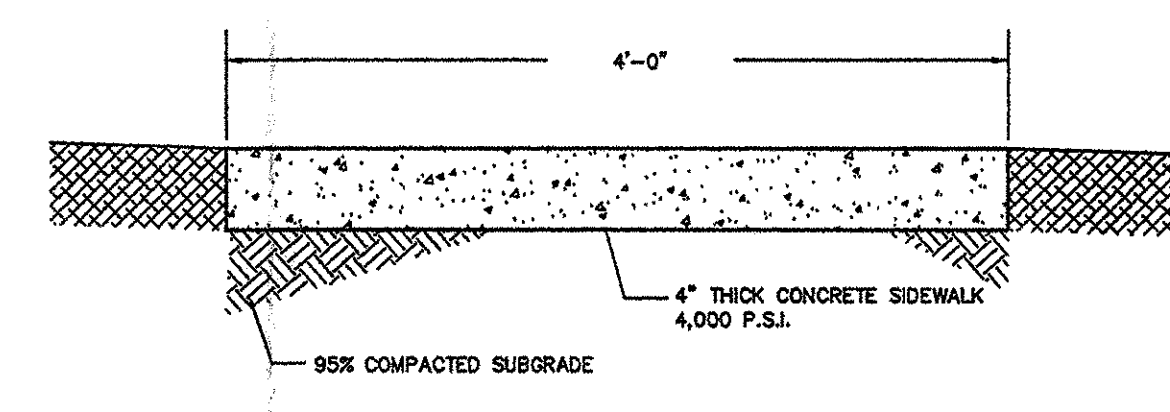

CONCRETE SIDEWALK DETAIL
N.T.S.

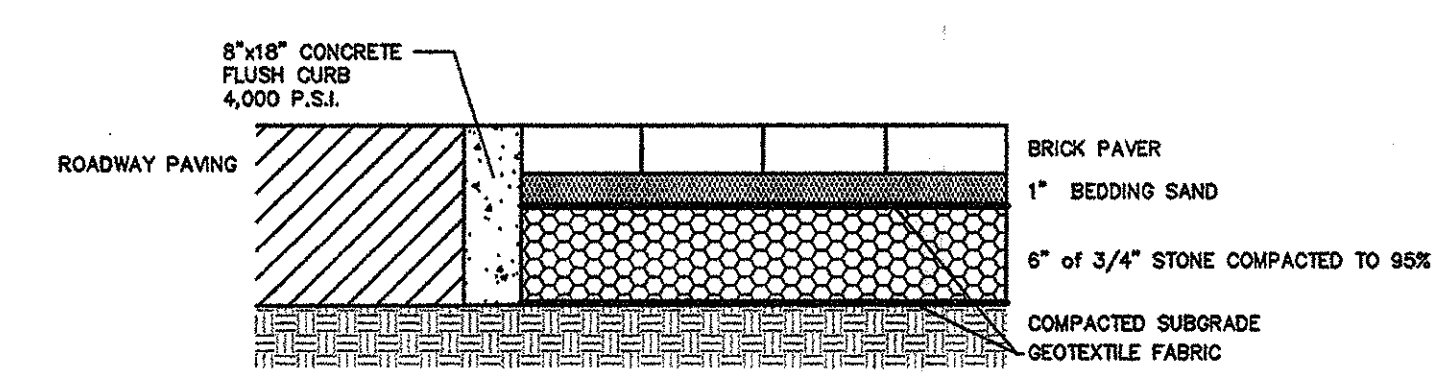

PAVER CROSS SECTION
N.T.S.

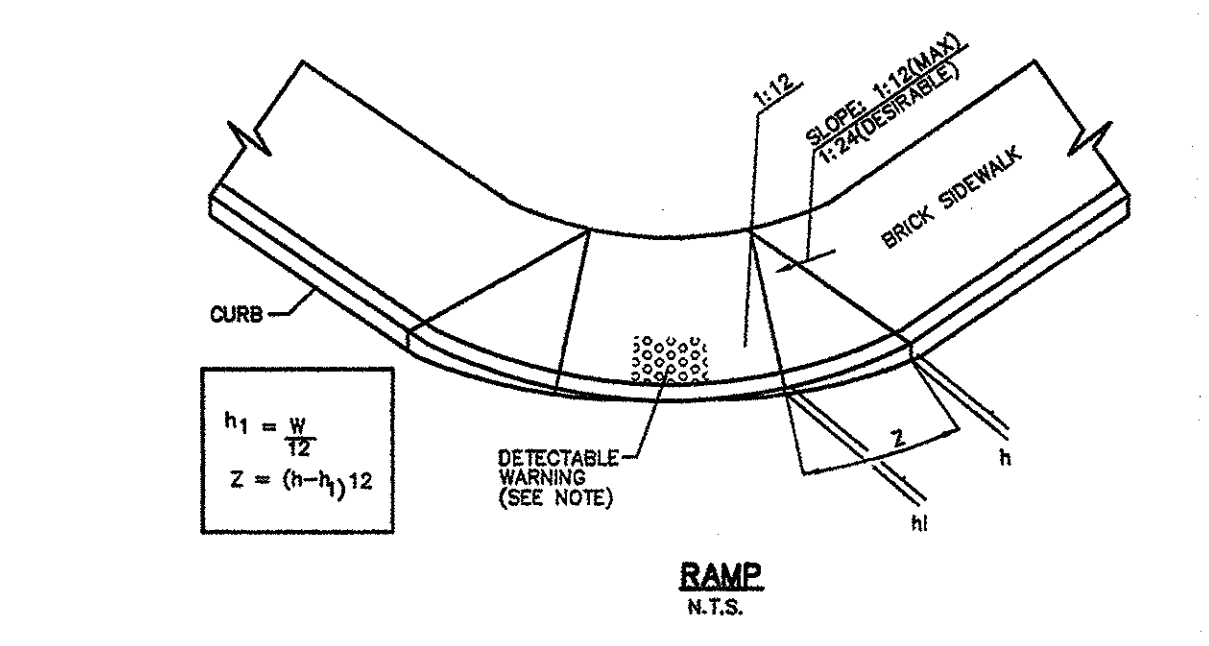

HANDICAPPED RAMP DETAILS
N.T.S.

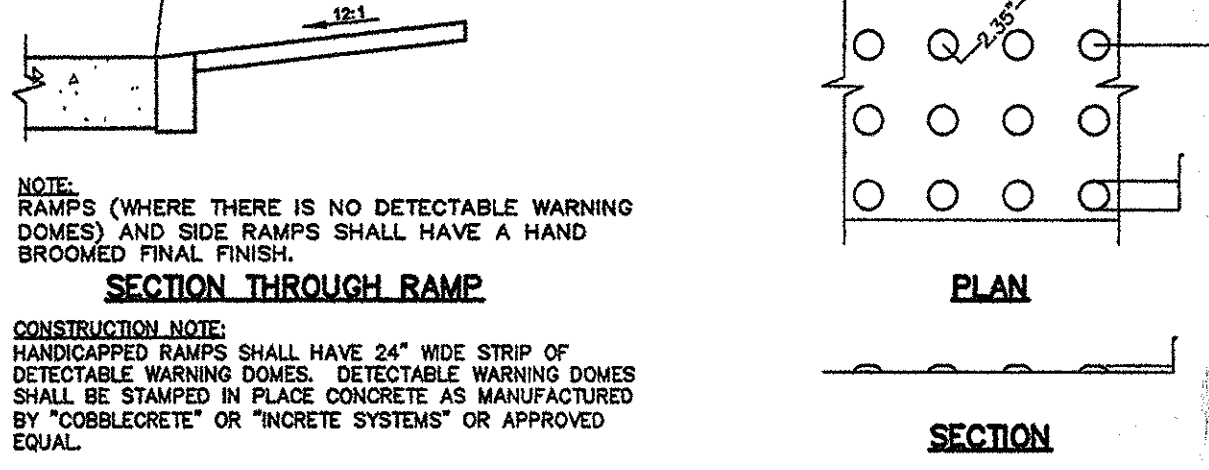

DETECTABLE WARNING DOMES
N.T.S.

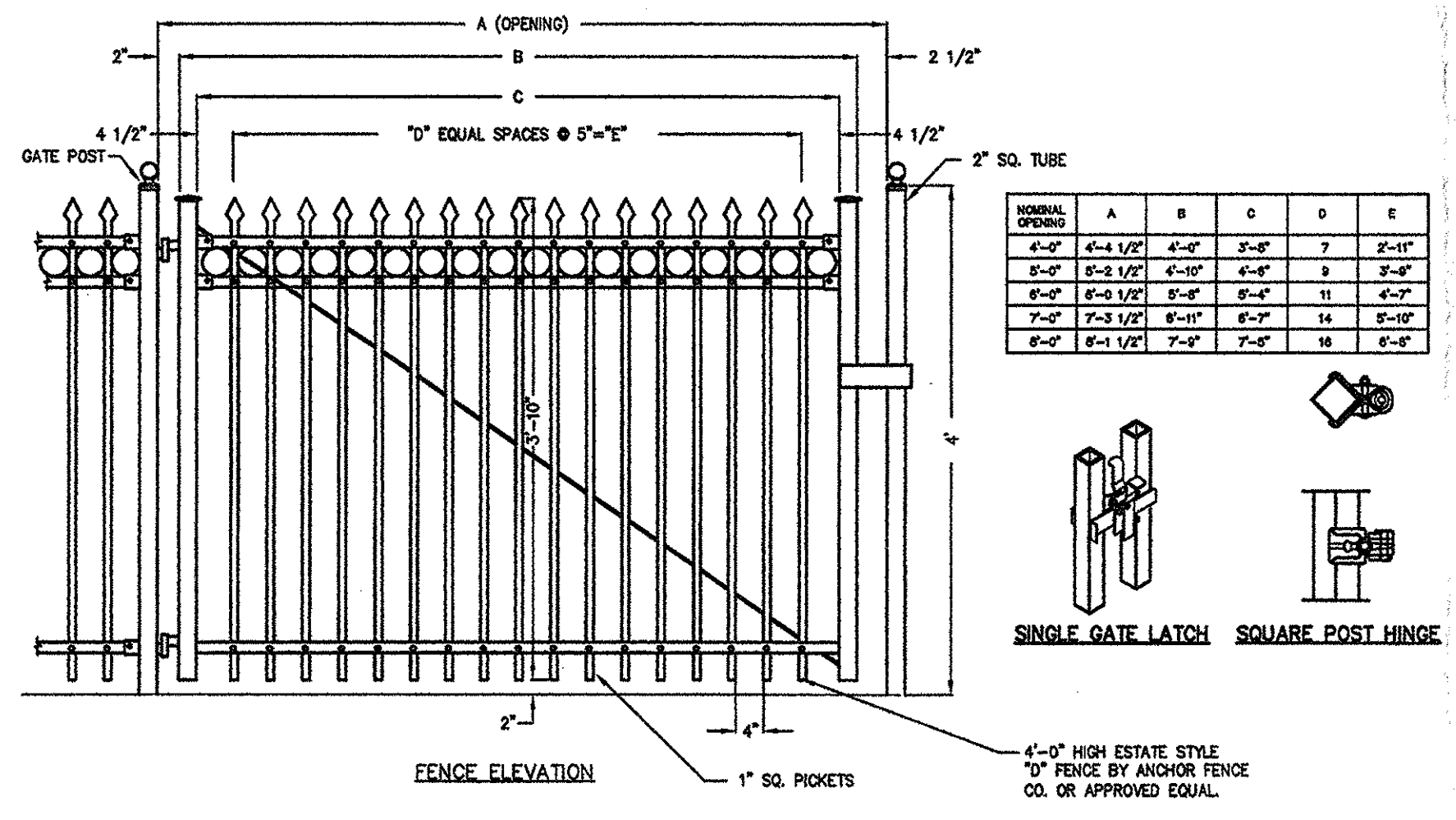

GATE DETAIL
N.T.S.

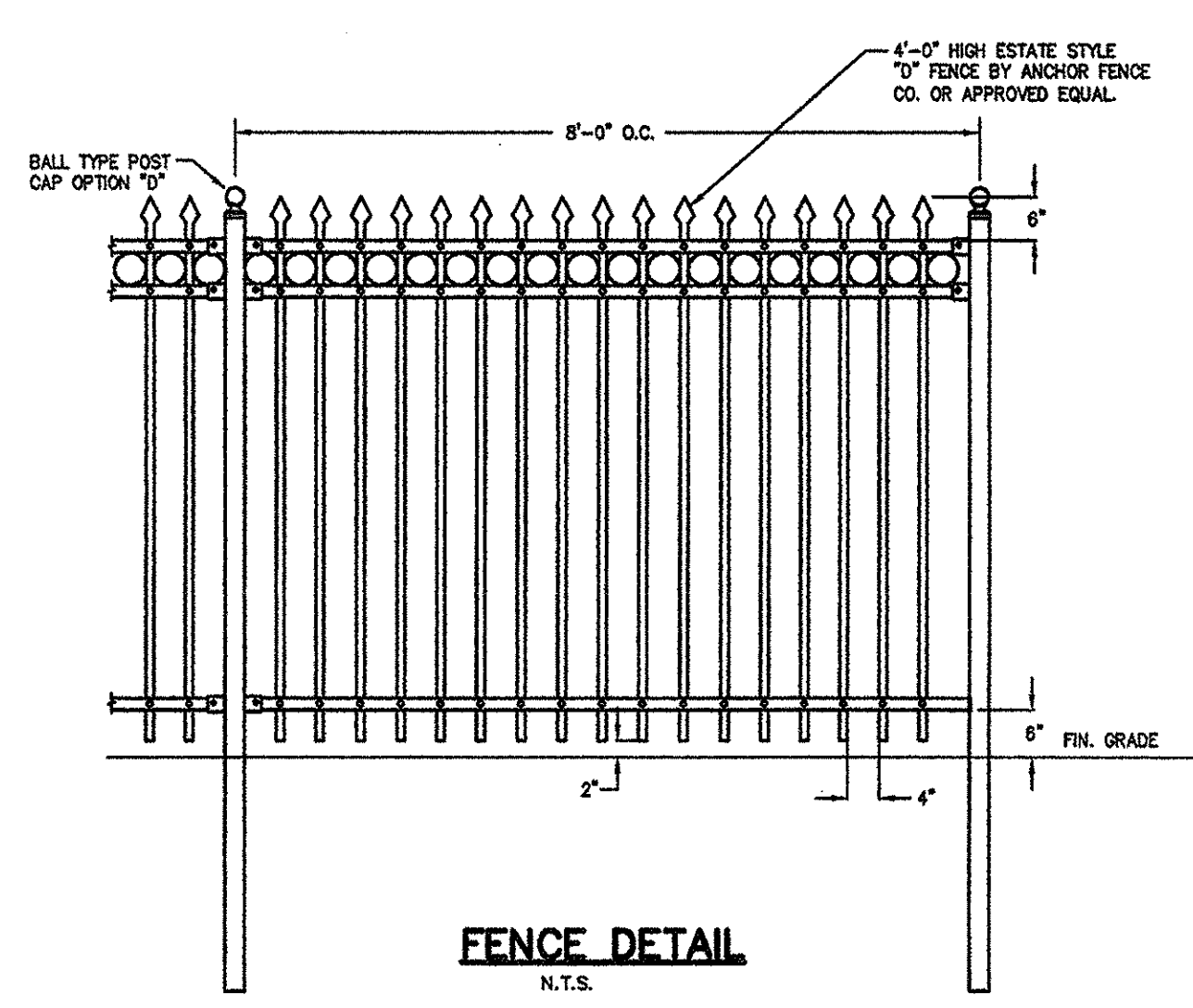

FENCE DETAIL
N.T.S.

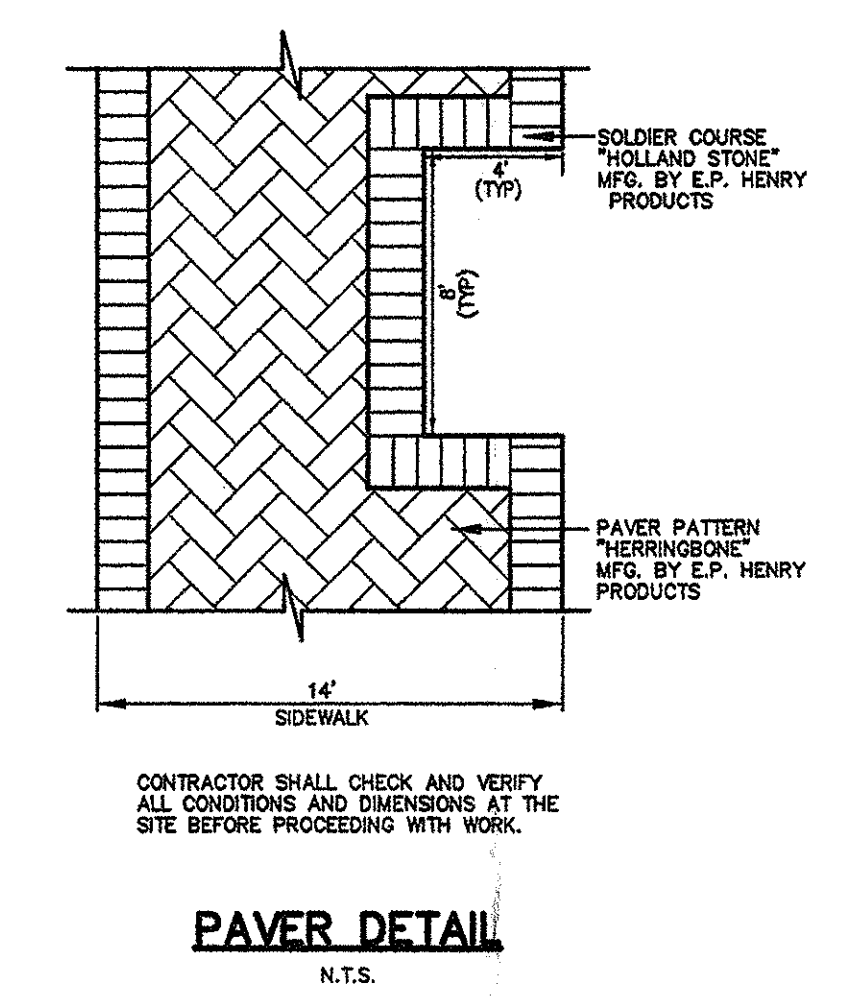

PAVER DETAIL
N.T.S.

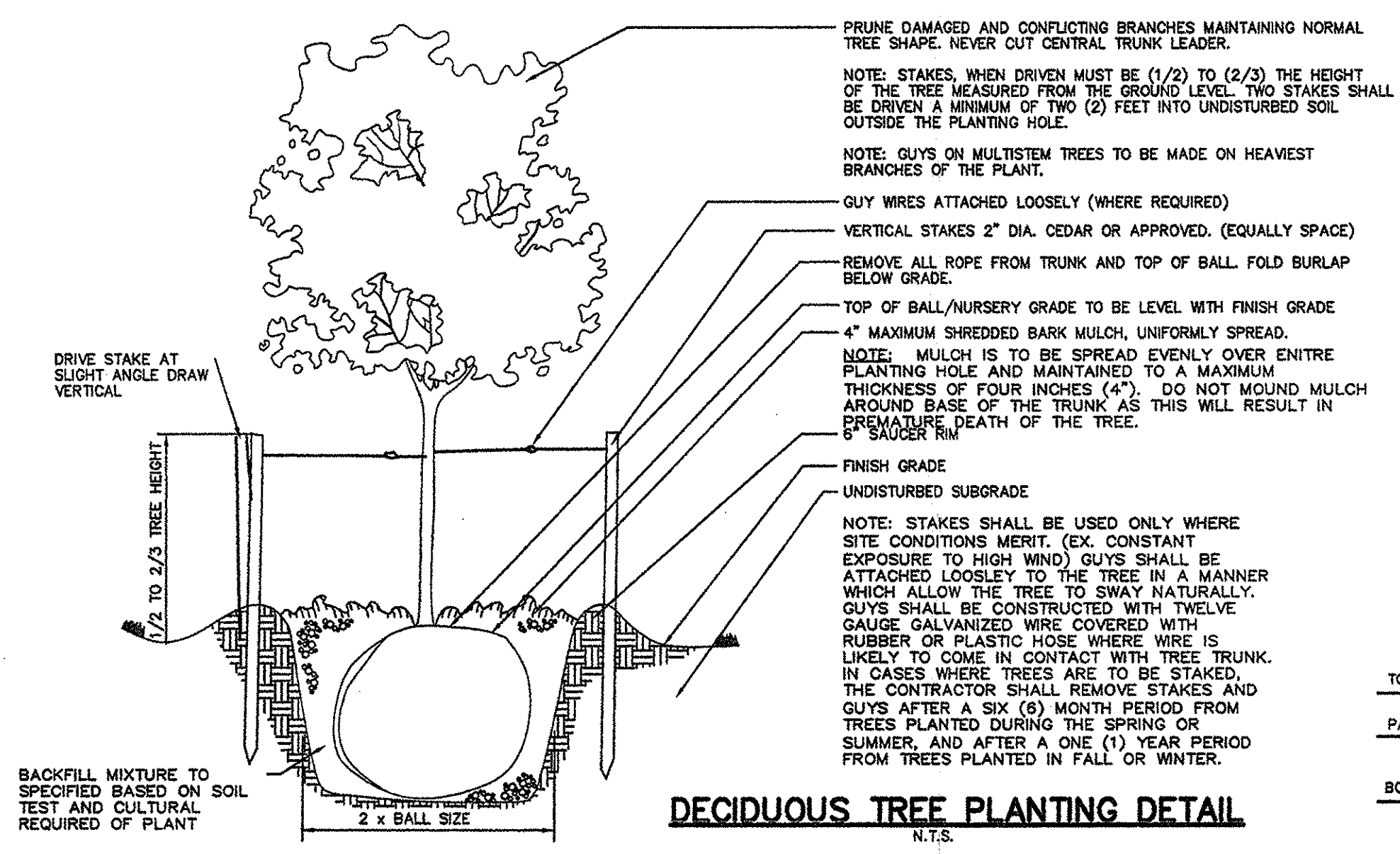

DECIDUOUS TREE PLANTING DETAIL
N.T.S.

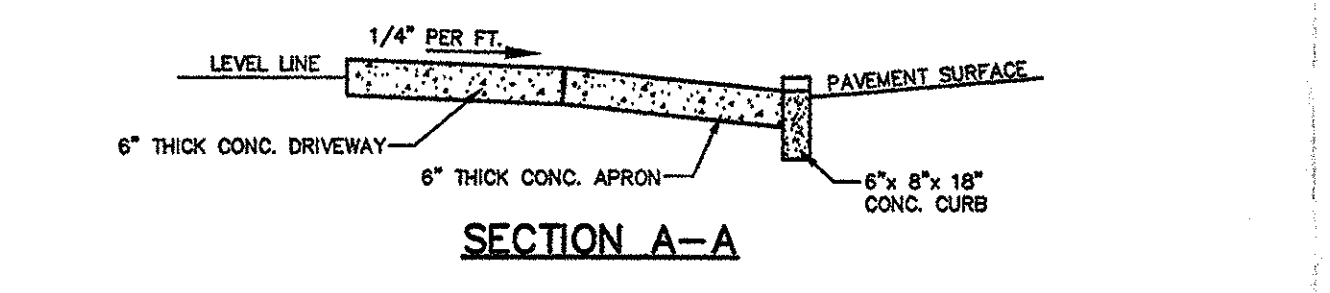

SECTION A-A

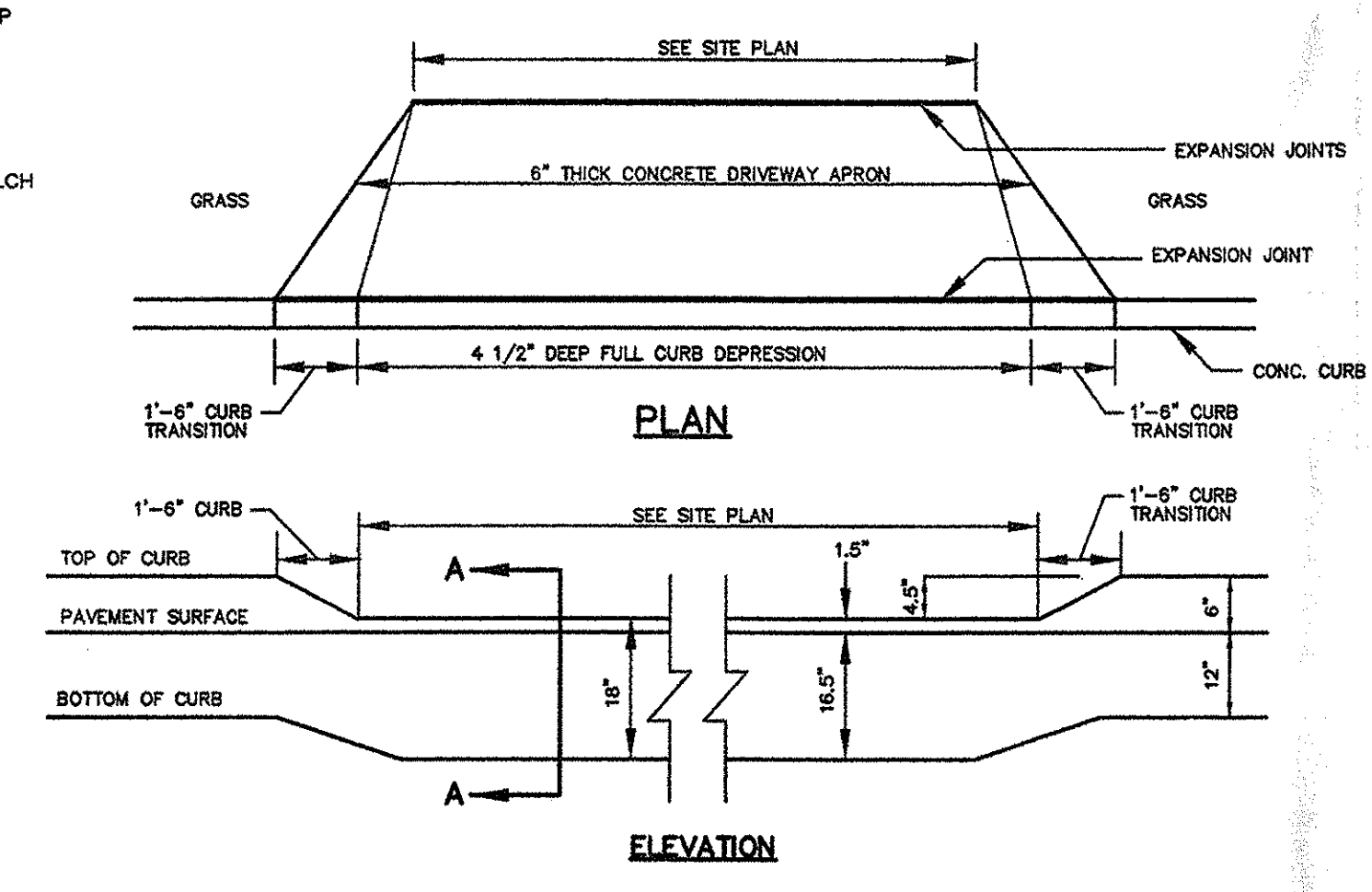

DRIVEWAY APRON & CURB DEPRESSION DETAIL
N.T.S.

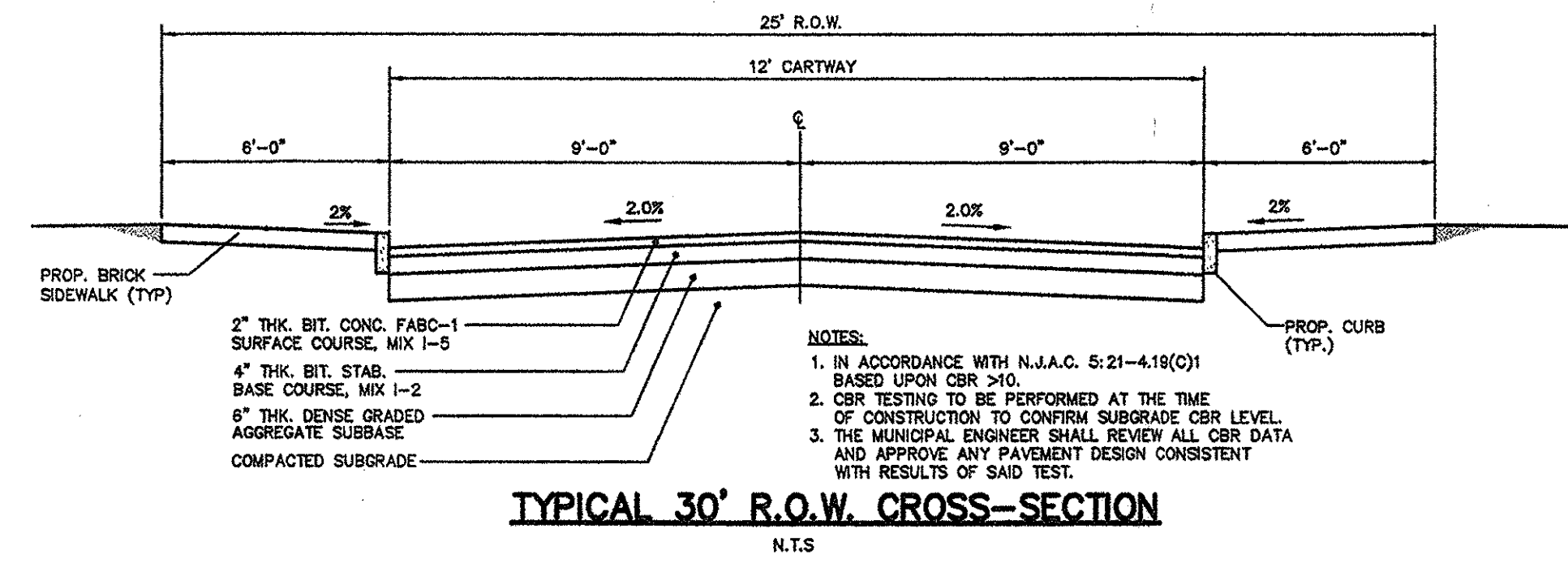

TYPICAL 30' R.O.W. CROSS-SECTION
N.T.S.

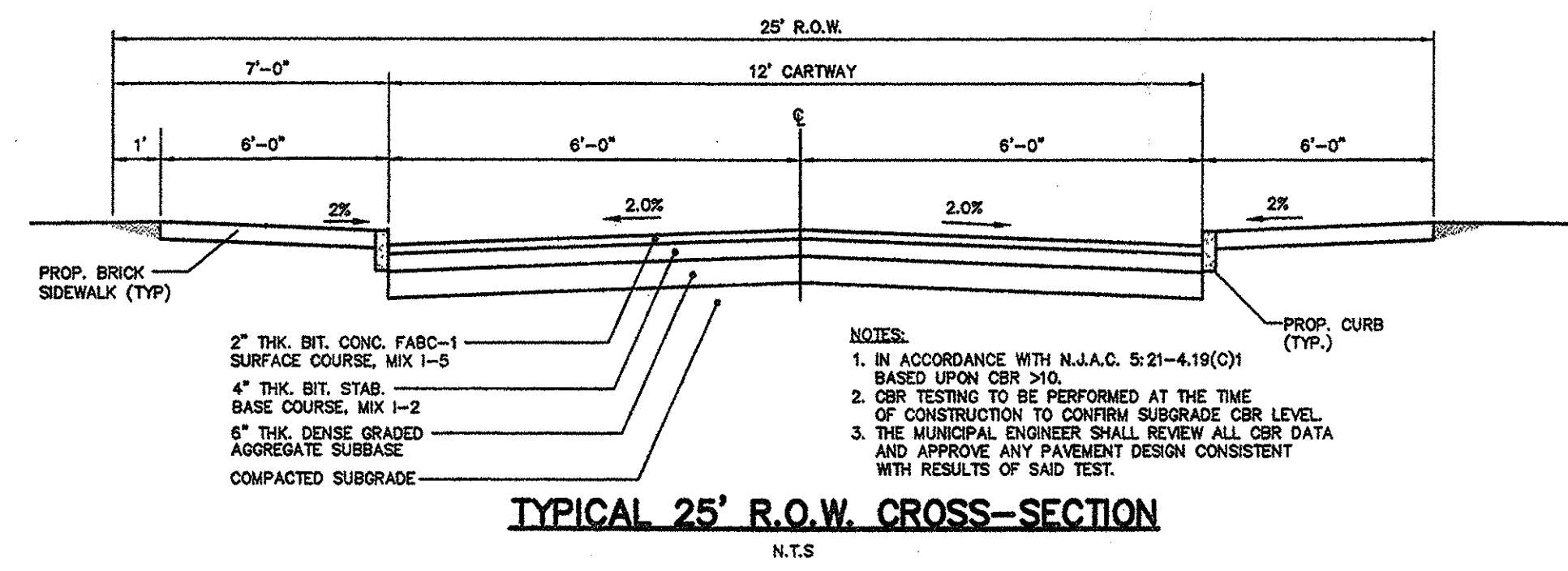

TYPICAL 25' R.O.W. CROSS-SECTION
N.T.S.

GENERAL NOTES:
1. ALL CONCRETE SHALL BE 4,000 PSI.

9/18/06
 DATE
 HENRY J. HALEY
 PROFESSIONAL ENGINEER, NEW JERSEY LIC. NO. 24098

REV	DATE	BY	DESCRIPTION
1	8/20/06	REV PER COORDINATION MEETING	
2	8/20/06	REV PER REVIEW ENGINEERS LETTERS	
3	8/20/06	REV PER REVIEW ENGINEERS LETTERS	
4	8/20/06	REV PER REVIEW ENGINEERS LETTERS	
5	8/20/06	REV PER REVIEW ENGINEERS LETTERS	
6	8/20/06	REV PER REVIEW ENGINEERS LETTERS	
7	8/20/06	REV PER REVIEW ENGINEERS LETTERS	
8	8/20/06	REV PER REVIEW ENGINEERS LETTERS	
9	8/20/06	REV PER REVIEW ENGINEERS LETTERS	
10	8/20/06	REV PER REVIEW ENGINEERS LETTERS	
11	8/20/06	REV PER REVIEW ENGINEERS LETTERS	
12	8/20/06	REV PER REVIEW ENGINEERS LETTERS	
13	8/20/06	REV PER REVIEW ENGINEERS LETTERS	
14	8/20/06	REV PER REVIEW ENGINEERS LETTERS	
15	8/20/06	REV PER REVIEW ENGINEERS LETTERS	
16	8/20/06	REV PER REVIEW ENGINEERS LETTERS	
17	8/20/06	REV PER REVIEW ENGINEERS LETTERS	
18	8/20/06	REV PER REVIEW ENGINEERS LETTERS	
19	8/20/06	REV PER REVIEW ENGINEERS LETTERS	
20	8/20/06	REV PER REVIEW ENGINEERS LETTERS	
21	8/20/06	REV PER REVIEW ENGINEERS LETTERS	
22	8/20/06	REV PER REVIEW ENGINEERS LETTERS	
23	8/20/06	REV PER REVIEW ENGINEERS LETTERS	
24	8/20/06	REV PER REVIEW ENGINEERS LETTERS	
25	8/20/06	REV PER REVIEW ENGINEERS LETTERS	
26	8/20/06	REV PER REVIEW ENGINEERS LETTERS	
27	8/20/06	REV PER REVIEW ENGINEERS LETTERS	
28	8/20/06	REV PER REVIEW ENGINEERS LETTERS	
29	8/20/06	REV PER REVIEW ENGINEERS LETTERS	
30	8/20/06	REV PER REVIEW ENGINEERS LETTERS	
31	8/20/06	REV PER REVIEW ENGINEERS LETTERS	
32	8/20/06	REV PER REVIEW ENGINEERS LETTERS	
33	8/20/06	REV PER REVIEW ENGINEERS LETTERS	
34	8/20/06	REV PER REVIEW ENGINEERS LETTERS	
35	8/20/06	REV PER REVIEW ENGINEERS LETTERS	
36	8/20/06	REV PER REVIEW ENGINEERS LETTERS	
37	8/20/06	REV PER REVIEW ENGINEERS LETTERS	
38	8/20/06	REV PER REVIEW ENGINEERS LETTERS	
39	8/20/06	REV PER REVIEW ENGINEERS LETTERS	
40	8/20/06	REV PER REVIEW ENGINEERS LETTERS	
41	8/20/06	REV PER REVIEW ENGINEERS LETTERS	
42	8/20/06	REV PER REVIEW ENGINEERS LETTERS	
43	8/20/06	REV PER REVIEW ENGINEERS LETTERS	
44	8/20/06	REV PER REVIEW ENGINEERS LETTERS	
45	8/20/06	REV PER REVIEW ENGINEERS LETTERS	
46	8/20/06	REV PER REVIEW ENGINEERS LETTERS	
47	8/20/06	REV PER REVIEW ENGINEERS LETTERS	
48	8/20/06	REV PER REVIEW ENGINEERS LETTERS	
49	8/20/06	REV PER REVIEW ENGINEERS LETTERS	
50	8/20/06	REV PER REVIEW ENGINEERS LETTERS	
51	8/20/06	REV PER REVIEW ENGINEERS LETTERS	
52	8/20/06	REV PER REVIEW ENGINEERS LETTERS	
53	8/20/06	REV PER REVIEW ENGINEERS LETTERS	
54	8/20/06	REV PER REVIEW ENGINEERS LETTERS	
55	8/20/06	REV PER REVIEW ENGINEERS LETTERS	
56	8/20/06	REV PER REVIEW ENGINEERS LETTERS	
57	8/20/06	REV PER REVIEW ENGINEERS LETTERS	
58	8/20/06	REV PER REVIEW ENGINEERS LETTERS	
59	8/20/06	REV PER REVIEW ENGINEERS LETTERS	
60	8/20/06	REV PER REVIEW ENGINEERS LETTERS	
61	8/20/06	REV PER REVIEW ENGINEERS LETTERS	
62	8/20/06	REV PER REVIEW ENGINEERS LETTERS	
63	8/20/06	REV PER REVIEW ENGINEERS LETTERS	
64	8/20/06	REV PER REVIEW ENGINEERS LETTERS	
65	8/20/06	REV PER REVIEW ENGINEERS LETTERS	
66	8/20/06	REV PER REVIEW ENGINEERS LETTERS	
67	8/20/06	REV PER REVIEW ENGINEERS LETTERS	
68	8/20/06	REV PER REVIEW ENGINEERS LETTERS	
69	8/20/06	REV PER REVIEW ENGINEERS LETTERS	
70	8/20/06	REV PER REVIEW ENGINEERS LETTERS	
71	8/20/06	REV PER REVIEW ENGINEERS LETTERS	
72	8/20/06	REV PER REVIEW ENGINEERS LETTERS	
73	8/20/06	REV PER REVIEW ENGINEERS LETTERS	
74	8/20/06	REV PER REVIEW ENGINEERS LETTERS	
75	8/20/06	REV PER REVIEW ENGINEERS LETTERS	
76	8/20/06	REV PER REVIEW ENGINEERS LETTERS	
77	8/20/06	REV PER REVIEW ENGINEERS LETTERS	
78	8/20/06	REV PER REVIEW ENGINEERS LETTERS	
79	8/20/06	REV PER REVIEW ENGINEERS LETTERS	
80	8/20/06	REV PER REVIEW ENGINEERS LETTERS	
81	8/20/06	REV PER REVIEW ENGINEERS LETTERS	
82	8/20/06	REV PER REVIEW ENGINEERS LETTERS	
83	8/20/06	REV PER REVIEW ENGINEERS LETTERS	
84	8/20/06	REV PER REVIEW ENGINEERS LETTERS	
85	8/20/06	REV PER REVIEW ENGINEERS LETTERS	
86	8/20/06	REV PER REVIEW ENGINEERS LETTERS	
87	8/20/06	REV PER REVIEW ENGINEERS LETTERS	
88	8/20/06	REV PER REVIEW ENGINEERS LETTERS	
89	8/20/06	REV PER REVIEW ENGINEERS LETTERS	
90	8/20/06	REV PER REVIEW ENGINEERS LETTERS	
91	8/20/06	REV PER REVIEW ENGINEERS LETTERS	
92	8/20/06	REV PER REVIEW ENGINEERS LETTERS	
93	8/20/06	REV PER REVIEW ENGINEERS LETTERS	
94	8/20/06	REV PER REVIEW ENGINEERS LETTERS	
95	8/20/06	REV PER REVIEW ENGINEERS LETTERS	
96	8/20/06	REV PER REVIEW ENGINEERS LETTERS	
97	8/20/06	REV PER REVIEW ENGINEERS LETTERS	
98	8/20/06	REV PER REVIEW ENGINEERS LETTERS	
99	8/20/06	REV PER REVIEW ENGINEERS LETTERS	
100	8/20/06	REV PER REVIEW ENGINEERS LETTERS	

PREPARED BY: SERVICES
 CONSULTING ENGINEER
 PROFESSIONAL ENGINEER, NEW JERSEY LIC. NO. 24098
 150 BELLAIR DRIVE, SUITE 100, SEWEL, NEW JERSEY 08080
 PHONE (609) 298-2200 - FAX (609) 292-2346
 N.J. CERTIFICATE OF AUTHORIZATION NO. GA276729

SHEET NO. 11 OF 15, DATE: 02/02/06, SCALE: N.T.S., CES No. 2008-02, FILE NO. 02/02/06, DRAWN BY: JH

P:\2006-2009\2006-02\0206-02\0206-02.dwg, Layout 1, 9/20/06 8:29:06 AM, gphases

**APPENDIX E
DEED NOTICE**





CAMDEN COUNTY, NJ
 CAMDEN COUNTY CLERK'S OFFICE
 D NOTICE M-OR BOOK 10850/831
 RECORDED 03/27/2018 09:38:56
 FILE NUMBER 2018021295
 RCPT #: 2012028; RECD BY: EF90
 RECORDING FEES \$11.00
 MARGINAL NOTATION \$0.00
 TOTAL TAX \$0.00



**Camden County
 Document Summary Sheet**

CAMDEN COUNTY CLERK 520 MARKET-ST CAMDEN NJ 08102	Return Name and Address
	Camden Redevelopment Agency 520 Market Street, Suite 1300 Camden, NJ 08102 Attn: James Harveson, Director of Economic Development

Official Use Only

Submitting Company	Camden Redevelopment Agency
Document Date (mm/dd/yyyy)	03/14/2018
Document Type	Deed Notice
No. of Pages of the Original Signed Document (Including the cover sheet)	27
Consideration Amount (If applicable)	\$0.00

First Party <i>(Grantor or Mortgagor or Assignor)</i> <i>(Enter up to five names)</i>	Name(s)	<i>(Last Name First Name Middle Initial Suffix)</i> <i>(or Company Name as written)</i>	Address (Optional)
	City of Camden Redevelopment Agency		520 Market Street, Suite 1300 Camden, NJ 08102

Second Party <i>(Grantee or Mortgagee or Assignee)</i> <i>(Enter up to five names)</i>	Name(s)	<i>(Last Name First Name Middle Initial Suffix)</i> <i>(or Company Name as written)</i>	Address (Optional)
	City of Camden Redevelopment Agency		520 Market Street Suite 1300 Camden, NJ 08102

Parcel Information <i>(Enter up to three entries)</i>	Municipality	Block	Lot	Qualifier	Property Address
	Camden	portion of former Block 02	38 & 45		Centennial Avenue

Reference Information <i>(Enter up to three entries)</i>	Book Type	Book	Beginning Page	Instrument No.	Recorded/File Date

***DO NOT REMOVE THIS PAGE.**
 DOCUMENT SUMMARY SHEET (COVER SHEET) IS PART OF CAMDEN COUNTY FILING RECORD. RETAIN THIS PAGE FOR FUTURE REFERENCE.

DEED NOTICE

IN ACCORDANCE WITH N.J.S.A. 58:10B-13, THIS DOCUMENT IS TO BE RECORDED IN THE SAME MANNER AS ARE DEEDS AND OTHER INTERESTS IN REAL PROPERTY.

Prepared by: _____
[Signature]

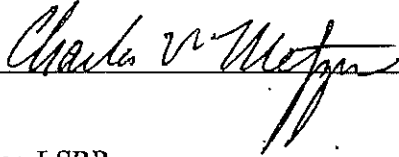

Charles V. Metzger, LSRP
[Print name below signature]

Recorded by: _____
[Signature, Officer of County Recording Office]

[Print name below signature]

DEED NOTICE

This Deed Notice is made as of the 14th day of March, 2018, by the City of Camden Redevelopment Agency, City Hall, Suite 1300, 520 Market Street, Camden, New Jersey, 08101 (together with his/her/its/their successors and assigns, collectively "Owner").

1. THE PROPERTY. City of Camden Redevelopment Agency, City Hall, Suite 1300, 520 Market Street, Camden, New Jersey, 08101 is the owner in fee simple of certain real property designated as Centennial Avenue Park, which occupies a portion of Former Block 62, Lots 38 and 45, on the tax map of the City of Camden of Camden County; the New Jersey Department of Environmental Protection Program Interest Number (Preferred ID) for the contaminated site which includes this property is PI#006594; and the property is more particularly described in Exhibit A, which is attached hereto and made a part hereof (the "Property").

2. REMEDIATION.

i. Charles V. Metzger, LSRP (License No. 668158) has approved this Deed Notice as an institutional control for the Property, which is part of the remediation of the Property.

ii. N.J.A.C. 7:26C-7 requires the Owner, among other persons, to obtain a soil remedial action permit for the soil remedial action at the Property. That permit will contain the monitoring, maintenance and biennial certification requirements that apply to the Property.

3. SOIL CONTAMINATION. City of Camden Redevelopment Agency has remediated contaminated soil at the Property, such that soil contamination remains in certain areas of the Property that contains contaminants in concentrations that do not allow for the unrestricted use of the Property; this soil contamination is described, including the type, concentration and specific location of such contaminants, in Exhibit B, which is attached hereto and made a part hereof. As a result, there is a statutory requirement for this Deed Notice and engineering controls in accordance with N.J.S.A. 58:10B-13.

4. CONSIDERATION. In accordance with the remedial action for the site which included the Property, and in consideration of the terms and conditions of that remedial action, and other good and valuable consideration, Owner has agreed to subject the Property to certain statutory and regulatory requirements that impose restrictions upon the use of the Property, to restrict certain uses of the Property, and to provide notice to subsequent owners, lessees and operators of the restrictions and the monitoring, maintenance, and biennial certification requirements outlined in this Deed Notice and required by law, as set forth herein.

5A. RESTRICTED AREAS. Due to the presence of contamination remaining at concentrations that do not allow for unrestricted use, the Owner has agreed, as part of the remedial action for the Property, to restrict the use of certain parts of the Property (the "Restricted Areas"); a narrative description of these restrictions is provided in Exhibit C, which is attached hereto and made a part hereof. The Owner has also agreed to maintain a list of these restrictions on site for inspection by governmental officials.

5B. RESTRICTED LAND USES. The following statutory land use restrictions apply to the Restricted Areas:

i. The Brownfield and Contaminated Site Remediation Act, N.J.S.A. 58:10B-12.g(10), prohibits the conversion of a contaminated site, remediated to non-residential soil remediation standards that require the maintenance of engineering or institutional controls, to a child care facility, or public, private, or charter school without the Department's prior written approval, unless a presumptive remedy is implemented; and

ii. The Brownfield and Contaminated Site Remediation Act, N.J.S.A. 58:10B-12.g(12), prohibits the conversion of a landfill, with gas venting systems and or leachate collection systems, to a single family residence or a child care facility without the Department's prior written approval.

5C. ENGINEERING CONTROLS. Due to the presence and concentration of these contaminants, the Owner has also agreed, as part of the remedial action for the Property, to the placement of certain engineering controls on the Property; a narrative description of these engineering controls is provided in Exhibit C.

6A. CHANGE IN OWNERSHIP AND REZONING.

i. The Owner and the subsequent owners and lessees, shall cause all leases, grants, and other written transfers of an interest in the Restricted Areas to contain a provision expressly

requiring all holders thereof to take the Property subject to the restrictions contained herein and to comply with all, and not to violate any of the conditions of this Deed Notice. Nothing contained in this Paragraph shall be construed as limiting any obligation of any person to provide any notice required by any law, regulation, or order of any governmental authority.

ii. The Owner and the subsequent owners shall provide written notice to the Department of Environmental Protection on a form provided by the Department and available at www.nj.gov/srp/forms within thirty (30) calendar days after the effective date of any conveyance, grant, gift, or other transfer, in whole or in part, of the owner's interest in the Restricted Area.

iii. The Owner and the subsequent owners shall provide written notice to the Department, on a form available from the Department at www.nj.gov/srp/forms, within thirty (30) calendar days after the owner's petition for or filing of any document initiating a rezoning of the Property to residential.

6B. SUCCESSORS AND ASSIGNS. This Deed Notice shall be binding upon Owner and upon Owner's successors and assigns, and subsequent owners, lessees and operators while each is an owner, lessee, or operator of the Property.

7A. ALTERATIONS, IMPROVEMENTS, AND DISTURBANCES.

i. The Owner and all subsequent owners and lessees shall notify any person, including, without limitation, tenants, employees of tenants, and contractors, intending to conduct invasive work or excavate within the Restricted Areas, of the nature and location of contamination in the Restricted Areas, and, of the precautions necessary to minimize potential human exposure to contaminants.

ii. Except as provided in Paragraph 7B, below, no person shall make, or allow to be made, any alteration, improvement, or disturbance in, to, or about the Property which disturbs any engineering control at the Property without first obtaining a soil remedial action permit modification pursuant to N.J.A.C. 7:26C-7. Nothing herein shall constitute a waiver of the obligation of any person to comply with all applicable laws and regulations including, without limitation, the applicable rules of the Occupational Safety and Health Administration.

iii. Notwithstanding subparagraph 7Aii., above, a soil remedial action permit modification is not required for any alteration, improvement, or disturbance provided that the owner, lessee or operator:

(A) Notifies the Department of Environmental Protection of the activity by calling the DEP Hotline, at 1-877-WARN-DEP or 1-877-927-6337, within twenty-four (24) hours after the beginning of each alteration, improvement, or disturbance;

(B) Restores any disturbance of an engineering control to pre-disturbance conditions within sixty (60) calendar days after the initiation of the alteration, improvement or disturbance;

(C) Ensures that all applicable worker health and safety laws and regulations are followed during the alteration, improvement, or disturbance, and during the restoration;

(D) Ensures that human exposure to contamination in excess of the remediation standards does not occur; and

(E) Describes, in the next biennial certification the nature of the alteration, improvement, or disturbance, the dates and duration of the alteration, improvement, or disturbance, the name of key individuals and their affiliations conducting the alteration, improvement, or disturbance, a description of the notice the Owner gave to those persons prior to the disturbance.

7B. EMERGENCIES. In the event of an emergency which presents, or may present, an unacceptable risk to the public health and safety, or to the environment, or immediate environmental concern, see N.J.S.A. 58:10C-2, any person may temporarily breach an engineering control provided that that person complies with each of the following:

i. Immediately notifies the Department of Environmental Protection of the emergency, by calling the DEP Hotline at 1-877-WARNDEP or 1-877-927-6337;

ii. Hires a Licensed Site Remediation Professional (unless the Restricted Areas includes an unregulated heating oil tank) to respond to the emergency;

iii. Limits both the actual disturbance and the time needed for the disturbance to the minimum reasonably necessary to adequately respond to the emergency;

iv. Implements all measures necessary to limit actual or potential, present or future risk of exposure to humans or the environment to the contamination;

v. Notifies the Department of Environmental Protection when the emergency or immediate environmental concern has ended by calling the DEP Hotline at 1-877-WARNDEP or 1-877-927-6337; and

vi. Restores the engineering control to the pre-emergency conditions as soon as possible, and provides notification to the Department of Environmental Protection within sixty (60) calendar days after completion of the restoration of the engineering control, including: (a) the nature and likely cause of the emergency; (b) the potential discharges of or exposures to contaminants, if any, that may have occurred; (c) the measures that have been taken to mitigate the effects of the emergency on human health and the environment; (d) the measures completed or implemented to restore the engineering control; and (e) the changes to the engineering control or site operation and maintenance plan to prevent reoccurrence of such conditions in the future.

8. TERMINATION OF DEED NOTICE.

i. This Deed Notice may be terminated only upon filing of a Termination of Deed Notice, available at N.J.A.C. 7:26C Appendix C, with the office of the County Clerk of Camden County, New Jersey, expressly terminating this Deed Notice.

ii. Within thirty (30) calendar days after the filing of a Termination of Deed Notice, the owner of the property shall apply to the Department for termination of the soil remedial action permit pursuant to N.J.A.C. 7:26C-7.

9. ACCESS. The Owner, and the subsequent owners, lessees and operators agree to allow the Department, its agents and representatives access to the Property to inspect and evaluate the continued protectiveness of the remedial action that includes this Deed Notice and to conduct additional remediation to ensure the protection of the public health and safety and of the environment if the subsequent owners, lessees and operators, during their ownership, tenancy, or operation, and the Owner fail to conduct such remediation pursuant to this Deed Notice as required by law. The Owner, and the subsequent owners and lessees, shall also cause all leases, subleases, grants, and other written transfers of an interest in the Restricted Areas to contain a provision expressly requiring that all holders thereof provide such access to the Department.

10. ENFORCEMENT OF VIOLATIONS.

i. This Deed Notice itself is not intended to create any interest in real estate in favor of the Department of Environmental Protection, nor to create a lien against the Property, but merely is intended to provide notice of certain conditions and restrictions on the Property and to reflect the regulatory and statutory obligations imposed as a conditional remedial action for this site.

ii. The restrictions provided herein may be enforceable solely by the Department against any person who violates this Deed Notice. To enforce violations of this Deed Notice, the Department may initiate one or more enforcement actions pursuant to N.J.S.A. 58:10-23.11, and N.J.S.A. 58:10C, and require additional remediation and assess damages pursuant to N.J.S.A. 58:10-23.11, and N.J.S.A. 58:10C.

11. SEVERABILITY. If any court of competent jurisdiction determines that any provision of this Deed Notice requires modification, such provision shall be deemed to have been modified automatically to conform to such requirements. If a court of competent jurisdiction determines that any provision of this Deed Notice is invalid or unenforceable and the provision is of such a nature that it cannot be modified, the provision shall be deemed deleted from this instrument as though the provision had never been included herein. In either case, the remaining provisions of this Deed Notice shall remain in full force and effect.

12A. EXHIBIT A. Exhibit A includes the following maps of the Property and the vicinity:

i. Exhibit A-1: Vicinity Map - A map that identifies by name the roads, and other important geographical features in the vicinity of the Property (for example, USGS Quad map, Hagstrom County Maps);

ii. Exhibit A-2: Metes and Bounds Description - A tax map of lots and blocks as wells as metes and bounds description of the Property, including reference to tax lot and block numbers for the Property, if applicable;

iii. Exhibit A-3: Property Map - A scaled map of the Property, scaled at one inch to 200 feet or less, and if more than one map is submitted, the maps shall be presented as overlays, keyed to a base map; and the Property Map shall include diagrams of major surface topographical features such as buildings, roads, and parking lots.

12B. EXHIBIT B. Exhibit B includes the following descriptions of the Restricted Areas:

i. Exhibit B-1: Restricted Area Map - A separate map for each restricted area that includes:

(A) As-built diagrams of each engineering control, including caps, fences, slurry walls, (and, if any) ground water monitoring wells, extent of the ground water classification exception area, pumping and treatment systems that may be required as part of a ground water engineering control in addition to the deed notice

(B) As-built diagrams of any buildings, roads, parking lots and other structures that function as engineering controls; and

(C) Designation of all soil and sediment sample locations within the restricted areas that exceed any soil or sediment standard that are keyed into one of the tables described in the following paragraph.

ii. Exhibit B-2: Restricted Area Data Table - A separate table for each restricted area that includes either (A) or (B) through (F):

(A) Only for historic fill extending over the entire site or a portion of the site and for which analytical data are limited or do not exist, a narrative that states that historic fill is present at the site, a description of the fill material (e.g., ash, cinders, brick, dredge material), and a statement that such material may include, but is not limited to, contaminants such as PAHs and metals;

(B) Sample location designation from Restricted Area map (Exhibit B-1);

(C) Sample elevation based upon mean sea level;

(D) Name and chemical abstract service registry number of each contaminant with a concentration that exceeds the unrestricted use standard;

(E) The restricted and unrestricted use standards for each contaminant in the table; and

(F) The remaining concentration of each contaminant at each sample location at each elevation.

12C. EXHIBIT C. Exhibit C includes narrative descriptions of the institutional controls and engineering controls as follows:

i. Exhibit C-1: Deed Notice as Institutional Control: Exhibit C-1 includes a narrative description of the restriction and obligations of this Deed Notice that are in addition to those described above, as follows:

(A) Description and estimated size of the Restricted Areas as described above;

(B) Description of the restrictions on the Property by operation of this Deed Notice; and

(C) The objective of the restrictions.

ii. Exhibit C-2: Engineered Cap. Exhibit C-2 includes a narrative description of the engineered cap, as follows:

(A) Description of the engineering control;

(B) The objective of the engineering control; and

(C) How the engineering control is intended to function.

14. SIGNATURES. IN WITNESS WHEREOF, Owner has executed this Deed Notice as of the date first written above.

ATTEST:

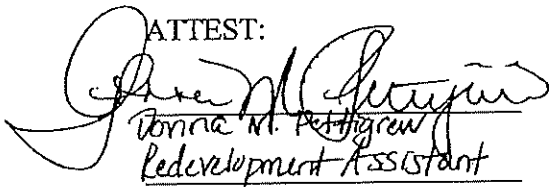
Jonna M. Pettigrew
Redevelopment Assistant

[Print name and title]

City of Camden Redevelopment Agency

By

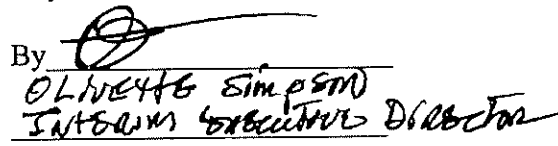

OLIVETTE SIMPSON
INTERIM EXECUTIVE DIRECTOR

[Signature]

STATE OF NEW JERSEY SS.:
COUNTY OF CAMDEN

I certify that on March 14, 2018, Olivette Simpson personally came before me, and this person acknowledged under oath, to my satisfaction, that:

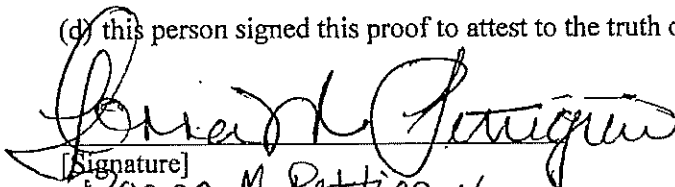
- (a) this person is the Interim Executive Director of the City of Camden Redevelopment Agency, the municipal agency named in this document;
- (b) this person is the attesting witness to the signing of this document by the proper officer who is the Interim Executive Director of the municipal agency;
- (c) this document was signed and delivered by the municipal agency as its voluntary act and was duly authorized; and
- (d) this person signed this proof to attest to the truth of these facts.

[Signature]
Donna M. Pettigrew
Notary Public
[Print name and title of attesting witness]

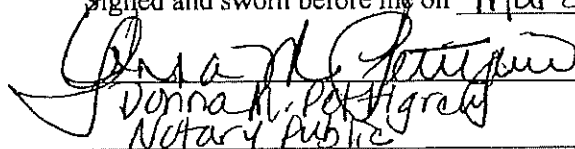
Signed and sworn before me on March 14, 2018
, Notary Public
Donna M. Pettigrew
Notary Public
[Print name and title]

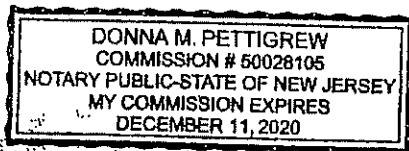
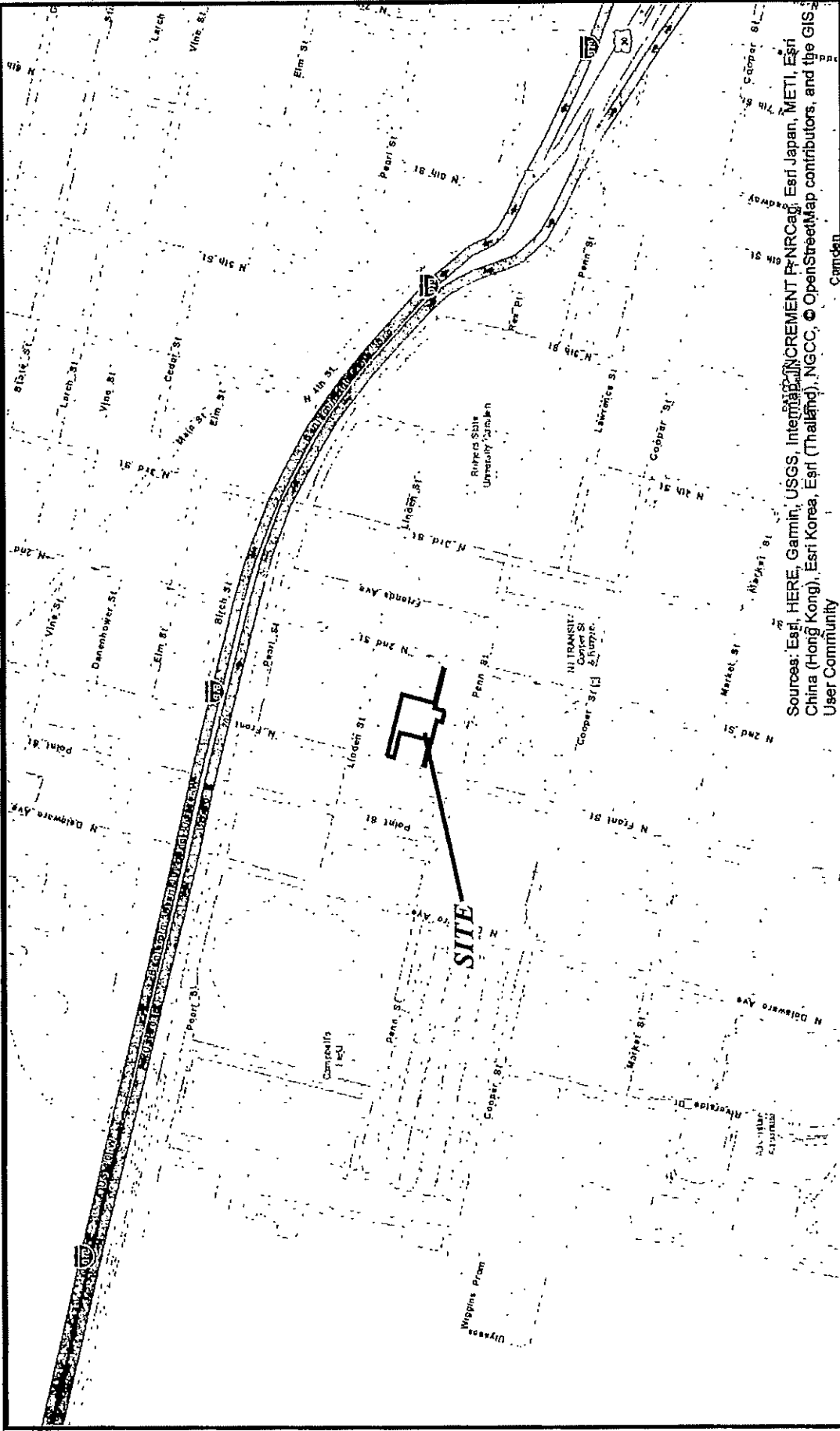

Exhibit A-1



Sources: Esri, HERE, DeLorme, USGS, Intermap, INCREMENT P, NRCA, Esri Japan, METI, Esri
 China (Hong Kong), Esri Korea, Esri (Thailand), NGCC, © OpenStreetMap contributors, and the GIS
 User Community

EXHIBIT A-1: VICINITY MAP

Site Boundary



PROJECT NAME: ABC BARREL COMPANY/CENTENNIAL AVE
 PROJECT ADDRESS: 308-322 NORTH FRONT STREET, CAMDEN, NJ
 NJDEP SRP PI#: 006594

DATE: FEBRUARY 2018

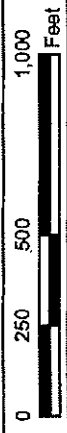

Exhibit A-2

ATTENTION:

The point of beginning in the Metes and Bounds description
(dated June 1, 2017) references Lot 20, Block 62.

Please note that Lot 20, Block 62 references the Plan of Site Lot
and Block designation.

The current Tax Assessor's Lot and Block designation for that
parcel is Lot 23, Block 62.



consulting engineer services

Engineers, Planners, and Land Surveyors

June 1, 2017

DESCRIPTION
RESTRICTED RAO AREA
ACROSS CENTENNIAL AVENUE

LAND SITUATE
CITY OF CAMDEN, CAMDEN COUNTY, NEW JERSEY

BEGINNING at a point in the Westerly right-of-way line of Second Street (60' Wide), said point being the southeasterly corner of Lot 20, Block 62, common with the northerly line of Centennial Avenue and said point being located the following described One (1) course from a point formed by the intersection of the Westerly right-of-way line of Second Street with the Northerly right-of-way line of Penn Street (60' Wide), as is shown on the hereinafter described plan, and extending; Thence

- a) Along the Westerly right-of-way line of Second Street, North 15 Degrees 55 Minutes 05 Seconds East, a distance of 99.47 Feet; to the point of beginning and extending from said beginning point; Thence
- 1) North 75 Degrees 33 Minutes 03 Seconds West, a distance of 121.00 Feet to a point; Thence
 - 2) North 14 Degrees 27 Minutes 02 Seconds East, a distance of 115.50 Feet to a point; Thence
 - 3) North 75 Degrees 33 Minutes 03 Seconds West, a distance of 220.41 Feet to a point; Thence
 - 4) South 14 Degrees 27 Minutes 37 Seconds West, a distance of 25.00 Feet to a point; Thence
 - 5) South 75 Degrees 33 Minutes 03 Seconds East, a distance of 90.00 Feet to a point; Thence
 - 6) South 14 Degrees 27 Minutes 37 Seconds West, a distance of 107.84 Feet to a point; Thence
 - 7) North 75 Degrees 31 Minutes 13 Seconds West, a distance of 90.00 Feet to a point; Thence
 - 8) South 14 Degrees 27 Minutes 37 Seconds West, a distance of 5.00 Feet to a point; Thence
 - 9) South 75 Degrees 31 Minutes 13 Seconds East, a distance of 161.43 Feet to a point; Thence
 - 10) South 14 Degrees 27 Minutes 02 Seconds West, a distance of 20.00 Feet to a point; Thence
 - 11) South 75 Degrees 31 Minutes 13 Seconds East, a distance of 18.97 Feet to a point of curvature; Thence

645 Berlin-Cross Keys Road, Suite 1, Sicklerville, N.J. 08081
856-228-2200 Fax 856-232-2346 design@ces-1.com
NJ Certificate of Authorization #24GA27857700

P:\Projects\3582\1reports\legals\RestrictedArea.doc

- 12) Along a curve, curving to the left, having a radius of 41.00 Feet, an arc length of 22.08 Feet, an interior angle of 30 Degrees 51 Minutes 22 Seconds and having a chord bearing of North 89 Degrees 01 Minutes 16 Seconds East with a chord length of 21.81 Feet to a point; Thence
- 13) North 14 Degrees 27 Minutes 02 Seconds East, a distance of 31.58 Feet to a point; Thence
- 14) South 75 Degrees 33 Minutes 03 Seconds East, a distance of 140.00 Feet to a point; Thence
- 15) North 14 Degrees 27 Minutes 06 Seconds East, a distance of 5.00 Feet to a point and place of BEGINNING.

Herein above described lands being a portion of Centennial Avenue as shown on containing 21,715 Square Feet, is graphically shown on the plan entitled: RESTRICTED AREA EXHIBIT, City of Camden, Camden County, New Jersey, as was prepared by Consulting Engineer Services, last revised 06/01/2017.

Adam R. Grant
Professional Land Surveyor
New Jersey License No. 24GS04335700

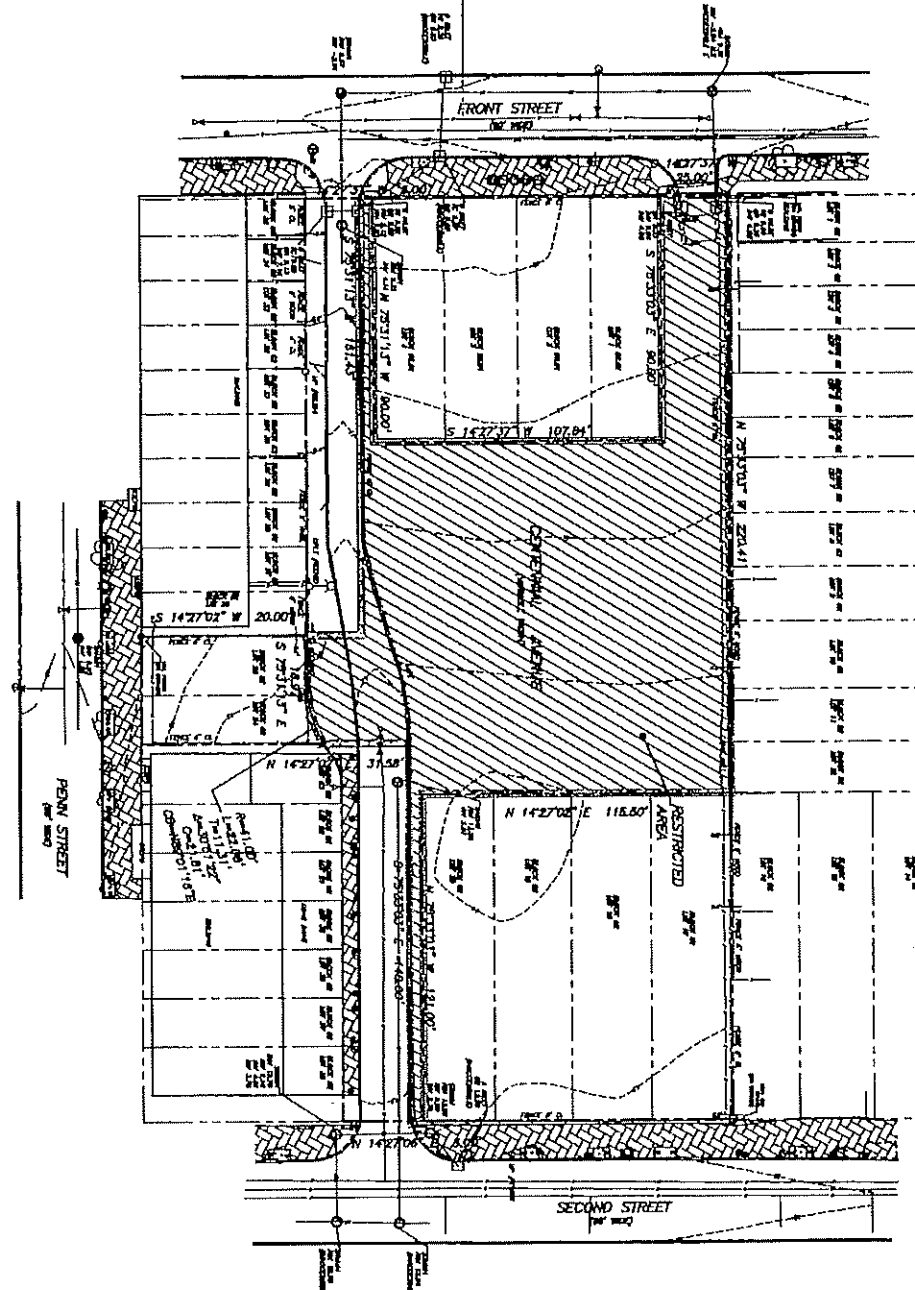
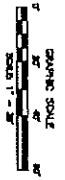

LEGEND

○	Corner of Lot
○	Corner of Block
○	Corner of City Block
○	Corner of Township
○	Corner of County
○	Corner of State
○	Corner of Federal
○	Corner of National
○	Corner of International
○	Corner of World
○	Corner of Universe
○	Corner of Cosmos
○	Corner of Galaxy
○	Corner of Solar System
○	Corner of Planet
○	Corner of Continent
○	Corner of Country
○	Corner of State
○	Corner of County
○	Corner of Township
○	Corner of City Block
○	Corner of Lot

POWER BY
 COMBATING TERRORISM WORKSHEET
 PREPARED BY: [Name]
 DATE: [Date]

RESTRICTED AREA EXHIBIT
 CAMDEN REDEVELOPMENT AGENCY AND
 BARREL COMPANY SITE
 BLOCK 62.01, LOTS 1-4, BLOCK 62, LOTS
 17-20, 24, 25 & CENTRAL AVENUE
 CAMDEN, COOK COUNTY, ILL. 62702

NO.	DATE	DESCRIPTION

ADAM R. GRANT
 PROFESSIONAL LAND SURVEYOR, NEW JERSEY LIC. NO. 34204537702

Exhibit A-3



EXHIBIT A-3: PROPERTY MAP

 Site Boundary



PROJECT NAME: ABC BARREL COMPANY/CENTENNIAL AVE
PROJECT ADDRESS: 308-322 NORTH FRONT STREET, CAMDEN, NJ
NJDEP SRP PI#: 006594
DATE: FEBRUARY 2018

0 25 50 100 Feet

Exhibit B-1

Asphalt Cap:



2-inch bituminous surface coat
 4-inch bituminous base coat
 6-inch dense graded aggregate

Soil Cap:

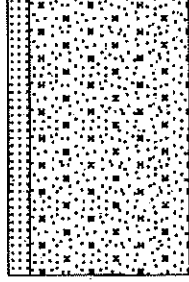

0.25 ft topsoil
 1.75 ft virgin certified clean fill

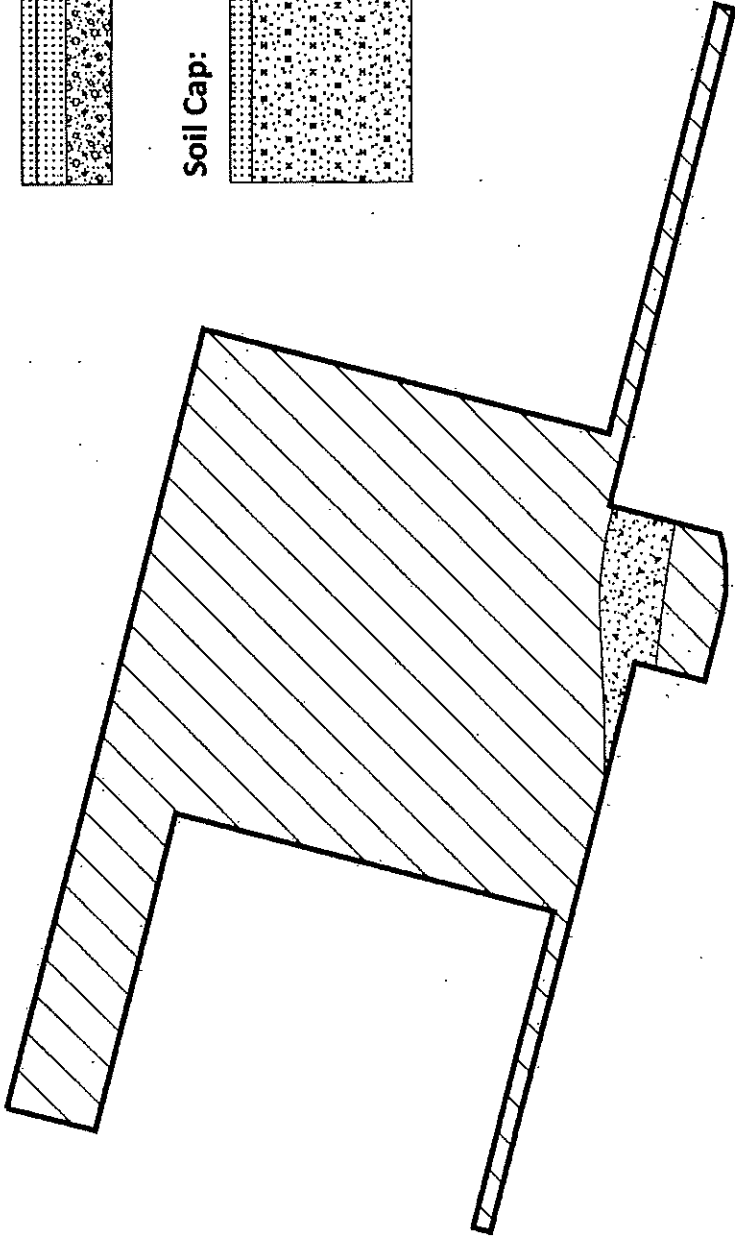

Note: Historic fill extends across the entire restricted area.

EXHIBIT B-1: RESTRICTED AREA MAP

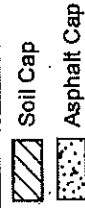

PROJECT NAME: ABC BARREL COMPANY/CENTENNIAL AVE
PROJECT ADDRESS: 308-322 NORTH FRONT STREET, CAMDEN, NJ
NJDEP SRP PI#: 006594
DATE: FEBRUARY 2018



Exhibit B-2

Exhibit B-2

The restricted area, which comprises the Centennial Avenue Park site, is underlain by historic fill. The fill material observed consists of wood, brick and metal pieces, mixed with soil. The fill begins beneath the overlying engineering controls (caps), which corresponds to 2 ft deep in soil-capped areas and 1 ft deep in the asphalt-capped area. The fill extends to a maximum depth of 12 ft deep. The historic fill may include, but is not limited to, contaminants such as polycyclic aromatic hydrocarbons (PAHs), and metals.

Exhibit C-1

Exhibit C-1

This Deed Notice will serve as an institutional control for the parcel described as "Centennial Avenue Park" (reference Exhibit A) in the City of Camden, New Jersey. This Deed Notice is necessary due to on-site contamination that exceeds NJDEP Residential Direct Contact Soil Remediation Standards.

- A. The Centennial Avenue Park site is located in the City of Camden, Camden County, New Jersey, and occupies a portion of Former Block 62, Lots 38 and 45, on the tax map of the City of Camden. The site measures 21,715 feet, or approximately 0.5 acres. The area restricted by this Deed Notice is the entire site.
- B. The restrictions on the parcel by institution of this Deed Notice include implementation, maintenance and monitoring of engineering controls in accordance with a soil Remedial Action Permit that the owner will obtain from NJDEP. In addition, the Deed Notice provides certain restrictions in the case of changing land use, changing ownership or zoning, altering, improving or disturbing the site, and responding to emergencies.
- C. The objective of the restrictions is to provide protection of human health and the environment and to comply with New Jersey Department of Environmental Protection (NJDEP) requirements.

Exhibit C-2

Exhibit C-2 – Narrative Description of Soil Cap

A cap was installed at the parcel described as “Centennial Avenue Park” (reference Exhibit A) in the City of Camden, New Jersey. This cap is necessary due to on-site contamination that exceeds NJDEP Non-Residential Direct Contact Soil Remediation Standards.

- A. The soil cap was installed pursuant to an NJDEP-approved Remedial Action Workplan. It measures 20,815 square feet and consists of 0.25 feet of topsoil underlain by 1.75 feet of clean fill.
- B. The objectives of the cap are to:
 - 1. Prevent direct contact with contaminated soil
 - 2. Eliminate run-off of contaminated soil
 - 3. Eliminate wind generation of contaminated airborne particulates
- C. The cap is intended to function as a physical barrier that will prevent exposure to contaminated soil.

Exhibit C-2 – Narrative Description of Asphalt Cap

A cap was installed at the parcel described as “Centennial Avenue Park” (reference Exhibit A) in the City of Camden, New Jersey. This cap is necessary due to on-site contamination that exceeds NJDEP Non-Residential Direct Contact Soil Remediation Standards.

- A. The asphalt cap was installed as part of the creation of a roadway to support adjacent off-site development. It measures approximately 900 square feet and consists of a 2-inch bituminous surface layer, underlain by a 4-inch bituminous base layer, underlain by 6 inches of dense graded aggregate.
- B. The objectives of the cap are to:
 - 1. Prevent direct contact with contaminated soil
 - 2. Eliminate run-off of contaminated soil
 - 3. Eliminate wind generation of contaminated airborne particulates
- C. The cap is intended to function as a physical barrier that will prevent exposure to contaminated soil.

APPENDIX F
LABORATORY REDUCED DELIVERABLES
(SUBMITTED SEPARATELY)



APPENDIX G
CLEAN FILL DOCUMENTATION



**Camden Redevelopment
Agency (CRA)
ABC Barrel Site
Remediation and Harrison
Ave. Landfill Interim
Closure**

**CERTIFIED CLEAN FILL
HANSON AGGREGATES, BERLIN, NJ**



February 3, 2017

**Prepared For:
Camden Redevelopment
Agency (CRA)
520 Market Street, Suite 1300
Camden, NJ 08101**

**Prepared By:
The Ambient Group, LLC.
222 Thies Road
Sewell, NJ 08080
856-582-1765**

Hanson Aggregates

Materials Northeast

1101 Railroad Avenue
Newport, NJ 08345

Phone 856 447-4294
Fax 856 447-4298

www.lehighhanson.com

Company : The Ambient Group
ATTN: Julian Heal

Feb. 3, 2017

RE: Certified Clean Fill

Location: Front & Penn St. ABC Barrel Project
Camden, NJ.

To Whom It May Concern:

Hanson Aggregates BMC, Inc. hereby certifies that the material which is being sold to The Ambient Group and being delivered to the above mentioned site is from a virgin source and is free of any hazardous waste and/or contaminants. This material will be picked up from our mining operation in Berlin, New Jersey. The following information is pertinent to this mine source:

Name of Supplier and Source:

Hanson Aggregates BMC, Inc.
Berlin Plant

Street, Town, Lot and Block, County, State:

127 Williamstown Road
Berlin, NJ 08009
Winslow Township
Block 1701, Lots 12,16,17,18,19,20,21
Camden County, New Jersey

Brief History of Site of Fill Source:

The Hanson Aggregate BMC, Inc. Berlin Plant is a sand and gravel plant opened in the late 1920's and operated continuously to present. The operation has maintained the State and Local permits as required.

Hanson Aggregates BMC, Inc. certifies that the Berlin site produces Virgin material and that no chemicals or additives are used in producing the product.

Should there be any questions or need for additional information concerning this material, please feel free to contact me at one of the numbers above.

Sincerely,

Michael Perry
Senior Sales Rep.

Particle Size Distribution Report

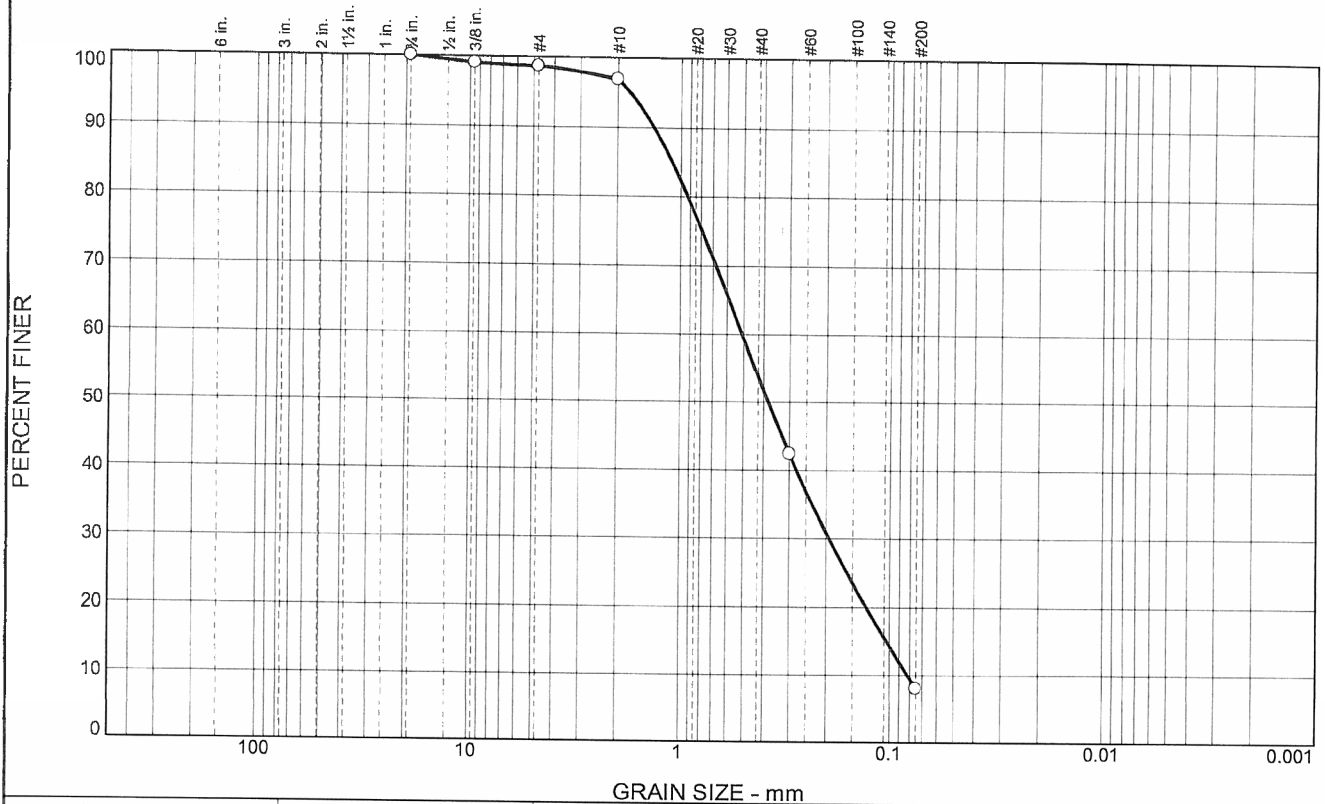

% Cobbles	% Gravel		% Sand			% Fines	
	Coarse	Fine	Coarse	Medium	Fine	Silt	Clay
0.0	0.0	1.4	1.7	43.0	45.9	8.0	

SIEVE SIZE	PERCENT FINER	SPEC.* PERCENT	PASS? (X=NO)
3/4"	100.0		
3/8"	99.0		
#4	98.6		
#10	96.9		
#50	42.4		
#200	8.0		

Material Description
Brown poorly graded SAND with silt\clay

Atterberg Limits
LL= PL= PI=

Coefficients
D₈₅= 1.1001 D₆₀= 0.5076 D₅₀= 0.3794
D₃₀= 0.1942 D₁₅= 0.1033 D₁₀= 0.0821
C_u= 6.18 C_c= 0.90

Classification
USCS= SP-SMSC

Remarks
Sampled By: Client
Delivered By: Client

* (no specification provided)

Location: Berlin Plant Sample Number: WGCC-1 Depth: Bulk Date: 1/17/17

 <p style="font-size: small;">www.craigtestinglabs.com Mays Landing, NJ 609-625-1700</p>	Client: Hanson & Son Project: 2017 QA/QC	
	Project No: 719502	Plate WGCC-1

COMPACTION TEST REPORT

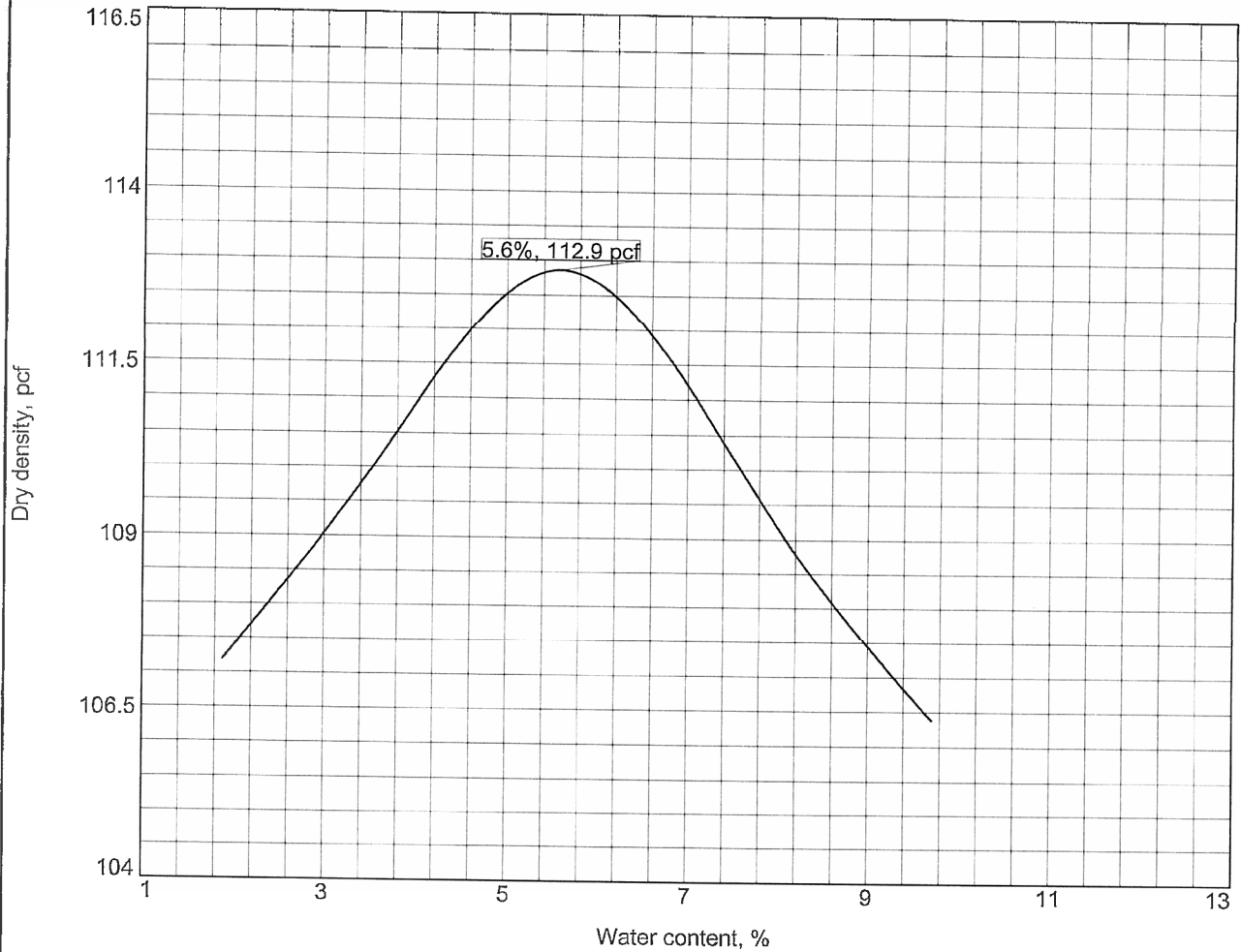

Test specification: ASTM D 1557-12 Method B Modified

Elev/ Depth	Classification		Nat. Moist.	Sp.G.	LL	PI	% > 3/8 in.	% < No.200
	USCS	AASHTO						
Bulk	SP-SM\SC						1.0	8.0

TEST RESULTS	MATERIAL DESCRIPTION
Maximum dry density = 112.9 pcf Optimum moisture = 5.6 %	Brown poorly graded SAND with silt\clay

Project No. 719502 Client: Hanson & Son Project: 2017 QA/QC Location: Berlin Plant Sample Number: WGCC-1	Remarks: Sampled By: Client Delivered By: Client
--	---



CRAIG TESTING LABORATORIES, INC.

Mays Landing, NJ www.craigtest.com (609) 625-1700

Plate WGCC-1



Plant: 32411

Berlin

368 New Brooklyn Road
Berlin, NJ 08009
856-809-0142

3/1/2017 07:20 In: 6:55:04
Customer: 8638404 THE AMBIENT GROUP LLC
Order : 950949 Camden, NJ. ABC Barrel Project
P.O. :

Tkt. No. 1006027051

Product 114203
Bank Run
S.O. Info: Camden, NJ.
Ship Ref: 327 N. Front St



	Pounds	Kilo
Gross	75,880	34,419
Tare	24,620	11,167
Net	51,260	23,251

25.63 Ton 23.25

	UNIT	TOTALS
Material:		
Freight:		
Tax:		
Fee / Fuel:		
Other Chrg: No		

Today Tons:	25.63	Loads:	
Tons To Date:	227.31		1
Today Tonnes	23.25		
Tonnes To Date:	206.21		

Carrier : 2346970 GEORGE LAZOS TRUCKING
Vehicle: LG004 AP213T
License: LG004
MaxGVW: 80,000
Received: _____
Weighmaster: Colleen LeSage

By acceptance of this ticket (with or without signature), driver accepts on behalf of themselves/their employer sole responsibility to ensure that the load received is within the weight limit authorized by law and shall hold seller harmless against any and all claims with respect to same CURB DELIVERY ONLY. NOT RESPONSIBLE FOR ANY DAMAGE BEYOND CURB.

Cust: _____

P/D Status: Deliver

Customer Copy

Scale: 1



Plant: 32411

Berlin

368 New Brooklyn Road
Berlin, NJ 08009
856-809-0142

3/1/2017 07:24 In: 6:58:00
Customer: 8638404 THE AMBIENT GROUP LLC
Order : 950949 Camden, NJ. ABC Barrel Project
P.O. :

Tkt. No. 1006027052

Product 114203
Bank Run
S.O. Info: Camden, NJ.
Ship Ref: 327 N. Front St



	Pounds	Kilo
Gross	78,580	35,643
Tare	27,400	12,428
Net	51,180	23,215

25.59 Ton 23.21

	UNIT	TOTALS
Material:		
Freight:		
Tax:		
Fee / Fuel:		
Other Chrg: No		

Today Tons:	51.22	Loads:	
Tons To Date:	252.90		2
Today Tonnes	46.47		
Tonnes To Date:	229.43		

Carrier : 9249110 CLM CONTRACTING LLC
Vehicle: CLM6 CLM6
License: AT597T
MaxGVW: 80,000
Received: _____
Weighmaster: Colleen LeSage

By acceptance of this ticket (with or without signature), driver accepts on behalf of themselves/their employer sole responsibility to ensure that the load received is within the weight limit authorized by law and shall hold seller harmless against any and all claims with respect to same CURB DELIVERY ONLY. NOT RESPONSIBLE FOR ANY DAMAGE BEYOND CURB.

Cust: _____

P/D Status: Deliver

Customer Do Not Accept [3]

Scale: 1



Plant: 32411

Berlin

368 New Brooklyn Road
Berlin, NJ 08009
856-809-0142

3/1/2017 07:50 In: 7:34:54
Customer: 8638404 THE AMBIENT GROUP LLC
Order: 950949 Camden, NJ. ABC Barrel Project
P.O.:

Tkt. No. 1006027054

Product 114203
Bank Run
S.O. Info: Camden, NJ.
Ship Ref: 327 N. Front St



	Pounds	Kilo
Gross	77,900	35,335
Tare	28,820	13,073
Net	49,080	22,262
	24.54 Ton	22.26

	UNIT	TOTALS
Material:		
Freight:		
Tax:		
Fee / Fuel:		
Other Chrg: No		

Today Tons:	75.76	Loads:
Tons To Date:	277.44	3
Today Tonnes	68.73	
Tonnes To Date:	251.69	

Carrier : 8040648 GJ SCOTT LLC
Vehicle: GS14 GS14
License: AS672T
MaxGVW: 80,000

By acceptance of this ticket (with or without signature), driver accepts on behalf of themselves/their employer sole responsibility to ensure that the load received is within the weight limit authorized by law and shall hold seller harmless against any and all claims with respect to same CURB DELIVERY ONLY. NOT RESPONSIBLE FOR ANY DAMAGE BEYOND CURB.

Received: _____
Weighmaster: Colleen LeSage

Cust: _____

P/D Status: Deliver

Customer Copy

Scale: 1



Plant: 32411

Berlin

368 New Brooklyn Road
Berlin, NJ 08009
856-809-0142

3/1/2017 07:53 In: 7:36:16
Customer: 8638404 THE AMBIENT GROUP LLC
Order: 950949 Camden, NJ. ABC Barrel Project
P.O.:

Tkt. No. 1006027055

Product 114203
Bank Run
S.O. Info: Camden, NJ.
Ship Ref: 327 N. Front St



	Pounds	Kilo
Gross	78,800	35,743
Tare	28,620	12,982
Net	50,180	22,761
	25.09 Ton	22.76

	UNIT	TOTALS
Material:		
Freight:		
Tax:		
Fee / Fuel:		
Other Chrg: No		

Today Tons:	100.85	Loads:
Tons To Date:	302.53	4
Today Tonnes	91.49	
Tonnes To Date:	274.45	

Carrier : 8040648 GJ SCOTT LLC
Vehicle: GS15 GS15
License: AS672T
MaxGVW: 80,000

By acceptance of this ticket (with or without signature), driver accepts on behalf of themselves/their employer sole responsibility to ensure that the load received is within the weight limit authorized by law and shall hold seller harmless against any and all claims with respect to same CURB DELIVERY ONLY. NOT RESPONSIBLE FOR ANY DAMAGE BEYOND CURB.

Received: _____
Weighmaster: Colleen LeSage

Cust: _____

P/D Status: Deliver

Customer Do Not Accept [2]

Scale: 1



Plant: 32411

Berlin

368 New Brooklyn Road
Berlin, NJ 08009
856-809-0142

3/1/2017 07:57

In: 7:37:20

Customer: 8638404 THE AMBIENT GROUP LLC

Order: 950949 Camden, NJ. ABC Barrel Project

P.O.:

Tkt. No. 1006027056

Product 114203
Bank Run
S.O. Info: Camden, NJ.
Ship Ref: 327 N. Front St



	Pounds	Kilo
Gross	76,720	34,800
Tare	28,760	13,045
Net	47,960	21,754
	23.98 Ton	21.75

UNIT	TOTALS
Material:	
Freight:	
Tax:	
Fee / Fuel:	
Other Chrg: No	

Today Tons:	124.83	Loads:
Tons To Date:	326.51	5
Today Tonnes	113.24	
Tonnes To Date:	296.20	

Carrier: 9109539 VML TRUCKING2 LLC
Vehicle: VML102 XASG14
License: XASG14
MaxGVW: 80,000.
Received: _____
Weighmaster: Colleen LeSage

*By acceptance of this ticket (with or without signature), driver accepts on behalf of themselves/their employer sole responsibility to ensure that the load received is within the weight limit authorized by law and shall hold seller harmless against any and all claims with respect to same
CURB DELIVERY ONLY. NOT RESPONSIBLE FOR ANY DAMAGE BEYOND CURB.*

Cust: _____

P/D Status: Deliver

Customer Do Not Accept [2] Scale: 1



Plant: 32411

Berlin

368 New Brooklyn Road
Berlin, NJ 08009
856-809-0142

2/28/2017 13:55

In: 13:40:29

Customer: 8638404 THE AMBIENT GROUP LLC

Order: 950949 Camden, NJ. ABC Barrel Project

P.O.:

Tkt. No. 1006027045

Product 114203
Bank Run
S.O. Info: Camden, NJ.
Ship Ref: 327 N. Front St



	Pounds	Kilo
Gross	78,500	35,607
Tare	28,360	12,864
Net	50,140	22,743
	25.07 Ton	22.74

UNIT	TOTALS
Material:	
Freight:	
Tax:	
Fee / Fuel:	
Other Chrg: No	

Today Tons:	151.01	Loads:
Tons To Date:	176.52	6
Today Tonnes	136.99	
Tonnes To Date:	160.14	

Carrier: 8040648 GJ SCOTT LLC
Vehicle: GS15 GS15
License: AS672T
MaxGVW: 80,000
Received: _____
Weighmaster: Colleen LeSage

*By acceptance of this ticket (with or without signature), driver accepts on behalf of themselves/their employer sole responsibility to ensure that the load received is within the weight limit authorized by law and shall hold seller harmless against any and all claims with respect to same
CURB DELIVERY ONLY. NOT RESPONSIBLE FOR ANY DAMAGE BEYOND CURB.*

Cust: _____

P/D Status: Deliver

Customer Copy Scale: 1



Plant: 32411

Berlin
368 New Brooklyn Road
Berlin, NJ 08009
856-809-0142

3/1/2017 09:37 In :
Customer: 8638404 THE AMBIENT GROUP LLC
Order : 950949 Camden, NJ. ABC Barrel Project
P.O. :

Tkt. No. 1006027066



Product 114203
Bank Run
S.O. Info: Camden, NJ.
Ship Ref: 327 N. Front St

	Pounds	Kilo
Gross	79,220	35,934
Tare	28,820 *	13,073
Net	50,400	22,861

25.20 Ton 22.86
* Predetermined Tare

Today Tons:	150.03	Loads:
Tons To Date:	351.71	6
Today Tonnes	136.10	
Tonnes To Date:	319.07	

By acceptance of this ticket (with or without signature), driver accepts on behalf of themselves/their employer sole responsibility to ensure that the load received is within the weight limit authorized by law and shall hold seller harmless against any and all claims with respect to same CURB DELIVERY ONLY. NOT RESPONSIBLE FOR ANY DAMAGE BEYOND CURB.

	UNIT	TOTALS
Material:		
Freight:		
Tax:		
Fee / Fuel:		
Other Chrg: No		

Carrier : 8040648 GJ SCOTT LLC
Vehicle: GS14 GS14
License: As672T
MaxGVW: 80,000

Received:
Weighmaster: Colleen LeSage

Cust: _____

P/D Status: Deliver

Customer Do Not Accept [3] Scale: 1



Plant: 32411

Berlin
368 New Brooklyn Road
Berlin, NJ 08009
856-809-0142

2/28/2017 14:00 In :
Customer: 8638404 THE AMBIENT GROUP LLC
Order : 950949 Camden, NJ. ABC Barrel Project
P.O. :

Tkt. No. 1006027046



Product 114203
Bank Run
S.O. Info: Camden, NJ.
Ship Ref: 327 N. Front St

	Pounds	Kilo
Gross	79,100	35,879
Tare	28,780 *	13,054
Net	50,320	22,825

25.16 Ton 22.82
* Predetermined Tare

Today Tons:	176.17	Loads:
Tons To Date:	201.68	7
Today Tonnes	159.82	
Tonnes To Date:	182.96	

By acceptance of this ticket (with or without signature), driver accepts on behalf of themselves/their employer sole responsibility to ensure that the load received is within the weight limit authorized by law and shall hold seller harmless against any and all claims with respect to same CURB DELIVERY ONLY. NOT RESPONSIBLE FOR ANY DAMAGE BEYOND CURB.

	UNIT	TOTALS
Material:		
Freight:		
Tax:		
Fee / Fuel:		
Other Chrg: No		

Carrier : 8040648 GJ SCOTT LLC
Vehicle: GS14 GS14
License: As672T
MaxGVW: 80,000

Received: _____
Weighmaster: Colleen LeSage

Cust: _____

P/D Status: Deliver

Customer Do Not Accept [2] Scale: 1



Plant: 32411

Berlin

368 New Brooklyn Road
Berlin, NJ 08009
856-809-0142

3/1/2017 09:38 In :

Customer: 8638404 THE AMBIENT GROUP LLC

Order : 950949 Camden, NJ. ABC Barrel Project

P.O. :

Tkt. No. 1006027067



Product 114203

Bank Run

S.O. Info: Camden, NJ.

Ship Ref: 327 N. Front St

	Pounds	Kilo
Gross	79,960	36,269
Tare	28,620 *	12,982
Net	51,340	23,287

25.67 Ton 23.29

* Predetermined Tare

Today Tons:	175.70	Loads:	
Tons To Date:	377.38		7
Today Tonnes	159.39		
Tonnes To Date:	342.35		

By acceptance of this ticket (with or without signature), driver accepts on behalf of themselves/their employer sole responsibility to ensure that the load received is within the weight limit authorized by law and shall hold seller harmless against any and all claims with respect to same CURB DELIVERY ONLY. NOT RESPONSIBLE FOR ANY DAMAGE BEYOND CURB.

UNIT	TOTALS
Material:	
Freight:	
Tax:	
Fee / Fuel:	
Other Chrg: No	

Carrier : 8040648 GJ SCOTT LLC

Vehicle: GS15 GS15

License: AS672T

MaxGVW: 80,000

Received: _____ Cust: _____

Weighmaster: Colleen LeSage

P/D Status: Deliver

Customer Do Not Accept [3] Scale: 1



Plant: 32411

Berlin

368 New Brooklyn Road
Berlin, NJ 08009
856-809-0142

3/1/2017 09:41 In :

Customer: 8638404 THE AMBIENT GROUP LLC

Order : 950949 Camden, NJ. ABC Barrel Project

P.O. :

Tkt. No. 1006027068



Product 114203

Bank Run

S.O. Info: Camden, NJ.

Ship Ref: 327 N. Front St

	Pounds	Kilo
Gross	78,520	35,616
Tare	27,400 *	12,428
Net	51,120	23,188

25.56 Ton 23.19

* Predetermined Tare

Today Tons:	201.26	Loads:	
Tons To Date:	402.94		8
Today Tonnes	182.58		
Tonnes To Date:	365.54		

By acceptance of this ticket (with or without signature), driver accepts on behalf of themselves/their employer sole responsibility to ensure that the load received is within the weight limit authorized by law and shall hold seller harmless against any and all claims with respect to same CURB DELIVERY ONLY. NOT RESPONSIBLE FOR ANY DAMAGE BEYOND CURB.

UNIT	TOTALS
Material:	
Freight:	
Tax:	
Fee / Fuel:	
Other Chrg: No	

Carrier : 9249110 CLM CONTRACTING LLC

Vehicle: CLM6 CLM6

License: AT597T

MaxGVW: 80,000

Received: _____ Cust: _____

Weighmaster: Colleen LeSage

P/D Status: Deliver

Customer Do Not Accept [1] Scale: 1



Plant: 32411

Berlin

368 New Brooklyn Road
Berlin, NJ 08009
856-809-0142

3/1/2017 09:45 In :
Customer: 8638404 THE AMBIENT GROUP LLC
Order : 950949 Camden, NJ. ABC Barrel Project
P.O. :

Tkt. No. 1006027069

Product 114203
Bank Run
S.O. Info: Camden, NJ.
Ship Ref: 327 N. Front St



	Pounds	Kilo
Gross	77,360	35,090
Tare	24,620 *	11,167
Net	52,740	23,922

26.37 Ton 23.92

* Predetermined Tare

	UNIT	TOTALS
Material:		
Freight:		
Tax:		
Fee / Fuel:		
Other Chrg: No		

Today Tons:	227.63	Loads:
Tons To Date:	429.31	9
Today Tonnes	206.50	
Tonnes To Date:	389.46	

Carrier : 2346970 GEORGE LAZOS TRUCKING
Vehicle: LG004 XP213T
License: LG004
MaxGVW: 80,000
Received: _____
Weighmaster: Colleen LeSage

By acceptance of this ticket (with or without signature), driver accepts on behalf of themselves/their employer sole responsibility to ensure that the load received is within the weight limit authorized by law and shall hold seller harmless against any and all claims with respect to same CURB DELIVERY ONLY .NOT RESPONSIBLE FOR ANY DAMAGE BEYOND CURB.

Cust: _____

P/D Status: Deliver

Customer Copy

Scale: 1



Plant: 32411

Berlin

368 New Brooklyn Road
Berlin, NJ 08009
856-809-0142

3/1/2017 10:04 In :
Customer: 8638404 THE AMBIENT GROUP LLC
Order : 950949 Camden, NJ. ABC Barrel Project
P.O. :

Tkt. No. 1006027071

Product 114203
Bank Run
S.O. Info: Camden, NJ.
Ship Ref: 327 N. Front St



	Pounds	Kilo
Gross	77,380	35,099
Tare	28,760 *	13,045
Net	48,620	22,054

24.31 Ton 22.05

* Predetermined Tare

	UNIT	TOTALS
Material:		
Freight:		
Tax:		
Fee / Fuel:		
Other Chrg: No		

Today Tons:	251.94	Loads:
Tons To Date:	453.62	10
Today Tonnes	228.56	
Tonnes To Date:	411.52	

Carrier : 9109539 VML TRUCKING2 LLC
Vehicle: VML102 XASG14
License: XASG14
MaxGVW: 80,000
Received: _____
Weighmaster: Colleen LeSage

By acceptance of this ticket (with or without signature), driver accepts on behalf of themselves/their employer sole responsibility to ensure that the load received is within the weight limit authorized by law and shall hold seller harmless against any and all claims with respect to same CURB DELIVERY ONLY .NOT RESPONSIBLE FOR ANY DAMAGE BEYOND CURB.

Cust: _____

P/D Status: Deliver

Customer Do Not Accept [2]

Scale: 1



Plant: 32411

Berlin
368 New Brooklyn Road
Berlin, NJ 08009
856-809-0142

3/1/2017 11:10 In :
Customer: 8638404 THE AMBIENT GROUP LLC
Order : 950949 Camden, NJ. ABC Barrel Project
P.O. :

Tkt. No. 1006027076



Product 114203
Bank Run
S.O. Info: Camden, NJ.
Ship Ref: 327 N. Front St

	Pounds	Kilo
Gross	79,440	36,033
Tare	28,820 *	13,073
Net	50,620	22,961

25.31 Ton 22.96
* Predetermined Tare

Today Tons:	277.25	Loads:
Tons To Date:	478.93	11
Today Tonnes	251.52	
Tonnes To Date:	434.48	

By acceptance of this ticket (with or without signature), driver accepts on behalf of themselves/their employer sole responsibility to ensure that the load received is within the weight limit authorized by law and shall hold seller harmless against any and all claims with respect to same CURB DELIVERY ONLY. NOT RESPONSIBLE FOR ANY DAMAGE BEYOND CURB.

Material:	UNIT	TOTALS
Freight:		
Tax:		
Fee / Fuel:		
Other Chrg: No		

Carrier : 8040648 GJ SCOTT LLC
Vehicle: GS14 GS14
License: AS672T
MaxGVW: 80,000

Received:
Weighmaster: Colleen LeSage

Cust: _____

P/D Status: Deliver

Customer Do Not Accept [3] Scale: 1



Plant: 32411

Berlin
368 New Brooklyn Road
Berlin, NJ 08009
856-809-0142

3/1/2017 11:13 In :
Customer: 8638404 THE AMBIENT GROUP LLC
Order : 950949 Camden, NJ. ABC Barrel Project
P.O. :

Tkt. No. 1006027077



Product 114203
Bank Run
S.O. Info: Camden, NJ.
Ship Ref: 327 N. Front St

	Pounds	Kilo
Gross	78,560	35,634
Tare	28,620 *	12,982
Net	49,940	22,652

24.97 Ton 22.65
* Predetermined Tare

Today Tons:	302.22	Loads:
Tons To Date:	503.90	12
Today Tonnes	274.17	
Tonnes To Date:	457.13	

By acceptance of this ticket (with or without signature), driver accepts on behalf of themselves/their employer sole responsibility to ensure that the load received is within the weight limit authorized by law and shall hold seller harmless against any and all claims with respect to same CURB DELIVERY ONLY. NOT RESPONSIBLE FOR ANY DAMAGE BEYOND CURB.

Material:	UNIT	TOTALS
Freight:		
Tax:		
Fee / Fuel:		
Other Chrg: No		

Carrier : 8040648 GJ SCOTT LLC
Vehicle: GS15 GS15
License: AS672T
MaxGVW: 80,000

Received:
Weighmaster: Colleen LeSage

Cust: _____

P/D Status: Deliver

Customer Do Not Accept [3] Scale: 1



Plant: 32411

Berlin

368 New Brooklyn Road
Berlin, NJ 08009
856-809-0142

3/1/2017 11:17 In :
Customer: 8638404 THE AMBIENT GROUP LLC
Order : 950949 Camden, NJ. ABC Barrel Project
P.O. :

Tkt. No. 1006027078

Product 114203
Bank Run
S.O. Info: Camden, NJ.
Ship Ref: 327 N. Front St



	Pounds	Kilo
Gross	76,020	34,482
Tare	24,620 *	11,167
Net	51,400	23,315

25.70 Ton 23.31

* Predetermined Tare

	UNIT	TOTALS
Material:		
Freight:		
Tax:		
Fee / Fuel:		
Other Chrg:	No	

Today Tons:	327.92	Loads:
Tons To Date:	529.60	13
Today Tonnes	297.48	
Tonnes To Date:	480.45	

Carrier : 2346970 GEORGE LAZOS TRUCKING
Vehicle: LG004 AP213T
License: LG004
MaxGVW: 80,000
Received: _____
Weighmaster: Colleen LeSage

By acceptance of this ticket (with or without signature), driver accepts on behalf of themselves/their employer sole responsibility to ensure that the load received is within the weight limit authorized by law and shall hold seller harmless against any and all claims with respect to same CURB DELIVERY ONLY. NOT RESPONSIBLE FOR ANY DAMAGE BEYOND CURB.

Cust: _____

P/D Status: Deliver

Customer Copy

Scale: 1



Plant: 32411

Berlin

368 New Brooklyn Road
Berlin, NJ 08009
856-809-0142

3/1/2017 11:44 In :
Customer: 8638404 THE AMBIENT GROUP LLC
Order : 950949 Camden, NJ. ABC Barrel Project
P.O. :

Tkt. No. 1006027079

Product 114203
Bank Run
S.O. Info: Camden, NJ.
Ship Ref: 327 N. Front St



	Pounds	Kilo
Gross	77,840	35,308
Tare	28,760 *	13,045
Net	49,080	22,262

24.54 Ton 22.26

* Predetermined Tare

	UNIT	TOTALS
Material:		
Freight:		
Tax:		
Fee / Fuel:		
Other Chrg:	No	

Today Tons:	352.46	Loads:
Tons To Date:	554.14	14
Today Tonnes	319.75	
Tonnes To Date:	502.71	

By acceptance of this ticket (with or without signature), driver accepts on behalf of themselves/their employer sole responsibility to ensure that the load received is within the weight limit authorized by law and shall hold seller harmless against any and all claims with respect to same CURB DELIVERY ONLY. NOT RESPONSIBLE FOR ANY DAMAGE BEYOND CURB.

Cust: _____

Carrier : 9109539 VML TRUCKING2 LLC
Vehicle: VML102 XASG14
License: XASG14
MaxGVW: 80,000
Received: _____
Weighmaster: Colleen LeSage

P/D Status: Deliver

Customer Do Not Accept [3]

Scale: 1



Plant: 32411

Berlin

368 New Brooklyn Road
Berlin, NJ 08009
856-809-0142

3/1/2017 11:47

In :

Customer: 8638404 THE AMBIENT GROUP LLC

Order : 950949 Camden, NJ. ABC Barrel Project

P.O. :

Tkt. No. 1006027080



Product 114203

Bank Run

S.O. Info: Camden, NJ.

Ship Ref: 327 N. Front St

	Pounds	Kilo
Gross	78,020	35,389
Tare	27,400 *	12,428
Net	50,620	22,961

25.31 Ton 22.96

* Predetermined Tare

Today Tons:	377.77	Loads:
Tons To Date:	579.45	15
Today Tonnes	342.71	
Tonnes To Date:	525.67	

By acceptance of this ticket (with or without signature), driver accepts on behalf of themselves/their employer sole responsibility to ensure that the load received is within the weight limit authorized by law and shall hold seller harmless against any and all claims with respect to same CURB DELIVERY ONLY. NOT RESPONSIBLE FOR ANY DAMAGE BEYOND CURB.

Received: _____ Cust: _____

	UNIT	TOTALS
Material:		
Freight:		
Tax:		
Fee / Fuel:		
Other Chrg: No		

Carrier : 9249110 CLM CONTRACTING LLC

Vehicle: CLM6 CLM6

License: AT597T

MaxGVW: 80,000

Received: _____

Weighmaster: Colleen LeSage

P/D Status: Deliver

Customer Do Not Accept [3] Scale: 1



Plant: 32411

Berlin

368 New Brooklyn Road
Berlin, NJ 08009
856-809-0142

3/1/2017 12:47

In :

Customer: 8638404 THE AMBIENT GROUP LLC

Order : 950949 Camden, NJ. ABC Barrel Project

P.O. :

Tkt. No. 1006027094



Product 114203

Bank Run

S.O. Info: Camden, NJ.

Ship Ref: 327 N. Front St

	Pounds	Kilo
Gross	77,220	35,026
Tare	28,820 *	13,073
Net	48,400	21,954

24.20 Ton 21.95

* Predetermined Tare

Today Tons:	401.97	Loads:
Tons To Date:	603.65	16
Today Tonnes	364.66	
Tonnes To Date:	547.62	

By acceptance of this ticket (with or without signature), driver accepts on behalf of themselves/their employer sole responsibility to ensure that the load received is within the weight limit authorized by law and shall hold seller harmless against any and all claims with respect to same CURB DELIVERY ONLY. NOT RESPONSIBLE FOR ANY DAMAGE BEYOND CURB.

Received: _____ Cust: _____

	UNIT	TOTALS
Material:		
Freight:		
Tax:		
Fee / Fuel:		
Other Chrg: No		

Carrier : 8040648 GJ SCOTT LLC

Vehicle: GS14 GS14

License: As672T

MaxGVW: 80,000

Received: _____

Weighmaster: Colleen LeSage

P/D Status: Deliver

Customer Do Not Accept [1] Scale: 1



Plant: 32411

Berlin

368 New Brooklyn Road
Berlin, NJ 08009
856-809-0142

3/1/2017 12:50

In :

Customer: 8638404 THE AMBIENT GROUP LLC

Order : 950949 Camden, NJ. ABC Barrel Project

P.O. :

Tkt. No. 1006027096

Product 114203



Bank Run

S.O. Info: Camden, NJ.

Ship Ref: 327 N. Front St

	Pounds	Kilo
Gross	79,340	35,988
Tare	28,620 *	12,982
Net	50,720	23,006

25.36 Ton 23.01

* Predetermined Tare

	UNIT	TOTALS
Material:		
Freight:		
Tax:		
Fee / Fuel:		
Other Chrg:	No	

Today Tons:	427.33	Loads:
Tons To Date:	629.01	17
Today Tonnes	387.67	
Tonnes To Date:	570.63	

By acceptance of this ticket (with or without signature), driver accepts on behalf of themselves/their employer sole responsibility to ensure that the load received is within the weight limit authorized by law and shall hold seller harmless against any and all claims with respect to same CURB DELIVERY ONLY. NOT RESPONSIBLE FOR ANY DAMAGE BEYOND CURB.

Carrier : 8040648 GJ SCOTT LLC

Vehicle: GS15 GS15

License: AS672T

MaxGVW: 80,000

Received:

Cust: _____

Weighmaster: Colleen LeSage

P/D Status: Deliver

Customer Copy

Scale: 1



Plant: 32411

Berlin

368 New Brooklyn Road
Berlin, NJ 08009
856-809-0142

3/1/2017 12:52

In :

Customer: 8638404 THE AMBIENT GROUP LLC

Order : 950949 Camden, NJ. ABC Barrel Project

P.O. :

Tkt. No. 1006027097

Product 114203



Bank Run

S.O. Info: Camden, NJ.

Ship Ref: 327 N. Front St

	Pounds	Kilo
Gross	77,940	35,353
Tare	24,620 *	11,167
Net	53,320	24,186

26.66 Ton 24.19

* Predetermined Tare

	UNIT	TOTALS
Material:		
Freight:		
Tax:		
Fee / Fuel:		
Other Chrg:	No	

Today Tons:	453.99	Loads:
Tons To Date:	655.67	18
Today Tonnes	411.85	
Tonnes To Date:	594.81	

By acceptance of this ticket (with or without signature), driver accepts on behalf of themselves/their employer sole responsibility to ensure that the load received is within the weight limit authorized by law and shall hold seller harmless against any and all claims with respect to same CURB DELIVERY ONLY. NOT RESPONSIBLE FOR ANY DAMAGE BEYOND CURB.

Carrier : 2346970 GEORGE LAZOS TRUCKING

Vehicle: LG004 AP213T

License: LG004

MaxGVW: 80,000

Received:

Cust: _____

Weighmaster: Colleen LeSage

P/D Status: Deliver

Customer Copy

Scale: 1



Plant: 32411

Berlin

368 New Brooklyn Road
Berlin, NJ 08009
856-809-0142

3/3/2017 07:12 In: 6:46:10
Customer: 8638404 THE AMBIENT GROUP LLC
Order: 950949 Camden, NJ. ABC Barrel Project
P.O.:

Tkt. No. 1006027130

Product 114203
Bank Run
S.O. Info: Camden, NJ.
Ship Ref: 327 N. Front St



	Pounds	Kilo
Gross	79,120	35,888
Tare	28,580	12,964
Net	50,540	22,925
	25.27 Ton	22.92

	UNIT	TOTALS
Material:		
Freight:		
Tax:		
Fee / Fuel:		
Other Chrg:	No	

Today Tons:	25.27	Loads:
Tons To Date:	680.94	1
Today Tonnes	22.92	
Tonnes To Date:	617.74	

Carrier: 8040648 GJ SCOTT LLC
Vehicle: GS15 GS15
License: AS672T
MaxGVW: 80,000
Received: EL
Weighmaster: Colleen LeSage

By acceptance of this ticket (with or without signature), driver accepts on behalf of themselves/their employer sole responsibility to ensure that the load received is within the weight limit authorized by law and shall hold seller harmless against any and all claims with respect to same CURB DELIVERY ONLY .NOT RESPONSIBLE FOR ANY DAMAGE BEYOND CURB.

Cust: _____

P/D Status: Deliver

Customer Copy

Scale: 1



Plant: 32411

Berlin

368 New Brooklyn Road
Berlin, NJ 08009
856-809-0142

3/3/2017 07:15 In: 6:51:35
Customer: 8638404 THE AMBIENT GROUP LLC
Order: 950949 Camden, NJ. ABC Barrel Project
P.O.:

Tkt. No. 1006027131

Product 114203
Bank Run
S.O. Info: Camden, NJ.
Ship Ref: 327 N. Front St



	Pounds	Kilo
Gross	77,840	35,308
Tare	27,360	12,410
Net	50,480	22,897
	25.24 Ton	22.90

	UNIT	TOTALS
Material:		
Freight:		
Tax:		
Fee / Fuel:		
Other Chrg:	No	

Today Tons:	50.51	Loads:
Tons To Date:	706.18	2
Today Tonnes	45.82	
Tonnes To Date:	640.64	

Carrier: 8040648 GJ SCOTT LLC
Vehicle: GS4 GS4
License: AJ118L
MaxGVW: 80,000
Received: L
Weighmaster: Colleen LeSage

By acceptance of this ticket (with or without signature), driver accepts on behalf of themselves/their employer sole responsibility to ensure that the load received is within the weight limit authorized by law and shall hold seller harmless against any and all claims with respect to same CURB DELIVERY ONLY .NOT RESPONSIBLE FOR ANY DAMAGE BEYOND CURB.

Cust: _____

P/D Status: Deliver

Customer Copy

Scale: 1



Plant: 32411

Berlin
368 New Brooklyn Road
Berlin, NJ 08009
856-809-0142

3/3/2017 07:18 In: 6:53:27
Customer: 8638404 THE AMBIENT GROUP LLC
Order: 950949 Camden, NJ. ABC Barrel Project
P.O.:

Tkt. No. 1006027132



Product 114203
Bank Run
S.O. Info: Camden, NJ.
Ship Ref: 327 N. Front St

	Pounds	Kilo
Gross	78,600	35,652
Tare	28,120	12,755
Net	50,480	22,897
	25.24 Ton	22.90

Today Tons:	75.75	Loads:
Tons To Date:	731.42	3
Today Tonnes	68.72	
Tonnes To Date:	663.53	

By acceptance of this ticket (with or without signature), driver accepts on behalf of themselves/their employer sole responsibility to ensure that the load received is within the weight limit authorized by law and shall hold seller harmless against any and all claims with respect to same CURB DELIVERY ONLY. NOT RESPONSIBLE FOR ANY DAMAGE BEYOND CURB.

	UNIT	TOTALS
Material:		
Freight:		
Tax:		
Fee / Fuel:		
Other Chrg: No		

Carrier: 8040648 GJ SCOTT LLC
Vehicle: GS17 GS17
License: AT640K
MaxGVW: 80,000

Received: _____ Cust: _____
Weighmaster: Colleen LeSage
P/D Status: Deliver

Customer Do Not Accept [3] Scale: 1



Plant: 32411

Berlin
368 New Brooklyn Road
Berlin, NJ 08009
856-809-0142

3/3/2017 08:49 In:
Customer: 8638404 THE AMBIENT GROUP LLC
Order: 950949 Camden, NJ. ABC Barrel Project
P.O.:

Tkt. No. 1006027140

Product 114203
Bank Run
S.O. Info: Camden, NJ.
Ship Ref: 327 N. Front St



	Pounds	Kilo
Gross	79,020	35,843
Tare	28,580 *	12,964
Net	50,440	22,879
	25.22 Ton	22.88

* Predetermined Tare

Today Tons:	100.97	Loads:
Tons To Date:	756.64	4
Today Tonnes	91.60	
Tonnes To Date:	686.41	

By acceptance of this ticket (with or without signature), driver accepts on behalf of themselves/their employer sole responsibility to ensure that the load received is within the weight limit authorized by law and shall hold seller harmless against any and all claims with respect to same CURB DELIVERY ONLY. NOT RESPONSIBLE FOR ANY DAMAGE BEYOND CURB.

	UNIT	TOTALS
Material:		
Freight:		
Tax:		
Fee / Fuel:		
Other Chrg: No		

Carrier: 8040648 GJ SCOTT LLC
Vehicle: GS15 GS15
License: AS672T
MaxGVW: 80,000

Received: _____ Cust: _____
Weighmaster: Colleen LeSage
P/D Status: Deliver

Customer Copy Scale: 1



Plant: 32411

Berlin

368 New Brooklyn Road
Berlin, NJ 08009
856-809-0142

3/3/2017 08:51

In :

Customer: 8638404 THE AMBIENT GROUP LLC

Order : 950949 Camden, NJ. ABC Barrel Project

P.O. :

Tkt. No. 1006027141



Product 114203

Bank Run

S.O. Info: Camden, NJ.

Ship Ref: 327 N. Front St

	Pounds	Kilo
Gross	77,680	35,235
Tare	27,360 *	12,410
Net	50,320	22,825

25.16 Ton 22.82

* Predetermined Tare

	UNIT	TOTALS
Material:		
Freight:		
Tax:		
Fee / Fuel:		
Other Chrg: <u>No</u>		

Today Tons:	126.13	Loads:
Tons To Date:	781.80	5
Today Tonnes	114.42	
Tonnes To Date:	709.24	

Carrier : 8040648 GJ SCOTT LLC

Vehicle: GS4 GS4

License: AJ118L

MaxGVW: 80,000

Received: _____

Weighmaster: Colleen LeSage

P/D Status: Deliver

Cust: _____

By acceptance of this ticket (with or without signature), driver accepts on behalf of themselves/their employer sole responsibility to ensure that the load received is within the weight limit authorized by law and shall hold seller harmless against any and all claims with respect to same
CURB DELIVERY ONLY. NOT RESPONSIBLE FOR ANY DAMAGE BEYOND CURB.

Customer Do Not Accept [1] Scale: 1



Plant: 32411

Berlin

368 New Brooklyn Road
Berlin, NJ 08009
856-809-0142

3/3/2017 08:54

In :

Customer: 8638404 THE AMBIENT GROUP LLC

Order : 950949 Camden, NJ. ABC Barrel Project

P.O. :

Tkt. No. 1006027142



Product 114203

Bank Run

S.O. Info: Camden, NJ.

Ship Ref: 327 N. Front St

	Pounds	Kilo
Gross	79,140	35,897
Tare	28,120 *	12,755
Net	51,020	23,142

25.51 Ton 23.14

* Predetermined Tare

	UNIT	TOTALS
Material:		
Freight:		
Tax:		
Fee / Fuel:		
Other Chrg: <u>No</u>		

Today Tons:	151.64	Loads:
Tons To Date:	807.31	6
Today Tonnes	137.57	
Tonnes To Date:	732.38	

Carrier : 8040648 GJ SCOTT LLC

Vehicle: GS17 GS17

License: AT640K

MaxGVW: 80,000

Received: _____

Weighmaster: Colleen LeSage

P/D Status: Deliver

Cust: _____

By acceptance of this ticket (with or without signature), driver accepts on behalf of themselves/their employer sole responsibility to ensure that the load received is within the weight limit authorized by law and shall hold seller harmless against any and all claims with respect to same
CURB DELIVERY ONLY. NOT RESPONSIBLE FOR ANY DAMAGE BEYOND CURB.

Customer Do Not Accept [1] Scale: 1



Plant: 32411

Berlin

368 New Brooklyn Road
Berlin, NJ 08009
856-809-0142

3/3/2017 10:27 In :
Customer: 8638404 THE AMBIENT GROUP LLC
Order : 950949 Camden, NJ. ABC Barrel Project
P.O. :

Tkt. No. 1006027144



Product 114203
Bank Run
S.O. Info: Camden, NJ.
Ship Ref: 327 N. Front St

	Pounds	Kilo
Gross	77,120	34,981
Tare	27,360 *	12,410
Net	49,760	22,571

24.88 Ton 22.57

* Predetermined Tare

	UNIT	TOTALS
Material:		
Freight:		
Tax:		
Fee / Fuel:		
Other Chrg:	No	

Today Tons:	176.52	Loads:
Tons To Date:	832.19	7
Today Tonnes	160.14	
Tonnes To Date:	754.95	

By acceptance of this ticket (with or without signature), driver accepts on behalf of themselves/their employer sole responsibility to ensure that the load received is within the weight limit authorized by law and shall hold seller harmless against any and all claims with respect to same CURB DELIVERY ONLY. NOT RESPONSIBLE FOR ANY DAMAGE BEYOND CURB.

Carrier : 8040648 GJ SCOTT LLC

Vehicle: GS4 GS4

License: AJ118L

MaxGVW: 80,000

Received: _____

Cust: _____

Weighmaster: Colleen LeSage

P/D Status: Deliver

Customer Copy

Scale: 1



Plant: 32411

Berlin

368 New Brooklyn Road
Berlin, NJ 08009
856-809-0142

3/3/2017 10:29 In :
Customer: 8638404 THE AMBIENT GROUP LLC
Order : 950949 Camden, NJ. ABC Barrel Project
P.O. :

Tkt. No. 1006027145



Product 114203
Bank Run
S.O. Info: Camden, NJ.
Ship Ref: 327 N. Front St

	Pounds	Kilo
Gross	77,820	35,299
Tare	28,120 *	12,755
Net	49,700	22,544

24.85 Ton 22.54

* Predetermined Tare

	UNIT	TOTALS
Material:		
Freight:		
Tax:		
Fee / Fuel:		
Other Chrg:	No	

Today Tons:	201.37	Loads:
Tons To Date:	857.04	8
Today Tonnes	182.68	
Tonnes To Date:	777.49	

By acceptance of this ticket (with or without signature), driver accepts on behalf of themselves/their employer sole responsibility to ensure that the load received is within the weight limit authorized by law and shall hold seller harmless against any and all claims with respect to same CURB DELIVERY ONLY. NOT RESPONSIBLE FOR ANY DAMAGE BEYOND CURB.

Carrier : 8040648 GJ SCOTT LLC

Vehicle: GS17 GS17

License: AT640K

MaxGVW: 80,000

Received: _____

Cust: _____

Weighmaster: Colleen LeSage

P/D Status: Deliver

Customer Do Not Accept [1]

Scale: 1



Plant: 32411

Berlin

368 New Brooklyn Road
Berlin, NJ 08009
856-809-0142

3/3/2017 12:02 In :
Customer: 8638404 THE AMBIENT GROUP LLC
Order : 950949 Camden, NJ. ABC Barrel Project
P.O. :

Tkt. No. 1006027148



Product 114203
Bank Run
S.O. Info: Camden, NJ.
Ship Ref: 327 N. Front St

	Pounds	Kilo
Gross	76,600	34,745
Tare	27,360 *	12,410
Net	49,240	22,335

24.62 Ton 22.33
* Predetermined Tare

	UNIT	TOTALS
Material:		
Freight:		
Tax:		
Fee / Fuel:		
Other Chrg: No		

Today Tons:	225.99	Loads:
Tons To Date:	881.66	9
Today Tonnes	205.01	
Tonnes To Date:	799.83	

Carrier : 8040648 GJ SCOTT LLC
Vehicle: GS4 GS4
License: AJ118L
MaxGVW: 80,000

By acceptance of this ticket (with or without signature), driver accepts on behalf of themselves/their employer sole responsibility to ensure that the load received is within the weight limit authorized by law and shall hold seller harmless against any and all claims with respect to same CURB DELIVERY ONLY. NOT RESPONSIBLE FOR ANY DAMAGE BEYOND CURB.

Received: _____
Weighmaster: Colleen LeSage

Cust: _____

P/D Status: Deliver

Customer Copy

Scale: 1



Plant: 32411

Berlin

368 New Brooklyn Road
Berlin, NJ 08009
856-809-0142

3/3/2017 12:04 In :
Customer: 8638404 THE AMBIENT GROUP LLC
Order : 950949 Camden, NJ. ABC Barrel Project
P.O. :

Tkt. No. 1006027149



Product 114203
Bank Run
S.O. Info: Camden, NJ.
Ship Ref: 327 N. Front St

	Pounds	Kilo
Gross	78,200	35,471
Tare	28,120 *	12,755
Net	50,080	22,716

25.04 Ton 22.72
* Predetermined Tare

	UNIT	TOTALS
Material:		
Freight:		
Tax:		
Fee / Fuel:		
Other Chrg: No		

Today Tons:	251.03	Loads:
Tons To Date:	906.70	10
Today Tonnes	227.73	
Tonnes To Date:	822.54	

Carrier : 8040648 GJ SCOTT LLC
Vehicle: GS17 GS17
License: AT640K
MaxGVW: 80,000

By acceptance of this ticket (with or without signature), driver accepts on behalf of themselves/their employer sole responsibility to ensure that the load received is within the weight limit authorized by law and shall hold seller harmless against any and all claims with respect to same CURB DELIVERY ONLY. NOT RESPONSIBLE FOR ANY DAMAGE BEYOND CURB.

Received: _____
Weighmaster: Colleen LeSage

Cust: _____

P/D Status: Deliver

Customer Copy

Scale: 1



Plant: 32411

Berlin

368 New Brooklyn Road
Berlin, NJ 08009
856-809-0142

3/6/2017 07:19 In: 6:50:57
Customer: 8638404 THE AMBIENT GROUP LLC
Order: 950949 Camden, NJ. ABC Barrel Project
P.O.:

Tkt. No. 1006027153



Product 114203
Bank Run
S.O. Info: Camden, NJ.
Ship Ref: 327 N. Front St

	Pounds	Kilo
Gross	78,280	35,507
Tare	28,660	13,000
Net	49,620	22,507
	24.81 Ton	22.51

	UNIT	TOTALS
Material:		
Freight:		
Tax:		
Fee / Fuel:		
Other Chrg:	No	

Today Tons:	24.81	Loads:
Tons To Date:	931.51	1
Today Tonnes	22.51	
Tonnes To Date:	845.05	

Carrier: 8040648 GJ SCOTT LLC
Vehicle: GS15 GS15
License: AS672T
MaxGVW: 80,000
Received: *ca*
Weighmaster: Colleen LeSage

By acceptance of this ticket (with or without signature), driver accepts on behalf of themselves/their employer sole responsibility to ensure that the load received is within the weight limit authorized by law and shall hold seller harmless against any and all claims with respect to same CURB DELIVERY ONLY. NOT RESPONSIBLE FOR ANY DAMAGE BEYOND CURB.

Cust: _____

P/D Status: Deliver

Customer Copy

Scale: 1



Plant: 32411

Berlin

368 New Brooklyn Road
Berlin, NJ 08009
856-809-0142

3/6/2017 07:21 In: 6:54:09
Customer: 8638404 THE AMBIENT GROUP LLC
Order: 950949 Camden, NJ. ABC Barrel Project
P.O.:

Tkt. No. 1006027154



Product 114203
Bank Run
S.O. Info: Camden, NJ.
Ship Ref: 327 N. Front St

	Pounds	Kilo
Gross	77,180	35,008
Tare	28,000	12,701
Net	49,180	22,308
	24.59 Ton	22.31

	UNIT	TOTALS
Material:		
Freight:		
Tax:		
Fee / Fuel:		
Other Chrg:	No	

Today Tons:	49.40	Loads:
Tons To Date:	956.10	2
Today Tonnes	44.81	
Tonnes To Date:	867.36	

Carrier: 8040648 GJ SCOTT LLC
Vehicle: GS16 GS16
License: AT639K
MaxGVW: 80,000
Received: *[Signature]*
Weighmaster: Colleen LeSage

By acceptance of this ticket (with or without signature), driver accepts on behalf of themselves/their employer sole responsibility to ensure that the load received is within the weight limit authorized by law and shall hold seller harmless against any and all claims with respect to same CURB DELIVERY ONLY. NOT RESPONSIBLE FOR ANY DAMAGE BEYOND CURB.

Cust: _____

P/D Status: Deliver

Customer Copy

Scale: 1



Plant: 32411

Berlin
368 New Brooklyn Road
Berlin, NJ 08009
856-809-0142

3/6/2017 07:24 In: 6:55:37
Customer: 8638404 THE AMBIENT GROUP LLC
Order : 950949 Camden, NJ. ABC Barrel Project
P.O. :

Tkt. No. 1006027155

Product 114203
Bank Run
S.O. Info: Camden, NJ.
Ship Ref: 327 N. Front St



	Pounds	Kilo
Gross	77,640	35,217
Tare	28,720	13,027
Net	48,920	22,190
	24.46 Ton	22.19

	UNIT	TOTALS
Material:		
Freight:		
Tax:		
Fee / Fuel:		
Other Chrg: No		

Today Tons:	73.86	Loads:
Tons To Date:	980.56	3
Today Tonnes	67.00	
Tonnes To Date:	889.55	

Carrier : 8040648 GJ SCOTT LLC
Vehicle: GS14 GS14
License: As672T
MaxGVW: 80,000
Received:
Weighmaster: Colleen LeSage

By acceptance of this ticket (with or without signature), driver accepts on behalf of themselves/their employer sole responsibility to ensure that the load received is within the weight limit authorized by law and shall hold seller harmless against any and all claims with respect to same
CURB DELIVERY ONLY. NOT RESPONSIBLE FOR ANY DAMAGE BEYOND CURB.

Cust: _____

P/D Status: Deliver

Customer Do Not Accept [1] Scale: 1



Plant: 32411

Berlin
368 New Brooklyn Road
Berlin, NJ 08009
856-809-0142

3/6/2017 07:26 In: 6:40:43
Customer: 8638404 THE AMBIENT GROUP LLC
Order : 950949 Camden, NJ. ABC Barrel Project
P.O. :

Tkt. No. 1006027156

Product 114203
Bank Run
S.O. Info: Camden, NJ.
Ship Ref: 327 N. Front St



	Pounds	Kilo
Gross	79,320	35,979
Tare	24,640	11,177
Net	54,680	24,802
	27.34 Ton	24.80

	UNIT	TOTALS
Material:		
Freight:		
Tax:		
Fee / Fuel:		
Other Chrg: No		

Today Tons:	101.20	Loads:
Tons To Date:	1,007.90	4
Today Tonnes	91.81	
Tonnes To Date:	914.35	

Carrier : 2346970 GEORGE LAZOS TRUCKING
Vehicle: LG004 AP213T
License: LG004
MaxGVW: 80,000
Received:
Weighmaster: Colleen LeSage

By acceptance of this ticket (with or without signature), driver accepts on behalf of themselves/their employer sole responsibility to ensure that the load received is within the weight limit authorized by law and shall hold seller harmless against any and all claims with respect to same
CURB DELIVERY ONLY. NOT RESPONSIBLE FOR ANY DAMAGE BEYOND CURB.

Cust: _____

P/D Status: Deliver

Customer Copy Scale: 1



Plant: 32411

Berlin
368 New Brooklyn Road
Berlin, NJ 08009
856-809-0142, -

3/6/2017 09:05 In:
Customer: 8638404 THE AMBIENT GROUP LLC
Order : 950949 Camden, NJ. ABC Barrel Project
P.O. :

Tkt. No. 1006027164



Product 114203
Bank Run
S.O. Info: Camden, NJ.
Ship Ref: 327 N. Front St

	Pounds	Kilo
Gross	78.660	35.680
Tare	28.660 *	13.000
Net	50.000	22.680

25.00 Ton 22.68

* Predetermined Tare

UNIT	TOTALS
Material:	
Freight:	
Tax:	
Fee / Fuel:	
Other Chrg: No	

Today Tons:	126.20	Loads:
Tons To Date:	1,032.90	5
Today Tonnes	114.49	
Tonnes To Date:	937.03	

Carrier : 8040648 GJ SCOTT LLC
Vehicle: GS15 GS15
License: AS672T
MaxGVW: 80,000

By acceptance of this ticket (with or without signature), driver accepts on behalf of themselves/their employer sole responsibility to ensure that the load received is within the weight limit authorized by law and shall hold seller harmless against any and all claims with respect to same CURB DELIVERY ONLY. NOT RESPONSIBLE FOR ANY DAMAGE BEYOND CURB.

Received: 
Weighmaster: Colleen LeSage

Cust: _____

P/D Status: Deliver

Customer Do Not Accept [2] Scale: 1



Plant: 32411

Berlin
368 New Brooklyn Road
Berlin, NJ 08009
856-809-0142, -

3/6/2017 09:07 In:
Customer: 8638404 THE AMBIENT GROUP LLC
Order : 950949 Camden, NJ. ABC Barrel Project
P.O. :

Tkt. No. 1006027165



Product 114203
Bank Run
S.O. Info: Camden, NJ.
Ship Ref: 327 N. Front St

	Pounds	Kilo
Gross	78.580	35.643
Tare	28.000 *	12.701
Net	50.580	22.943

25.29 Ton 22.94

* Predetermined Tare

UNIT	TOTALS
Material:	
Freight:	
Tax:	
Fee / Fuel:	
Other Chrg: No	

Today Tons:	151.49	Loads:
Tons To Date:	1,058.19	6
Today Tonnes	137.43	
Tonnes To Date:	959.97	

Carrier : 8040648 GJ SCOTT LLC
Vehicle: GS16 GS16
License: AT639K
MaxGVW: 80,000

By acceptance of this ticket (with or without signature), driver accepts on behalf of themselves/their employer sole responsibility to ensure that the load received is within the weight limit authorized by law and shall hold seller harmless against any and all claims with respect to same CURB DELIVERY ONLY. NOT RESPONSIBLE FOR ANY DAMAGE BEYOND CURB.

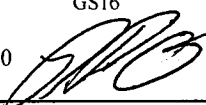
Received: 
Weighmaster: Colleen LeSage

Cust: _____

P/D Status: Deliver

Customer Copy Scale: 1



Plant: 32411

Berlin

368 New Brooklyn Road
Berlin, NJ 08009
856-809-0142

3/6/2017 09:09

In :

Customer: 8638404 THE AMBIENT GROUP LLC

Order : 950949 Camden, NJ. ABC Barrel Project

P.O. :

Tkt. No. 1006027166

Product 114203

Bank Run

S.O. Info: Camden, NJ.

Ship Ref: 327 N. Front St



	Pounds	Kilo
Gross	78,760	35,725
Tare	28,720 *	13,027
Net	50,040	22,698

25.02 Ton 22.70

* Predetermined Tare

Today Tons:	176.51	Loads:
Tons To Date:	1,083.21	7
Today Tonnes	160.13	
Tonnes To Date:	982.67	

	UNIT	TOTALS
Material:		
Freight:		
Tax:		
Fee / Fuel:		
Other Chrg: No		

By acceptance of this ticket (with or without signature), driver accepts on behalf of themselves/their employer sole responsibility to ensure that the load received is within the weight limit authorized by law and shall hold seller harmless against any and all claims with respect to same CURB DELIVERY ONLY. NOT RESPONSIBLE FOR ANY DAMAGE BEYOND CURB.

Carrier : 8040648 GJ SCOTT LLC

Vehicle: GS14 GS14

License: As672T

MaxGVW: 80,000

Received:

Weighmaster: Colleen LeSage

Cust: _____

P/D Status: Deliver

Customer Do Not Accept [1] Scale: 1



Plant: 32411

Berlin

368 New Brooklyn Road
Berlin, NJ 08009
856-809-0142

3/6/2017 09:22

In :

Customer: 8638404 THE AMBIENT GROUP LLC

Order : 950949 Camden, NJ. ABC Barrel Project

P.O. :

Tkt. No. 1006027170

Product 114203

Bank Run

S.O. Info: Camden, NJ.

Ship Ref: 327 N. Front St



	Pounds	Kilo
Gross	76,800	34,836
Tare	24,640 *	11,177
Net	52,160	23,659

26.08 Ton 23.66

* Predetermined Tare

Today Tons:	202.59	Loads:
Tons To Date:	1,109.29	8
Today Tonnes	183.79	
Tonnes To Date:	1,006.33	

	UNIT	TOTALS
Material:		
Freight:		
Tax:		
Fee / Fuel:		
Other Chrg: No		

By acceptance of this ticket (with or without signature), driver accepts on behalf of themselves/their employer sole responsibility to ensure that the load received is within the weight limit authorized by law and shall hold seller harmless against any and all claims with respect to same CURB DELIVERY ONLY. NOT RESPONSIBLE FOR ANY DAMAGE BEYOND CURB.

Carrier : 2346970 GEORGE LAZOS TRUCKING

Vehicle: LG004 AP213T

License: LG004

MaxGVW: 80,000

Received:

Weighmaster: Colleen LeSage

Cust: _____

P/D Status: Deliver

Customer Copy Scale: 1



Plant: 32411

Berlin

368 New Brooklyn Road
Berlin, NJ 08009
856-809-0142

3/6/2017 10:40 In :
Customer: 8638404 THE AMBIENT GROUP LLC
Order : 950949 Camden, NJ. ABC Barrel Project
P.O. :

Tkt. No. 1006027176



Product 114203
Bank Run
S.O. Info: Camden, NJ.
Ship Ref: 327 N. Front St

	Pounds	Kilo
Gross	78,860	35,770
Tare	28,720 *	13,027
Net	50,140	22,743

25.07 Ton 22.74
* Predetermined Tare

	UNIT	TOTALS
Material:		
Freight:		
Tax:		
Fee / Fuel:		
Other Chrg: No		

Today Tons:	227.66	Loads:
Tons To Date:	1,134.36	9
Today Tonnes	206.53	
Tonnes To Date:	1,029.07	

By acceptance of this ticket (with or without signature), driver accepts on behalf of themselves/their employer sole responsibility to ensure that the load received is within the weight limit authorized by law and shall hold seller harmless against any and all claims with respect to same CURB DELIVERY ONLY. NOT RESPONSIBLE FOR ANY DAMAGE BEYOND CURB.

Carrier : 8040648 GJ SCOTT LLC
Vehicle: GS14 GS14
License: As672T
MaxGVW: 80,000
Received:

Cust: _____

P/D Status: Deliver

Customer Copy

Scale: 1



Plant: 32411

Berlin

368 New Brooklyn Road
Berlin, NJ 08009
856-809-0142

3/6/2017 10:47 In :
Customer: 8638404 THE AMBIENT GROUP LLC
Order : 950949 Camden, NJ. ABC Barrel Project
P.O. :

Tkt. No. 1006027177



Product 114203
Bank Run
S.O. Info: Camden, NJ.
Ship Ref: 327 N. Front St

	Pounds	Kilo
Gross	76,680	34,781
Tare	24,640 *	11,177
Net	52,040	23,605

26.02 Ton 23.60
* Predetermined Tare

	UNIT	TOTALS
Material:		
Freight:		
Tax:		
Fee / Fuel:		
Other Chrg: No		

Today Tons:	253.68	Loads:
Tons To Date:	1,160.38	10
Today Tonnes	230.13	
Tonnes To Date:	1,052.68	

By acceptance of this ticket (with or without signature), driver accepts on behalf of themselves/their employer sole responsibility to ensure that the load received is within the weight limit authorized by law and shall hold seller harmless against any and all claims with respect to same CURB DELIVERY ONLY. NOT RESPONSIBLE FOR ANY DAMAGE BEYOND CURB.

Carrier : 2346970 GEORGE LAZOS TRUCKING
Vehicle: LG004 AP213T
License: LG004
MaxGVW: 80,000
Received:

Cust: _____

P/D Status: Deliver

Customer Copy

Scale: 1



Plant: 32411

Berlin

368 New Brooklyn Road
Berlin, NJ 08009
856-809-0142

3/6/2017 10:50

In :

Customer: 8638404 THE AMBIENT GROUP LLC

Order : 950949 Camden, NJ. ABC Barrel Project

P.O. :

Tkt. No. 1006027178

Product 114203



Bank Run

S.O. Info: Camden, NJ.

Ship Ref: 327 N. Front St

	Pounds	Kilo
Gross	78,040	35,398
Tare	28,000 *	12,701
Net	50,040	22,698

25.02 Ton 22.70

* Predetermined Tare

	UNIT	TOTALS
Material:		
Freight:		
Tax:		
Fee / Fuel:		
Other Chrg: No		

Today Tons:	278.70	Loads:
Tons To Date:	1,185.40	11
Today Tonnes	252.83	
Tonnes To Date:	1,075.38	

By acceptance of this ticket (with or without signature), driver accepts on behalf of themselves/their employer sole responsibility to ensure that the load received is within the weight limit authorized by law and shall hold seller harmless against any and all claims with respect to same
CURB DELIVERY ONLY. NOT RESPONSIBLE FOR ANY DAMAGE BEYOND CURB.

Carrier : 8040648 GJ SCOTT LLC

Vehicle: GS16 GS16

License: AT639K

MaxGVW: 80,000

Received:

Cust: _____

Weighmaster: Colleen LeSage

P/D Status: Deliver

Customer Do Not Accept [1] Scale: 1



Plant: 32411

Berlin

368 New Brooklyn Road
Berlin, NJ 08009
856-809-0142

3/6/2017 11:56

In :

Customer: 8638404 THE AMBIENT GROUP LLC

Order : 950949 Camden, NJ. ABC Barrel Project

P.O. :

Tkt. No. 1006027180

Product 114203



Bank Run

S.O. Info: Camden, NJ.

Ship Ref: 327 N. Front St

	Pounds	Kilo
Gross	78,120	35,435
Tare	28,720 *	13,027
Net	49,400	22,407

24.70 Ton 22.41

* Predetermined Tare

	UNIT	TOTALS
Material:		
Freight:		
Tax:		
Fee / Fuel:		
Other Chrg: No		

Today Tons:	303.40	Loads:
Tons To Date:	1,210.10	12
Today Tonnes	275.24	
Tonnes To Date:	1,097.78	

By acceptance of this ticket (with or without signature), driver accepts on behalf of themselves/their employer sole responsibility to ensure that the load received is within the weight limit authorized by law and shall hold seller harmless against any and all claims with respect to same
CURB DELIVERY ONLY. NOT RESPONSIBLE FOR ANY DAMAGE BEYOND CURB.

Carrier : 8040648 GJ SCOTT LLC

Vehicle: GS14 GS14

License: As6721

MaxGVW: 80,000

Received:

Cust: _____

Weighmaster: Colleen LeSage

P/D Status: Deliver

Customer Do Not Accept [1] Scale: 1



Plant: 32411

Berlin

368 New Brooklyn Road
Berlin, NJ 08009
856-809-0142

3/6/2017 12:15 In :
Customer: 8638404 THE AMBIENT GROUP LLC
Order : 950949 Camden, NJ. ABC Barrel Project
P.O. :

Tkt. No. 1006027183



Product 114203
Bank Run
S.O. Info: Camden, NJ.
Ship Ref: 327 N. Front St

	Pounds	Kilo
Gross	77,300	35,063
Tare	24,640 *	11,177
Net	52,660	23,886

26.33 Ton 23.89

* Predetermined Tare

	UNIT	TOTALS
Material:		
Freight:		
Tax:		
Fee / Fuel:		
Other Chrg: No		

Today Tons:	329.73	Loads:
Tons To Date:	1,236.43	13
Today Tonnes	299.13	
Tonnes To Date:	1,121.67	

Carrier : 2346970 GEORGE LAZOS TRUCKING
Vehicle: LG004 AP213T
License: LG004
MaxGVW: 80,000

By acceptance of this ticket (with or without signature), driver accepts on behalf of themselves/their employer sole responsibility to ensure that the load received is within the weight limit authorized by law and shall hold seller harmless against any and all claims with respect to same CURB DELIVERY ONLY. NOT RESPONSIBLE FOR ANY DAMAGE BEYOND CURB.

Received: _____
Weighmaster: Colleen LeSage

Cust: _____

P/D Status: Deliver

Customer Copy

Scale: 1



Plant: 32411

Berlin

368 New Brooklyn Road
Berlin, NJ 08009
856-809-0142

3/6/2017 12:17 In :
Customer: 8638404 THE AMBIENT GROUP LLC
Order : 950949 Camden, NJ. ABC Barrel Project
P.O. :

Tkt. No. 1006027184



Product 114203
Bank Run
S.O. Info: Camden, NJ.
Ship Ref: 327 N. Front St

	Pounds	Kilo
Gross	78,600	35,652
Tare	28,000 *	12,701
Net	50,600	22,952

25.30 Ton 22.95

* Predetermined Tare

	UNIT	TOTALS
Material:		
Freight:		
Tax:		
Fee / Fuel:		
Other Chrg: No		

Today Tons:	355.03	Loads:
Tons To Date:	1,261.73	14
Today Tonnes	322.08	
Tonnes To Date:	1,144.62	

Carrier : 8040648 GJ SCOTT LLC
Vehicle: GS16 GS16
License: AT639K
MaxGVW: 80,000

By acceptance of this ticket (with or without signature), driver accepts on behalf of themselves/their employer sole responsibility to ensure that the load received is within the weight limit authorized by law and shall hold seller harmless against any and all claims with respect to same CURB DELIVERY ONLY. NOT RESPONSIBLE FOR ANY DAMAGE BEYOND CURB.

Received: _____
Weighmaster: Colleen LeSage

Cust: _____

P/D Status: Deliver

Customer Do Not Accept [2]

Scale: 1



Plant: 32411

Berlin

368 New Brooklyn Road
Berlin, NJ 08009
856-809-0142

3/6/2017 13:34 In :
Customer: 8638404 THE AMBIENT GROUP LLC
Order : 950949 Camden, NJ. ABC Barrel Project
P.O. :

Tkt. No. 1006027193



Product 114203
Bank Run
S.O. Info: Camden, NJ.
Ship Ref: 327 N. Front St

	Pounds	Kilo
Gross	79,980	36,278
Tare	24,640 *	11,177
Net	55,340	25,102

27.67 Ton 25.10

* Predetermined Tare

	UNIT	TOTALS
Material:		
Freight:		
Tax:		
Fee / Fuel:		
Other Chrg:	No	

Today Tons:	407.91	Loads:
Tons To Date:	1,314.61	16
Today Tonnes	370.05	
Tonnes To Date:	1,192.59	

Carrier : 2346970 GEORGE LAZOS TRUCKING
Vehicle: LG004 AP213T
License: LG004
MaxGVW: 80,000

By acceptance of this ticket (with or without signature), driver accepts on behalf of themselves/their employer sole responsibility to ensure that the load received is within the weight limit authorized by law and shall hold self harmless against any and all claims with respect to same CURB DELIVERY ONLY. NOT RESPONSIBLE FOR ANY DAMAGE BEYOND CURB.

Received: _____
Weighmaster: Colleen LeSage

Cust: _____

P/D Status: Deliver

Customer Copy

Scale: 1



Plant: 32411

Berlin
368 New Brooklyn Road
Berlin, NJ 08009
856-809-0142

3/6/2017 13:18 In :
Customer: 8638404 THE AMBIENT GROUP LLC
Order : 950949 Camden, NJ. ABC Barrel Project
P.O. :

Tkt. No. 1006027190



Product 114203
Bank Run
S.O. Info: Camden, NJ.
Ship Ref: 327 N. Front St

	Pounds	Kilo
Gross	79,140	35,897
Tare	28,720 *	13,027
Net	50,420	22,870
	25.21 Ton	22.87

* Predetermined Tare

	UNIT	TOTALS
Material:		
Freight:		
Tax:		
Fee / Fuel:		
Other Chrg: No		

Today Tons:	380.24	Loads:
Tons To Date:	1,286.94	15
Today Tonnes	344.95	
Tonnes To Date:	1,167.49	

Carrier : 8040648 GJ SCOTT LLC
Vehicle: GS14 GS14
License: As672T
MaxGVW: 39,000
Received:
Weighmaster: Colleen LeSage

By acceptance of this ticket (with or without signature), driver accepts on behalf of themselves/their employer sole responsibility to ensure that the load received is within the weight limit authorized by law and shall hold seller harmless against any and all claims with respect to same CURB DELIVERY ONLY. NOT RESPONSIBLE FOR ANY DAMAGE BEYOND CURB.

Cust: _____

P/D Status: Deliver

Customer Do Not Accept [2] Scale: 1



Plant: 32411

Berlin
368 New Brooklyn Road
Berlin, NJ 08009
856-809-0142

3/6/2017 13:53 In :
Customer: 8638404 THE AMBIENT GROUP LLC
Order : 950949 Camden, NJ. ABC Barrel Project
P.O. :

Tkt. No. 1006027195



Product 114203
Bank Run
S.O. Info: Camden, NJ.
Ship Ref: 327 N. Front St

	Pounds	Kilo
Gross	79,680	36,142
Tare	28,000 *	12,701
Net	51,680	23,442
	25.84 Ton	23.44

* Predetermined Tare

	UNIT	TOTALS
Material:		
Freight:		
Tax:		
Fee / Fuel:		
Other Chrg: No		

Today Tons:	433.75	Loads:
Tons To Date:	1,340.45	17
Today Tonnes	393.49	
Tonnes To Date:	1,216.04	

Carrier : 8040648 GJ SCOTT LLC
Vehicle: GS16 GS16
License: AT639K
MaxGVW: 80,000
Received:
Weighmaster: Colleen LeSage

By acceptance of this ticket (with or without signature), driver accepts on behalf of themselves/their employer sole responsibility to ensure that the load received is within the weight limit authorized by law and shall hold seller harmless against any and all claims with respect to same CURB DELIVERY ONLY. NOT RESPONSIBLE FOR ANY DAMAGE BEYOND CURB.

Cust: _____

P/D Status: Deliver

Customer Do Not Accept [2] Scale: 1



Plant: 32411

Berlin

368 New Brooklyn Road
Berlin, NJ 08009
856-809-0142, -

3/7/2017 07:20 In: 6:38:29
Customer: 8638404 THE AMBIENT GROUP LLC
Order: 950949 Camden, NJ. ABC Barrel Project
P.O.:

Tkt. No. 1006027204

Product 114203
Bank Run
S.O. Info: Camden, NJ.
Ship Ref: 327 N. Front St



	Pounds	Kilo
Gross	77,660	35,226
Tare	27,840	12,628
Net	49,820	22,598
24.91 Ton		22.60

Material:	UNIT	TOTALS
Material:		
Freight:		
Tax:		
Fee / Fuel:		
Other Chrg: No		

Today Tons:	24.91	Loads:
Tons To Date:	1,365.36	1
Today Tonnes	22.60	
Tonnes To Date:	1,238.63	

Carrier: 9249110 CLM CONTRACTING LLC
Vehicle: CLM6 CLM6
License: AT597T
MaxGVW: 80,000

By acceptance of this ticket (with or without signature), driver accepts on behalf of themselves/their employer sole responsibility to ensure that the load received is within the weight limit authorized by law and shall hold seller harmless against any and all claims with respect to same
CURB DELIVERY ONLY. NOT RESPONSIBLE FOR ANY DAMAGE BEYOND CURB.

Received: _____ Cust: _____
Weighmaster: Colleen LeSage

P/D Status: Deliver

Customer Do Not Accept [2] Scale: 1



Plant: 32411

Berlin

368 New Brooklyn Road
Berlin, NJ 08009
856-809-0142,

3/7/2017 07:47 In: 7:26:45
Customer: 8638404 THE AMBIENT GROUP LLC
Order: 950949 Camden, NJ. ABC Barrel Project
P.O.:

Tkt. No. 1006027207

Product 114203
Bank Run
S.O. Info: Camden, NJ.
Ship Ref: 327 N. Front St



	Pounds	Kilo
Gross	78,140	35,444
Tare	28,680	13,009
Net	49,460	22,435
24.73 Ton		22.43

Material:	UNIT	TOTALS
Material:		
Freight:		
Tax:		
Fee / Fuel:		
Other Chrg: No		

Today Tons:	49.64	Loads:
Tons To Date:	1,390.09	2
Today Tonnes	45.03	
Tonnes To Date:	1,261.07	

Carrier: 8040648 GJ SCOTT LLC
Vehicle: GS14 GS14
License: As672T
MaxGVW: 80,000

By acceptance of this ticket (with or without signature), driver accepts on behalf of themselves/their employer sole responsibility to ensure that the load received is within the weight limit authorized by law and shall hold seller harmless against any and all claims with respect to same
CURB DELIVERY ONLY. NOT RESPONSIBLE FOR ANY DAMAGE BEYOND CURB.

Received: _____ Cust: _____
Weighmaster: Colleen LeSage

P/D Status: Deliver

Customer Do Not Accept [1] Scale: 1



Plant: 32411

Berlin

368 New Brooklyn Road
Berlin, NJ 08009
856-809-0142

3/7/2017 07:49 In: 7:27:09
Customer: 8638404 THE AMBIENT GROUP LLC
Order: 950949 Camden, NJ. ABC Barrel Project
P.O.:

Tkt. No. 1006027208

Product 114203
Bank Run
S.O. Info: Camden, NJ.
Ship Ref: 327 N. Front St



	Pounds	Kilo
Gross	77,420	35,117
Tare	28,120	12,755
Net	49,300	22,362
	24.65 Ton	22.36

	UNIT	TOTALS
Material:		
Freight:		
Tax:		
Fee / Fuel:		
Other Chrg: No		

Today Tons:	74.29	Loads:
Tons To Date:	1,414.74	3
Today Tonnes	67.39	
Tonnes To Date:	1,283.43	

Carrier: 8040648 GJ SCOTT LLC
Vehicle: GS16 GS16
License: AT639K
MaxGVW: 80,000
Received:
Weighmaster: Colleen LeSage

By acceptance of this ticket (with or without signature), driver accepts on behalf of themselves/their employer sole responsibility to ensure that the load received is within the weight limit authorized by law and shall hold seller harmless against any and all claims with respect to same CURB DELIVERY ONLY. NOT RESPONSIBLE FOR ANY DAMAGE BEYOND CURB.

Cust: _____

P/D Status: Deliver

Customer Do Not Accept [2] Scale: 1



Plant: 32411

Berlin

368 New Brooklyn Road
Berlin, NJ 08009
856-809-0142

3/7/2017 09:19 In: 9:07:35
Customer: 8638404 THE AMBIENT GROUP LLC
Order: 950949 Camden, NJ. ABC Barrel Project
P.O.:

Tkt. No. 1006027214

Product 114203
Bank Run
S.O. Info: Camden, NJ.
Ship Ref: 327 N. Front St



	Pounds	Kilo
Gross	74,520	33,802
Tare	25,340	11,494
Net	49,180	22,308
	24.59 Ton	22.31

	UNIT	TOTALS
Material:		
Freight:		
Tax:		
Fee / Fuel:		
Other Chrg: No		

Today Tons:	98.88	Loads:
Tons To Date:	1,439.33	4
Today Tonnes	89.70	
Tonnes To Date:	1,305.74	

Carrier: 2347198 RAIO CONTRACTING & MATE
Vehicle: RO230 RAIO
License: ALS813U
MaxGVW: 86,000
Received:
Weighmaster: Colleen LeSage

By acceptance of this ticket (with or without signature), driver accepts on behalf of themselves/their employer sole responsibility to ensure that the load received is within the weight limit authorized by law and shall hold seller harmless against any and all claims with respect to same CURB DELIVERY ONLY. NOT RESPONSIBLE FOR ANY DAMAGE BEYOND CURB.

Cust: _____

P/D Status: Deliver

Customer Do Not Accept [3] Scale: 1



Plant: 32411

Berlin
368 New Brooklyn Road
Berlin, NJ 08009
856-809-0142

3/7/2017 09:21 In: 9:07:09
Customer: 8638404 THE AMBIENT GROUP LLC
Order: 950949 Camden, NJ. ABC Barrel Project
P.O.:

Tkt. No. 1006027215



Product 114203
Bank Run
S.O. Info: Camden, NJ.
Ship Ref: 327 N. Front St

	Pounds	Kilo
Gross	73,260	33,230
Tare	25,480	11,558
Net	47,780	21,673
	23.89 Ton	21.67

	UNIT	TOTALS
Material:		
Freight:		
Tax:		
Fee / Fuel:		
Other Chrg: No		

Today Tons:	122.77	Loads:
Tons To Date:	1,463.22	5
Today Tonnes	111.38	
Tonnes To Date:	1,327.41	

By acceptance of this ticket (with or without signature), driver accepts on behalf of themselves/their employer sole responsibility to ensure that the load received is within the weight limit authorized by law and shall hold seller harmless against any and all claims with respect to same
CURB DELIVERY ONLY. NOT RESPONSIBLE FOR ANY DAMAGE BEYOND CURB.

Carrier: 2347198 RAO CONTRACTING & MATE
Vehicle: RO229 RAO
License: AS812U
MaxGVW: 80,000
Received: _____
Weighmaster: Colleen LeSage
P/D Status: Deliver

Cust: _____
 Customer Do Not Accept [2] Scale: 1



Plant: 32411

Berlin
368 New Brooklyn Road
Berlin, NJ 08009
856-809-0142

3/7/2017 09:22 In:
Customer: 8638404 THE AMBIENT GROUP LLC
Order: 950949 Camden, NJ. ABC Barrel Project
P.O.:

Tkt. No. 1006027216



Product 114203
Bank Run
S.O. Info: Camden, NJ.
Ship Ref: 327 N. Front St

	Pounds	Kilo
Gross	79,560	36,088
Tare	27,840 *	12,628
Net	51,720	23,460
	25.86 Ton	23.46

	UNIT	TOTALS
Material:		
Freight:		
Tax:		
Fee / Fuel:		
Other Chrg: No		

Today Tons:	148.63	Loads:
Tons To Date:	1,489.08	6
Today Tonnes	134.83	
Tonnes To Date:	1,350.87	

By acceptance of this ticket (with or without signature), driver accepts on behalf of themselves/their employer sole responsibility to ensure that the load received is within the weight limit authorized by law and shall hold seller harmless against any and all claims with respect to same
CURB DELIVERY ONLY. NOT RESPONSIBLE FOR ANY DAMAGE BEYOND CURB.

Carrier: 9249110 CLM CONTRACTING LLC
Vehicle: CLM6 CLM6
License: AT597T
MaxGVW: 80,000
Received: _____
Weighmaster: Colleen LeSage
P/D Status: Deliver

Cust: _____
 Customer Do Not Accept [2] Scale: 1



Plant: 32411

Berlin
368 New Brooklyn Road
Berlin, NJ 08009
856-809-0142

3/7/2017 09:25 In :
Customer: 8638404 THE AMBIENT GROUP LLC
Order : 950949 Camden, NJ. ABC Barrel Project
P.O. :

Tkt. No. 1006027217

Product 114203
Bank Run
S.O. Info: Camden, NJ.
Ship Ref: 327 N. Front St



	Pounds	Kilo
Gross	76,700	34,791
Tare	28,680 *	13,009
Net	48,020	21,782

24.01 Ton 21.78

* Predetermined Tare

	UNIT	TOTALS
Material:		
Freight:		
Tax:		
Fee / Fuel:		
Other Chrg: No		

Today Tons:	172.64	Loads:
Tons To Date:	1,513.09	7
Today Tonnes	156.62	
Tonnes To Date:	1,372.65	

Carrier : 8040648 GJ SCOTT LLC
Vehicle: GS14 GS14
License: As672T
MaxGVW: 80,000

By acceptance of this ticket (with or without signature), driver accepts on behalf of themselves/their employer sole responsibility to ensure that the load received is within the weight limit authorized by law and shall hold seller harmless against any and all claims with respect to same CURB DELIVERY ONLY. NOT RESPONSIBLE FOR ANY DAMAGE BEYOND CURB.

Received: _____ Cust: _____
Weighmaster: Colleen LeSage

P/D Status: Deliver

Customer Do Not Accept [2] Scale: 1



Plant: 32411

Berlin
368 New Brooklyn Road
Berlin, NJ 08009
856-809-0142

3/7/2017 09:26 In :
Customer: 8638404 THE AMBIENT GROUP LLC
Order : 950949 Camden, NJ. ABC Barrel Project
P.O. :

Tkt. No. 1006027218

Product 114203
Bank Run
S.O. Info: Camden, NJ.
Ship Ref: 327 N. Front St



	Pounds	Kilo
Gross	76,420	34,664
Tare	28,120 *	12,755
Net	48,300	21,909

24.15 Ton 21.91

* Predetermined Tare

	UNIT	TOTALS
Material:		
Freight:		
Tax:		
Fee / Fuel:		
Other Chrg: No		

Today Tons:	196.79	Loads:
Tons To Date:	1,537.24	8
Today Tonnes	178.52	
Tonnes To Date:	1,394.56	

Carrier : 8040648 GJ SCOTT LLC
Vehicle: GS16 GS16
License: AT639K
MaxGVW: 80,000

By acceptance of this ticket (with or without signature), driver accepts on behalf of themselves/their employer sole responsibility to ensure that the load received is within the weight limit authorized by law and shall hold seller harmless against any and all claims with respect to same CURB DELIVERY ONLY. NOT RESPONSIBLE FOR ANY DAMAGE BEYOND CURB.

Received: _____ Cust: _____
Weighmaster: Colleen LeSage

P/D Status: Deliver

Customer Do Not Accept [1] Scale: 1



Plant: 32411

Berlin
368 New Brooklyn Road
Berlin, NJ 08009
856-809-0142

3/7/2017 10:00 In: 9:43:01
Customer: 8638404 THE AMBIENT GROUP LLC
Order: 950949 Camden, NJ. ABC Barrel Project
P.O.:

Tkt. No. 1006027220



Product 114203
Bank Run
S.O. Info: Camden, NJ.
Ship Ref: 327 N. Front St

	Pounds	Kilo
Gross	73,660	33,412
Tare	25,460	11,548
Net	48,200	21,863
	24.10 Ton	21.86

	UNIT	TOTALS
Material:		
Freight:		
Tax:		
Fee / Fuel:		
Other Chrg: No		

Today Tons:	220.89	Loads:
Tons To Date:	1,561.34	9
Today Tonnes	200.39	
Tonnes To Date:	1,416.42	

Carrier: 2347198 RAIO CONTRACTING & MATE
Vehicle: RO223 Raio
License: AM608Y
MaxGVW: 80,000

By acceptance of this ticket (with or without signature), driver accepts on behalf of themselves/their employer sole responsibility to ensure that the load received is within the weight limit authorized by law and shall hold seller harmless against any and all claims with respect to same CURB DELIVERY ONLY. NOT RESPONSIBLE FOR ANY DAMAGE BEYOND CURB.

Received: _____
Weighmaster: Colleen LeSage

Cust: _____

P/D Status: Deliver

Customer Do Not Accept [3] Scale: 1



Plant: 32411

Berlin
368 New Brooklyn Road
Berlin, NJ 08009
856-809-0142

3/7/2017 10:41 In:
Customer: 8638404 THE AMBIENT GROUP LLC
Order: 950949 Camden, NJ. ABC Barrel Project
P.O.:

Tkt. No. 1006027221



Product 114203
Bank Run
S.O. Info: Camden, NJ.
Ship Ref: 327 N. Front St

	Pounds	Kilo
Gross	77,120	34,981
Tare	28,120 *	12,755
Net	49,000	22,226
	24.50 Ton	22.23

* Predetermined Tare

	UNIT	TOTALS
Material:		
Freight:		
Tax:		
Fee / Fuel:		
Other Chrg: No		

Today Tons:	245.39	Loads:
Tons To Date:	1,585.84	10
Today Tonnes	222.61	
Tonnes To Date:	1,438.65	

By acceptance of this ticket (with or without signature), driver accepts on behalf of themselves/their employer sole responsibility to ensure that the load received is within the weight limit authorized by law and shall hold seller harmless against any and all claims with respect to same CURB DELIVERY ONLY. NOT RESPONSIBLE FOR ANY DAMAGE BEYOND CURB.

Carrier: 8040648 GJ SCOTT LLC
Vehicle: GS16 GS16
License: AT639K
MaxGVW: 80,000

Received: _____
Weighmaster: Colleen LeSage

Cust: _____

P/D Status: Deliver

Customer Do Not Accept [2] Scale: 1



Plant: 32411

Berlin
368 New Brooklyn Road
Berlin, NJ 08009
856-809-0142

3/7/2017 10:48 In :
Customer: 8638404 THE AMBIENT GROUP LLC
Order : 950949 Camden, NJ. ABC Barrel Project
P.O. :

Tkt. No. 1006027222



Product 114203
Bank Run
S.O. Info: Camden, NJ.
Ship Ref: 327 N. Front St

	Pounds	Kilo
Gross	73,480	33,330
Tare	27,840 *	12,628
Net	45,640	20,702

22.82 Ton 20.70
* Predetermined Tare

UNIT	TOTALS
Material:	
Freight:	
Tax:	
Fee / Fuel:	
Other Chrg: No	

Today Tons:	268.21	Loads:
Tons To Date:	1,608.66	11
Today Tonnes	243.32	
Tonnes To Date:	1,459.35	

Carrier : 9249110 CLM CONTRACTING LLC
Vehicle: CLM6 CLM6
License: AT597T
MaxGVW: 80,000

By acceptance of this ticket (with or without signature), driver accepts on behalf of themselves/their employer sole responsibility to ensure that the load received is within the weight limit authorized by law and shall hold seller harmless against any and all claims with respect to same CURB DELIVERY ONLY. NOT RESPONSIBLE FOR ANY DAMAGE BEYOND CURB.

Received: _____
Weighmaster: Colleen LeSage

Cust: _____

P/D Status: Deliver

Customer Do Not Accept [2] Scale: 1



Plant: 32411

Berlin
368 New Brooklyn Road
Berlin, NJ 08009
856-809-0142

3/7/2017 10:50 In :
Customer: 8638404 THE AMBIENT GROUP LLC
Order : 950949 Camden, NJ. ABC Barrel Project
P.O. :

Tkt. No. 1006027223



Product 114203
Bank Run
S.O. Info: Camden, NJ.
Ship Ref: 327 N. Front St

	Pounds	Kilo
Gross	76,280	34,600
Tare	28,680 *	13,009
Net	47,600	21,591

23.80 Ton 21.59
* Predetermined Tare

UNIT	TOTALS
Material:	
Freight:	
Tax:	
Fee / Fuel:	
Other Chrg: No	

Today Tons:	292.01	Loads:
Tons To Date:	1,632.46	12
Today Tonnes	264.91	
Tonnes To Date:	1,480.94	

Carrier : 8040648 GJ SCOTT LLC
Vehicle: GS14 GS14
License: AS672T
MaxGVW: 80,000

By acceptance of this ticket (with or without signature), driver accepts on behalf of themselves/their employer sole responsibility to ensure that the load received is within the weight limit authorized by law and shall hold seller harmless against any and all claims with respect to same CURB DELIVERY ONLY. NOT RESPONSIBLE FOR ANY DAMAGE BEYOND CURB.

Received: _____
Weighmaster: Colleen LeSage

Cust: _____

P/D Status: Deliver

Customer Do Not Accept [2] Scale: 1



Plant: 32411

Berlin
368 New Brooklyn Road
Berlin, NJ 08009
856-809-0142

3/7/2017 11:56 In:
Customer: 8638404 THE AMBIENT GROUP LLC
Order : 950949 Camden, NJ. ABC Barrel Project
P.O. :

Tkt. No. 1006027227



Product 114203
Bank Run
S.O. Info: Camden, NJ.
Ship Ref: 327 N. Front St

	Pounds	Kilo
Gross	77,900	35,335
Tare	28,120 *	12,755
Net	49,780	22,580

24.89 Ton 22.58
* Predetermined Tare

	UNIT	TOTALS
Material:		
Freight:		
Tax:		
Fee / Fuel:		
Other Chrg: No		

Today Tons:	316.90	Loads:
Tons To Date:	1,657.35	13
Today Tonnes	287.49	
Tonnes To Date:	1,503.52	

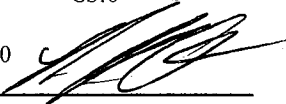
Carrier : 8040648 GJ SCOTT LLC
Vehicle: GS16 GS16
License: AT639K
MaxGVW: 80,000
Received: 
Weighmaster: Colleen LeSage

By acceptance of this ticket (with or without signature), driver accepts on behalf of themselves/their employer sole responsibility to ensure that the load received is within the weight limit authorized by law and shall hold seller harmless against any and all claims with respect to same CURB DELIVERY ONLY. NOT RESPONSIBLE FOR ANY DAMAGE BEYOND CURB.

Cust: _____

P/D Status: Deliver

Customer Do Not Accept [2] Scale: 1



Plant: 32411

Berlin
368 New Brooklyn Road
Berlin, NJ 08009
856-809-0142

3/7/2017 12:01 In:
Customer: 8638404 THE AMBIENT GROUP LLC
Order : 950949 Camden, NJ. ABC Barrel Project
P.O. :

Tkt. No. 1006027228



Product 114203
Bank Run
S.O. Info: Camden, NJ.
Ship Ref: 327 N. Front St

	Pounds	Kilo
Gross	74,160	33,638
Tare	25,460 *	11,548
Net	48,700	22,090

24.35 Ton 22.09
* Predetermined Tare

	UNIT	TOTALS
Material:		
Freight:		
Tax:		
Fee / Fuel:		
Other Chrg: No		

Today Tons:	341.25	Loads:
Tons To Date:	1,681.70	14
Today Tonnes	309.58	
Tonnes To Date:	1,525.61	

Carrier : 2347198 RAO CONTRACTING & MATE
Vehicle: RO223 Raio
License: AM608Y
MaxGVW: 80,000
Received: _____
Weighmaster: Colleen LeSage

By acceptance of this ticket (with or without signature), driver accepts on behalf of themselves/their employer sole responsibility to ensure that the load received is within the weight limit authorized by law and shall hold seller harmless against any and all claims with respect to same CURB DELIVERY ONLY. NOT RESPONSIBLE FOR ANY DAMAGE BEYOND CURB.

Cust: _____

P/D Status: Deliver

Customer Do Not Accept [2] Scale: 1



Plant: 32411

Berlin
368 New Brooklyn Road
Berlin, NJ 08009
856-809-0142

3/7/2017 12:07 In: 11:49:48
Customer: 8638404 THE AMBIENT GROUP LLC
Order: 950949 Camden, NJ. ABC Barrel Project
P.O.:

Tkt. No. 1006027229



Product 114203
Bank Run
S.O. Info: Camden, NJ.
Ship Ref: 327 N. Front St

	Pounds	Kilo
Gross	72,340	32,813
Tare	24,800	11,249
Net	47,540	21,564
	23.77 Ton	21.56

	UNIT	TOTALS
Material:		
Freight:		
Tax:		
Fee / Fuel:		
Other Chrg: No		

Today Tons:	365.02	Loads:
Tons To Date:	1,705.47	15
Today Tonnes	331.14	
Tonnes To Date:	1,547.18	

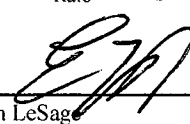
Carrier: 2347198 RAO CONTRACTING & MATE
Vehicle: RO213 Raio
License: AH445F
MaxGVW: 73,280
Received: 
Weighmaster: Colleen LeSage

By acceptance of this ticket (with or without signature), driver accepts on behalf of themselves/their employer sole responsibility to ensure that the load received is within the weight limit authorized by law and shall hold seller harmless against any and all claims with respect to same CURB DELIVERY ONLY. NOT RESPONSIBLE FOR ANY DAMAGE BEYOND CURB.

Cust: _____

P/D Status: Deliver

Customer Do Not Accept [2] Scale: 1



Plant: 32411

Berlin
368 New Brooklyn Road
Berlin, NJ 08009
856-809-0142

3/7/2017 12:09 In:
Customer: 8638404 THE AMBIENT GROUP LLC
Order: 950949 Camden, NJ. ABC Barrel Project
P.O.:

Tkt. No. 1006027230

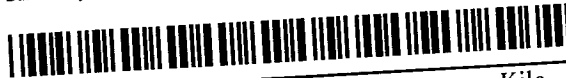

Product 114203
Bank Run
S.O. Info: Camden, NJ.
Ship Ref: 327 N. Front St

	Pounds	Kilo
Gross	78,340	35,534
Tare	28,680 *	13,009
Net	49,660	22,525
	24.83 Ton	22.53

	UNIT	TOTALS
Material:		
Freight:		
Tax:		
Fee / Fuel:		
Other Chrg: No		

Today Tons:	389.85	Loads:
Tons To Date:	1,730.30	16
Today Tonnes	353.67	
Tonnes To Date:	1,569.70	

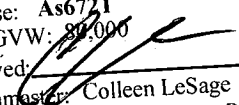
Carrier: 8040648 GJ SCOTT LLC
Vehicle: GS14 GS14
License: As672T
MaxGVW: 80,000
Received: 
Weighmaster: Colleen LeSage

By acceptance of this ticket (with or without signature), driver accepts on behalf of themselves/their employer sole responsibility to ensure that the load received is within the weight limit authorized by law and shall hold seller harmless against any and all claims with respect to same CURB DELIVERY ONLY. NOT RESPONSIBLE FOR ANY DAMAGE BEYOND CURB.

Cust: _____

P/D Status: Deliver

Customer Do Not Accept [3] Scale: 1



Plant: 32411

Berlin
368 New Brooklyn Road
Berlin, NJ 08009
856-809-0142, -

3/7/2017 12:12 In:
Customer: 8638404 THE AMBIENT GROUP LLC
Order: 950949 Camden, NJ. ABC Barrel Project
P.O.:

Tkt. No. 1006027231

Product 114203
Bank Run
S.O. Info: Camden, NJ.
Ship Ref: 327 N. Front St



	Pounds	Kilo
Gross	77,520	35,162
Tare	27,840 *	12,628
Net	49,680	22,534

24.84 Ton 22.53
* Predetermined Tare

UNIT	TOTALS
Material:	
Freight:	
Tax:	
Fee / Fuel:	
Other Chrg: No	

Today Tons:	414.69	Loads:	
Tons To Date:	1,755.14		17
Today Tonnes	376.20		
Tonnes To Date:	1,592.24		

Carrier: 9249110 CLM CONTRACTING LLC
Vehicle: CLM6 CLM6
License: AT597T
MaxGVW: 80,000

By acceptance of this ticket (with or without signature), driver accepts on behalf of themselves/their employer sole responsibility to ensure that the load received is within the weight limit authorized by law and shall hold seller harmless against any and all claims with respect to same CURB DELIVERY ONLY. NOT RESPONSIBLE FOR ANY DAMAGE BEYOND CURB.

Received: _____
Weighmaster: Colleen LeSage

Cust: _____

P/D Status: Deliver

Customer Do Not Accept [2] Scale: 1



Plant: 32411

Berlin
368 New Brooklyn Road
Berlin, NJ 08009
856-809-0142,

3/7/2017 13:48 In:
Customer: 8638404 THE AMBIENT GROUP LLC
Order: 950949 Camden, NJ. ABC Barrel Project
P.O.:

Tkt. No. 1006027238

Product 114203
Bank Run
S.O. Info: Camden, NJ.
Ship Ref: 327 N. Front St



	Pounds	Kilo
Gross	77,280	35,054
Tare	27,840 *	12,628
Net	49,440	22,426

24.72 Ton 22.43
* Predetermined Tare

UNIT	TOTALS
Material:	
Freight:	
Tax:	
Fee / Fuel:	
Other Chrg: No	

Today Tons:	489.65	Loads:	
Tons To Date:	1,830.10		20
Today Tonnes	444.20		
Tonnes To Date:	1,660.24		

Carrier: 9249110 CLM CONTRACTING LLC
Vehicle: CLM6 CLM6
License: AT597T
MaxGVW: 80,000

By acceptance of this ticket (with or without signature), driver accepts on behalf of themselves/their employer sole responsibility to ensure that the load received is within the weight limit authorized by law and shall hold seller harmless against any and all claims with respect to same CURB DELIVERY ONLY. NOT RESPONSIBLE FOR ANY DAMAGE BEYOND CURB.

Received: _____
Weighmaster: Colleen LeSage

Cust: _____

P/D Status: Deliver

Customer Do Not Accept [2] Scale: 1



Plant: 32411

Berlin
368 New Brooklyn Road
Berlin, NJ 08009
856-809-0142

3/7/2017 13:42 In:
Customer: 8638404 THE AMBIENT GROUP LLC
Order : 950949 Camden, NJ. ABC Barrel Project
P.O. :

Tkt. No. 1006027236



Product 114203
Bank Run
S.O. Info: Camden, NJ.
Ship Ref: 327 N. Front St

	Pounds	Kilo
Gross	78,320	35,525
Tare	28,120 *	12,755
Net	50,200	22,770

25.10 Ton 22.77
* Predetermined Tare

	UNIT	TOTALS
Material:		
Freight:		
Tax:		
Fee / Fuel:		
Other Chrg: No		

Today Tons:	439.79	Loads:
Tons To Date:	1,780.24	18
Today Tonnes	398.97	
Tonnes To Date:	1,615.01	

Carrier : 8040648 GJ SCOTT LLC
Vehicle: GS16 GS16
License: AT639K
MaxGVW: 80,000

By acceptance of this ticket (with or without signature), driver accepts on behalf of themselves/their employer sole responsibility to ensure that the load received is within the weight limit authorized by law and shall hold seller harmless against any and all claims with respect to same CURB DELIVERY ONLY. NOT RESPONSIBLE FOR ANY DAMAGE BEYOND CURB.

Received:  Cust: _____

Weighmaster: Colleen LeSage

P/D Status: Deliver

Customer Do Not Accept [2] Scale: 1



Plant: 32411

Berlin
368 New Brooklyn Road
Berlin, NJ 08009
856-809-0142

3/7/2017 13:47 In:
Customer: 8638404 THE AMBIENT GROUP LLC
Order : 950949 Camden, NJ. ABC Barrel Project
P.O. :

Tkt. No. 1006027237



Product 114203
Bank Run
S.O. Info: Camden, NJ.
Ship Ref: 327 N. Front St

	Pounds	Kilo
Gross	78,960	35,816
Tare	28,680 *	13,009
Net	50,280	22,807

25.14 Ton 22.81
* Predetermined Tare

	UNIT	TOTALS
Material:		
Freight:		
Tax:		
Fee / Fuel:		
Other Chrg: No		

Today Tons:	464.93	Loads:
Tons To Date:	1,805.38	19
Today Tonnes	421.78	
Tonnes To Date:	1,637.81	

Carrier : 8040648 GJ SCOTT LLC
Vehicle: GS14 GS14
License: As672
MaxGVW: 80,000

By acceptance of this ticket (with or without signature), driver accepts on behalf of themselves/their employer sole responsibility to ensure that the load received is within the weight limit authorized by law and shall hold seller harmless against any and all claims with respect to same CURB DELIVERY ONLY. NOT RESPONSIBLE FOR ANY DAMAGE BEYOND CURB.

Received:  Cust: _____

Weighmaster: Colleen LeSage

P/D Status: Deliver

Customer Copy Scale: 1



Plant: 32411

Berlin
368 New Brooklyn Road
Berlin, NJ 08009
856-809-0142

3/8/2017 07:22 In: 6:21:27
Customer: 8638404 THE AMBIENT GROUP LLC
Order : 950949 Camden, NJ. ABC Barrel Project
P.O. :

Tkt. No. 1006027241



Product 114203
Bank Run
S.O. Info: Camden, NJ.
Ship Ref: 327 N. Front St

	Pounds	Kilo
Gross	77,420	35,117
Tare	26,500	12,020
Net	50,920	23,097

25.46 Ton 23.10

UNIT	TOTALS
Material:	
Freight:	
Tax:	
Fee / Fuel:	
Other Chrg: No	

Today Tons:	25.46	Loads:
Tons To Date:	1,855.56	1
Today Tonnes	23.10	
Tonnes To Date:	1,683.34	

Carrier : 2347243 A P SIMIONE
Vehicle: SA194 Simione
License: AB423G
MaxGVW: 80,000

By acceptance of this ticket (with or without signature), driver accepts on behalf of themselves/their employer sole responsibility to ensure that the load received is within the weight limit authorized by law and shall hold seller harmless against any and all claims with respect to same CURB DELIVERY ONLY. NOT RESPONSIBLE FOR ANY DAMAGE BEYOND CURB.

Received: _____ Cust: _____

Weighmaster: Colleen LeSage

P/D Status: Deliver

Customer Do Not Accept [2] Scale: 1



Plant: 32411

Berlin
368 New Brooklyn Road
Berlin, NJ 08009
856-809-0142

3/8/2017 07:24 In: 6:48:55
Customer: 8638404 THE AMBIENT GROUP LLC
Order : 950949 Camden, NJ. ABC Barrel Project
P.O. :

Tkt. No. 1006027242



Product 114203
Bank Run
S.O. Info: Camden, NJ.
Ship Ref: 327 N. Front St

	Pounds	Kilo
Gross	77,200	35,017
Tare	24,640	11,177
Net	52,560	23,841

26.28 Ton 23.84

UNIT	TOTALS
Material:	
Freight:	
Tax:	
Fee / Fuel:	
Other Chrg: No	

Today Tons:	51.74	Loads:
Tons To Date:	1,881.84	2
Today Tonnes	46.94	
Tonnes To Date:	1,707.18	

Carrier : 2346970 GEORGE LAZOS TRUCKING
Vehicle: LG004 AP213T
License: LG004
MaxGVW: 80,000

By acceptance of this ticket (with or without signature), driver accepts on behalf of themselves/their employer sole responsibility to ensure that the load received is within the weight limit authorized by law and shall hold seller harmless against any and all claims with respect to same CURB DELIVERY ONLY. NOT RESPONSIBLE FOR ANY DAMAGE BEYOND CURB.

Received: _____ Cust: _____

Weighmaster: Colleen LeSage

P/D Status: Deliver

Customer Copy Scale: 1



Plant: 32411

Berlin

368 New Brooklyn Road
Berlin, NJ 08009
856-809-0142

3/8/2017 07:29

In :

Customer: 8638404 THE AMBIENT GROUP LLC

Order : 950949 Camden, NJ. ABC Barrel Project

P.O. :

Tkt. No. 1006027243

Product 114203

Bank Run

S.O. Info: Camden, NJ.

Ship Ref: 327 N. Front St



	Pounds	Kilo
Gross	75,280	34,146
Tare	24,740 *	11,222
Net	50,540	22,925

25.27 Ton 22.92

* Predetermined Tare

Today Tons:	77.01	Loads:
Tons To Date:	1,907.11	3
Today Tonnes	69.86	
Tonnes To Date:	1,730.10	

	UNIT	TOTALS
Material:		
Freight:		
Tax:		
Fee / Fuel:		
Other Chrg: No		

Carrier : 2347198 RAIO CONTRACTING & MATE

Vehicle: RO227 Raio

License: AR332D

MaxGVW: 80,000

Received:

Weighmaster: Colleen LeSage

P/D Status: Deliver

Cust: _____

By acceptance of this ticket (with or without signature), driver accepts on behalf of themselves/their employer sole responsibility to ensure that the load received is within the weight limit authorized by law and shall holdseller harmless against any and all claims with respect to same CURB DELIVERY ONLY. NOT RESPONSIBLE FOR ANY DAMAGE BEYOND CURB.

Customer Copy

Scale: 1



Plant: 32411

Berlin

368 New Brooklyn Road
Berlin, NJ 08009
856-809-0142

3/8/2017 07:31

In : 7:01:39

Customer: 8638404 THE AMBIENT GROUP LLC

Order : 950949 Camden, NJ. ABC Barrel Project

P.O. :

Tkt. No. 1006027244

Product 114203

Bank Run

S.O. Info: Camden, NJ.

Ship Ref: 327 N. Front St



	Pounds	Kilo
Gross	75,360	34,183
Tare	24,820	11,258
Net	50,540	22,925

25.27 Ton 22.92

Today Tons:	102.28	Loads:
Tons To Date:	1,932.38	4
Today Tonnes	92.79	
Tonnes To Date:	1,753.03	

	UNIT	TOTALS
Material:		
Freight:		
Tax:		
Fee / Fuel:		
Other Chrg: No		

Carrier : 2347198 RAIO CONTRACTING & MATE

Vehicle: RO228 Raio

License: AR331D

MaxGVW: 80,000

Received:

Weighmaster: Colleen LeSage

P/D Status: Deliver

Cust: _____

By acceptance of this ticket (with or without signature), driver accepts on behalf of themselves/their employer sole responsibility to ensure that the load received is within the weight limit authorized by law and shall holdseller harmless against any and all claims with respect to same CURB DELIVERY ONLY. NOT RESPONSIBLE FOR ANY DAMAGE BEYOND CURB.

Customer Copy

Scale: 1



Plant: 32411

Berlin

368 New Brooklyn Road
Berlin, NJ 08009
856-809-0142

3/8/2017 07:41 In: 7:17:47
Customer: 8638404 THE AMBIENT GROUP LLC
Order: 950949 Camden, NJ. ABC Barrel Project
P.O.:

Tkt. No. 1006027245

Product 114203
Bank Run
S.O. Info: Camden, NJ.
Ship Ref: 327 N. Front St



	Pounds	Kilo
Gross	74,280	33,693
Tare	24,760	11,231
Net	49,520	22,462

24.76 Ton 22.46

	UNIT	TOTALS
Material:		
Freight:		
Tax:		
Fee / Fuel:		
Other Chrg: No		

Today Tons:	127.04	Loads:
Tons To Date:	1,957.14	5
Today Tonnes	115.25	
Tonnes To Date:	1,775.49	

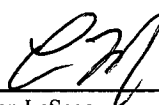
Carrier: 2347198 RAIO CONTRACTING & MATE
Vehicle: RO213 Raio
License: AH445F
MaxGVW: 80,000
Received: 

By acceptance of this ticket (with or without signature), driver accepts on behalf of themselves/their employer sole responsibility to ensure that the load received is within the weight limit authorized by law and shall hold seller harmless against any and all claims with respect to same CURB DELIVERY ONLY. NOT RESPONSIBLE FOR ANY DAMAGE BEYOND CURB.

Cust: _____

Weighmaster: Colleen LeSage

P/D Status: Deliver

Customer Do Not Accept [1] Scale: 1



Plant: 32411

Berlin

368 New Brooklyn Road
Berlin, NJ 08009
856-809-0142

3/8/2017 07:44 In: 7:19:09
Customer: 8638404 THE AMBIENT GROUP LLC
Order: 950949 Camden, NJ. ABC Barrel Project
P.O.:

Tkt. No. 1006027246

Product 114203
Bank Run
S.O. Info: Camden, NJ.
Ship Ref: 327 N. Front St



	Pounds	Kilo
Gross	75,460	34,228
Tare	25,080	11,376
Net	50,380	22,852

25.19 Ton 22.85

	UNIT	TOTALS
Material:		
Freight:		
Tax:		
Fee / Fuel:		
Other Chrg: No		

Today Tons:	152.23	Loads:
Tons To Date:	1,982.33	6
Today Tonnes	138.10	
Tonnes To Date:	1,798.34	

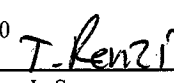
Carrier: 2347198 RAIO CONTRACTING & MATE
Vehicle: RO222 AK269E
License: AK269e
MaxGVW: 80,000
Received: 

By acceptance of this ticket (with or without signature), driver accepts on behalf of themselves/their employer sole responsibility to ensure that the load received is within the weight limit authorized by law and shall hold seller harmless against any and all claims with respect to same CURB DELIVERY ONLY. NOT RESPONSIBLE FOR ANY DAMAGE BEYOND CURB.

Cust: _____

Weighmaster: Colleen LeSage

P/D Status: Deliver

Customer Do Not Accept [2] Scale: 1



Plant: 32411

Berlin

368 New Brooklyn Road

Berlin, NJ 08009

856-809-0142

3/8/2017 08:04 In: 7:37:44
Customer: 8638404 THE AMBIENT GROUP LLC
Order: 950949 Camden, NJ. ABC Barrel Project
P.O.:

Tkt. No. 1006027250

Product 114203
Bank Run
S.O. Info: Camden, NJ.
Ship Ref: 327 N. Front St



	Pounds	Kilo
Gross	77,800	35,289
Tare	28,080	12,737
Net	49,720	22,553

24.86 Ton 22.55

	UNIT	TOTALS
Material:		
Freight:		
Tax:		
Fee / Fuel:		
Other Chrg: No		

Today Tons:	177.09	Loads:
Tons To Date:	2,007.19	7
Today Tonnes	160.65	
Tonnes To Date:	1,820.89	

Carrier: 8040648 GJ SCOTT LLC
Vehicle: GS16 GS16
License: AT639K
MaxGVW: 80,000

By acceptance of this ticket (with or without signature), driver accepts on behalf of themselves/their employer sole responsibility to ensure that the load received is within the weight limit authorized by law and shall hold seller harmless against any and all claims with respect to same CURB DELIVERY ONLY. NOT RESPONSIBLE FOR ANY DAMAGE BEYOND CURB.

Received:

Cust: _____

Weighmaster: Colleen LeSage

P/D Status: Deliver

Customer Do Not Accept [2] Scale: 1



Plant: 32411

Berlin

368 New Brooklyn Road

Berlin, NJ 08009

856-809-0142

3/8/2017 08:07 In: 7:38:06
Customer: 8638404 THE AMBIENT GROUP LLC
Order: 950949 Camden, NJ. ABC Barrel Project
P.O.:

Tkt. No. 1006027251

Product 114203
Bank Run
S.O. Info: Camden, NJ.
Ship Ref: 327 N. Front St



	Pounds	Kilo
Gross	77,440	35,126
Tare	28,700	13,018
Net	48,740	22,108

24.37 Ton 22.11

	UNIT	TOTALS
Material:		
Freight:		
Tax:		
Fee / Fuel:		
Other Chrg: No		

Today Tons:	201.46	Loads:
Tons To Date:	2,031.56	8
Today Tonnes	182.76	
Tonnes To Date:	1,843.00	

Carrier: 8040648 GJ SCOTT LLC
Vehicle: GS14 GS14
License: As672T
MaxGVW: 80,000

By acceptance of this ticket (with or without signature), driver accepts on behalf of themselves/their employer sole responsibility to ensure that the load received is within the weight limit authorized by law and shall hold seller harmless against any and all claims with respect to same CURB DELIVERY ONLY. NOT RESPONSIBLE FOR ANY DAMAGE BEYOND CURB.

Received: _____

Cust: _____

Weighmaster: Colleen LeSage

P/D Status: Deliver

Customer Do Not Accept [2] Scale: 1



Plant: 32411

Berlin

368 New Brooklyn Road
Berlin, NJ 08009
856-809-0142

3/8/2017 08:10 In: 7:55:00
Customer: 8638404 THE AMBIENT GROUP LLC
Order: 950949 Camden, NJ. ABC Barrel Project
P.O.:

Tkt. No. 1006027252



Product 114203
Bank Run
S.O. Info: Camden, NJ
Ship Ref: 327 N. Front St

	Pounds	Kilo
Gross	75,720	34,346
Tare	25,400	11,521
Net	50,320	22,825
	25.16 Ton	22.82

	UNIT	TOTALS
Material:		
Freight:		
Tax:		
Fee / Fuel:		
Other Chrg: No		

Today Tons:	226.62	Loads:
Tons To Date:	2,056.72	9
Today Tonnes	205.59	
Tonnes To Date:	1,865.82	

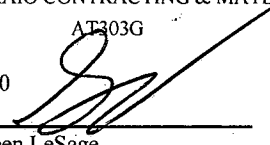
Carrier: 2347198 RAIO CONTRACTING & MATE
Vehicle: RO207 AT303G
License: AT303G
MaxGVW: 80,000
Received: 
Weighmaster: Colleen LeSage

By acceptance of this ticket (with or without signature), driver accepts on behalf of themselves/their employer sole responsibility to ensure that the load received is within the weight limit authorized by law and shall hold seller harmless against any and all claims with respect to same CURB DELIVERY ONLY. NOT RESPONSIBLE FOR ANY DAMAGE BEYOND CURB.

Cust: _____

P/D Status: Deliver

Customer Copy

Scale: 1



Plant: 32411

Berlin

368 New Brooklyn Road
Berlin, NJ 08009
856-809-0142

3/8/2017 09:14 In:
Customer: 8638404 THE AMBIENT GROUP LLC
Order: 950949 Camden, NJ. ABC Barrel Project
P.O.:

Tkt. No. 1006027264



Product 114203
Bank Run
S.O. Info: Camden, NJ
Ship Ref: 327 N. Front St

	Pounds	Kilo
Gross	78,740	35,716
Tare	26,500 *	12,020
Net	52,240	23,696
	26.12 Ton	23.70

* Predetermined Tare

	UNIT	TOTALS
Material:		
Freight:		
Tax:		
Fee / Fuel:		
Other Chrg: No		

Today Tons:	252.74	Loads:
Tons To Date:	2,082.84	10
Today Tonnes	229.28	
Tonnes To Date:	1,889.52	

Carrier: 2347243 A P SIMIONE
Vehicle: SA194 Simione
License: AB423G
MaxGVW: 80,000
Received: _____
Weighmaster: Colleen LeSage

By acceptance of this ticket (with or without signature), driver accepts on behalf of themselves/their employer sole responsibility to ensure that the load received is within the weight limit authorized by law and shall hold seller harmless against any and all claims with respect to same CURB DELIVERY ONLY. NOT RESPONSIBLE FOR ANY DAMAGE BEYOND CURB.

Cust: _____

P/D Status: Deliver

Customer Copy

Scale: 1



Plant: 32411

Berlin

368 New Brooklyn Road
Berlin, NJ 08009
856-809-0142

3/8/2017 09:21 In :
Customer: 8638404 THE AMBIENT GROUP LLC
Order : 950949 Camden, NJ. ABC Barrel Project
P.O. :

Tkt. No. 1006027265

Product 114203
Bank Run
S.O. Info: Camden, NJ.
Ship Ref: 327 N. Front St



	Pounds	Kilo
Gross	76,540	34,718
Tare	24,640 *	11,177
Net	51,900	23,541

25.95 Ton 23.54

* Predetermined Tare

	UNIT	TOTALS
Material:		
Freight:		
Tax:		
Fee / Fuel:		
Other Chrg: No		

Today Tons:	278.69	Loads:
Tons To Date:	2,108.79	11
Today Tonnes	252.82	
Tonnes To Date:	1,913.06	

Carrier : 2346970 GEORGE LAZOS TRUCKING
Vehicle: LG004 AP213T
License: LG004
MaxGVW: 80,000
Received: _____
Weighmaster: Colleen LeSage

By acceptance of this ticket (with or without signature), driver accepts on behalf of themselves/their employer sole responsibility to ensure that the load received is within the weight limit authorized by law and shall hold seller harmless against any and all claims with respect to same CURB DELIVERY ONLY. NOT RESPONSIBLE FOR ANY DAMAGE BEYOND CURB.

Cust: _____

P/D Status: Deliver

Customer Copy

Scale: 1



Plant: 32411

Berlin

368 New Brooklyn Road
Berlin, NJ 08009
856-809-0142

3/8/2017 09:50 In :
Customer: 8638404 THE AMBIENT GROUP LLC
Order : 950949 Camden, NJ. ABC Barrel Project
P.O. :

Tkt. No. 1006027267

Product 114203
Bank Run
S.O. Info: Camden, NJ.
Ship Ref: 327 N. Front St



	Pounds	Kilo
Gross	78,420	35,571
Tare	28,080 *	12,737
Net	50,340	22,834

25.17 Ton 22.83

* Predetermined Tare

	UNIT	TOTALS
Material:		
Freight:		
Tax:		
Fee / Fuel:		
Other Chrg: No		

Today Tons:	303.86	Loads:
Tons To Date:	2,133.96	12
Today Tonnes	275.66	
Tonnes To Date:	1,935.90	

Carrier : 8040648 GJ SCOTT LLC
Vehicle: GS16 GS16
License: AT639K
MaxGVW: 80,000
Received: _____
Weighmaster: Colleen LeSage

By acceptance of this ticket (with or without signature), driver accepts on behalf of themselves/their employer sole responsibility to ensure that the load received is within the weight limit authorized by law and shall hold seller harmless against any and all claims with respect to same CURB DELIVERY ONLY. NOT RESPONSIBLE FOR ANY DAMAGE BEYOND CURB.

Cust: _____

P/D Status: Deliver

Customer Do Not Accept [3]

Scale: 1



Plant: 32411

Berlin

368 New Brooklyn Road
Berlin, NJ 08009
856-809-0142

3/8/2017 09:54

In :

Customer: 8638404 THE AMBIENT GROUP LLC

Order : 950949 Camden, NJ. ABC Barrel Project

P.O. :

Tkt. No. 1006027268

Product 114203

Bank Run

S.O. Info: Camden, NJ.

Ship Ref: 327 N. Front St



	Pounds	Kilo
Gross	78,720	35,707
Tare	28,700 *	13,018
Net	50,020	22,689

25.01 Ton 22.69

* Predetermined Tare

	UNIT	TOTALS
Material:		
Freight:		
Tax:		
Fee / Fuel:		
Other Chrg: No		

Today Tons:	328.87	Loads:
Tons To Date:	2,158.97	13
Today Tonnes	298.35	
Tonnes To Date:	1,958.58	

Carrier : 8040648 GJ SCOTT LLC

Vehicle: GS14 GS14

License: As672T

MaxGVW: 80,000

Received: _____

Weighmaster: Colleen LeSage

Cust: _____

By acceptance of this ticket (with or without signature), driver accepts on behalf of themselves/their employer sole responsibility to ensure that the load received is within the weight limit authorized by law and shall holdseller harmless against any and all claims with respect to same CURB DELIVERY ONLY. NOT RESPONSIBLE FOR ANY DAMAGE BEYOND CURB.

P/D Status: Deliver

Customer Copy

Scale: 1



Plant: 32411

Berlin

368 New Brooklyn Road
Berlin, NJ 08009
856-809-0142

3/8/2017 10:10

In :

Customer: 8638404 THE AMBIENT GROUP LLC

Order : 950949 Camden, NJ. ABC Barrel Project

P.O. :

Tkt. No. 1006027269

Product 114203

Bank Run

S.O. Info: Camden, NJ.

Ship Ref: 327 N. Front St



	Pounds	Kilo
Gross	74,380	33,738
Tare	24,740 *	11,222
Net	49,640	22,516

24.82 Ton 22.52

* Predetermined Tare

	UNIT	TOTALS
Material:		
Freight:		
Tax:		
Fee / Fuel:		
Other Chrg: No		

Today Tons:	353.69	Loads:
Tons To Date:	2,183.79	14
Today Tonnes	320.86	
Tonnes To Date:	1,981.10	

Carrier : 2347198 RAO CONTRACTING & MATE

Vehicle: RO227 Raio

License: AR332D

MaxGVW: 80,000

Received: _____

Weighmaster: Colleen LeSage

Cust: _____

By acceptance of this ticket (with or without signature), driver accepts on behalf of themselves/their employer sole responsibility to ensure that the load received is within the weight limit authorized by law and shall holdseller harmless against any and all claims with respect to same CURB DELIVERY ONLY. NOT RESPONSIBLE FOR ANY DAMAGE BEYOND CURB.

P/D Status: Deliver

Customer Copy

Scale: 1



Plant: 32411

Berlin

368 New Brooklyn Road
Berlin, NJ 08009
856-809-0142

3/8/2017 10:46 In :
Customer: 8638404 THE AMBIENT GROUP LLC
Order : 950949 Camden, NJ. ABC Barrel Project
P.O. :

Tkt. No. 1006027272



Product 114203
Bank Run
S.O. Info: Camden, NJ.
Ship Ref: 327 N. Front St

	Pounds	Kilo
Gross	79,260	35,952
Tare	26,500 *	12,020
Net	52,760	23,932

26.38 Ton 23.93

* Predetermined Tare

	UNIT	TOTALS
Material:		
Freight:		
Tax:		
Fee / Fuel:		
Other Chrg: No		

Today Tons:	380.07	Loads:
Tons To Date:	2,210.17	15
Today Tonnes	344.79	
Tonnes To Date:	2,005.03	

By acceptance of this ticket (with or without signature), driver accepts on behalf of themselves/their employer sole responsibility to ensure that the load received is within the weight limit authorized by law and shall hold seller harmless against any and all claims with respect to same CURB DELIVERY ONLY. NOT RESPONSIBLE FOR ANY DAMAGE BEYOND CURB.

Carrier : 2347243 A P SIMIONE
Vehicle: SA194 Simione
License: AB423G
MaxGVW: 80,000

Received: _____ Cust: _____

Weighmaster: Colleen LeSage

P/D Status: Deliver

Customer Copy

Scale: 1



Plant: 32411

Berlin

368 New Brooklyn Road
Berlin, NJ 08009
856-809-0142

3/8/2017 10:54 In :
Customer: 8638404 THE AMBIENT GROUP LLC
Order : 950949 Camden, NJ. ABC Barrel Project
P.O. :

Tkt. No. 1006027273



Product 114203
Bank Run
S.O. Info: Camden, NJ.
Ship Ref: 327 N. Front St

	Pounds	Kilo
Gross	77,560	35,181
Tare	24,640 *	11,177
Net	52,920	24,004

26.46 Ton 24.00

* Predetermined Tare

	UNIT	TOTALS
Material:		
Freight:		
Tax:		
Fee / Fuel:		
Other Chrg: No		

Today Tons:	406.53	Loads:
Tons To Date:	2,236.63	16
Today Tonnes	368.80	
Tonnes To Date:	2,029.04	

By acceptance of this ticket (with or without signature), driver accepts on behalf of themselves/their employer sole responsibility to ensure that the load received is within the weight limit authorized by law and shall hold seller harmless against any and all claims with respect to same CURB DELIVERY ONLY. NOT RESPONSIBLE FOR ANY DAMAGE BEYOND CURB.

Carrier : 2346970 GEORGE LAZOS TRUCKING
Vehicle: LG004 AP213T
License: LG004
MaxGVW: 80,000

Received: _____ Cust: _____

Weighmaster: Colleen LeSage

P/D Status: Deliver

Customer Copy

Scale: 1



Plant: 32411

Berlin

368 New Brooklyn Road
Berlin, NJ 08009
856-809-0142

3/8/2017 11:19 In: 10:54:15
Customer: 8638404 THE AMBIENT GROUP LLC
Order: 950949 Camden, NJ. ABC Barrel Project
P.O.:

Tkt. No. 1006027275



Product 114203
Bank Run
S.O. Info: Camden, NJ.
Ship Ref: 327 N. Front St

	Pounds	Kilo
Gross	76,620	34,754
Tare	27,340	12,401
Net	49,280	22,353
	24.64 Ton	22.35

UNIT	TOTALS
Material:	
Freight:	
Tax:	
Fee / Fuel:	
Other Chrg: No	

Today Tons:	431.17	Loads:
Tons To Date:	2,261.27	17
Today Tonnes	391.15	
Tonnes To Date:	2,051.39	

Carrier: 9249110 CLM CONTRACTING LLC
Vehicle: CLM6 CLM6
License: AT597T
MaxGVW: 80,000
Received:
Weighmaster: Colleen LeSage

By acceptance of this ticket (with or without signature), driver accepts on behalf of themselves/their employer sole responsibility to ensure that the load received is within the weight limit authorized by law and shall hold seller harmless against any and all claims with respect to same CURB DELIVERY ONLY. NOT RESPONSIBLE FOR ANY DAMAGE BEYOND CURB.

Cust: _____

P/D Status: Deliver

Customer Copy Scale: 1



Plant: 32411

Berlin

368 New Brooklyn Road
Berlin, NJ 08009
856-809-0142

3/8/2017 12:21 In:
Customer: 8638404 THE AMBIENT GROUP LLC
Order: 950949 Camden, NJ. ABC Barrel Project
P.O.:

Tkt. No. 1006027278



Product 114203
Bank Run
S.O. Info: Camden, NJ.
Ship Ref: 327 N. Front St

	Pounds	Kilo
Gross	78,240	35,489
Tare	26,500 *	12,020
Net	51,740	23,469
	25.87 Ton	23.47

UNIT	TOTALS
Material:	
Freight:	
Tax:	
Fee / Fuel:	
Other Chrg: No	

* Predetermined Tare

Today Tons:	457.04	Loads:
Tons To Date:	2,287.14	18
Today Tonnes	414.62	
Tonnes To Date:	2,074.86	

Carrier: 2347243 A P SIMIONE
Vehicle: SA194 Simione
License: AB423G
MaxGVW: 80,000
Received: _____
Weighmaster: Colleen LeSage

By acceptance of this ticket (with or without signature), driver accepts on behalf of themselves/their employer sole responsibility to ensure that the load received is within the weight limit authorized by law and shall hold seller harmless against any and all claims with respect to same CURB DELIVERY ONLY. NOT RESPONSIBLE FOR ANY DAMAGE BEYOND CURB.

Cust: _____

P/D Status: Deliver

Customer Copy Scale: 1



Plant: 32411

Berlin

368 New Brooklyn Road
Berlin, NJ 08009
856-809-0142

3/8/2017 12:24 In:
Customer: 8638404 THE AMBIENT GROUP LLC
Order : 950949 Camden, NJ. ABC Barrel Project
P.O. :

Tkt. No. 1006027279



Product 114203
Bank Run
S.O. Info: Camden, NJ.
Ship Ref: 327 N. Front St

	Pounds	Kilo
Gross	77,400	35,108
Tare	24,640 *	11,177
Net	52,760	23,932

26.38 Ton 23.93

* Predetermined Tare

	UNIT	TOTALS
Material:		
Freight:		
Tax:		
Fee / Fuel:		
Other Chrg:	No	

Today Tons:	483.42	Loads:
Tons To Date:	2,313.52	19
Today Tonnes	438.55	
Tonnes To Date:	2,098.79	

By acceptance of this ticket (with or without signature), driver accepts on behalf of themselves/their employer sole responsibility to ensure that the load received is within the weight limit authorized by law and shall hold seller harmless against any and all claims with respect to same CURB DELIVERY ONLY. NOT RESPONSIBLE FOR ANY DAMAGE BEYOND CURB.

Carrier : 2346970 GEORGE LAZOS TRUCKING
Vehicle: LG004 AP213T
License: LG004
MaxGVW: 80,000
Received: _____
Weighmaster: Colleen LeSage

Cust: _____

P/D Status: Deliver

Customer Copy

Scale: 1



Plant: 32411

Berlin

368 New Brooklyn Road
Berlin, NJ 08009
856-809-0142

3/8/2017 13:06 In:
Customer: 8638404 THE AMBIENT GROUP LLC
Order : 950949 Camden, NJ. ABC Barrel Project
P.O. :

Tkt. No. 1006027282



Product 114203
Bank Run
S.O. Info: Camden, NJ.
Ship Ref: 327 N. Front St

	Pounds	Kilo
Gross	78,300	35,516
Tare	27,340 *	12,401
Net	50,960	23,115

25.48 Ton 23.12

* Predetermined Tare

	UNIT	TOTALS
Material:		
Freight:		
Tax:		
Fee / Fuel:		
Other Chrg:	No	

Today Tons:	508.90	Loads:
Tons To Date:	2,339.00	20
Today Tonnes	461.67	
Tonnes To Date:	2,121.91	

By acceptance of this ticket (with or without signature), driver accepts on behalf of themselves/their employer sole responsibility to ensure that the load received is within the weight limit authorized by law and shall hold seller harmless against any and all claims with respect to same CURB DELIVERY ONLY. NOT RESPONSIBLE FOR ANY DAMAGE BEYOND CURB.

Carrier : 9249110 CLM CONTRACTING LLC
Vehicle: CLM6 CLM6
License: AT597T
MaxGVW: 80,000
Received: _____
Weighmaster: Colleen LeSage

Cust: _____

P/D Status: Deliver

Customer Do Not Accept [2]

Scale: 1



Plant: 32411

Berlin
368 New Brooklyn Road
Berlin, NJ 08009
856-809-0142

3/8/2017 13:49 In:
Customer: 8638404 THE AMBIENT GROUP LLC
Order : 950949 Camden, NJ. ABC Barrel Project
P.O. :

Tkt. No. 1006027285

Product 114203
Bank Run
S.O. Info: Camden, NJ.
Ship Ref: 327 N. Front St



	Pounds	Kilo
Gross	78,620	35,661
Tare	26,500 *	12,020
Net	52,120	23,641

26.06 Ton 23.64

* Predetermined Tare

	UNIT	TOTALS
Material:		
Freight:		
Tax:		
Fee / Fuel:		
Other Chrg: No		

Today Tons:	534.96	Loads:
Tons To Date:	2,365.06	21
Today Tonnes	485.31	
Tonnes To Date:	2,145.55	

Carrier : 2347243 A P SIMIONE
Vehicle: SA194 Simione
License: AB423G
MaxGVW: 80,000

By acceptance of this ticket (with or without signature), driver accepts on behalf of themselves/their employer sole responsibility to ensure that the load received is within the weight limit authorized by law and shall hold seller harmless against any and all claims with respect to same CURB DELIVERY ONLY. NOT RESPONSIBLE FOR ANY DAMAGE BEYOND CURB.

Received: _____
Weighmaster: Colleen LeSage

Cust: _____

P/D Status: Deliver

Customer Do Not Accept [2] Scale: 1



Plant: 32411

Berlin
368 New Brooklyn Road
Berlin, NJ 08009
856-809-0142

3/8/2017 14:05 In:
Customer: 8638404 THE AMBIENT GROUP LLC
Order : 950949 Camden, NJ. ABC Barrel Project
P.O. :

Tkt. No. 1006027288

Product 114203
Bank Run
S.O. Info: Camden, NJ.
Ship Ref: 327 N. Front St



	Pounds	Kilo
Gross	76,680	34,781
Tare	24,640 *	11,177
Net	52,040	23,605

26.02 Ton 23.60

* Predetermined Tare

	UNIT	TOTALS
Material:		
Freight:		
Tax:		
Fee / Fuel:		
Other Chrg: No		

Today Tons:	560.98	Loads:
Tons To Date:	2,391.08	22
Today Tonnes	508.91	
Tonnes To Date:	2,169.15	

Carrier : 2346970 GEORGE LAZOS TRUCKING
Vehicle: LG004 AP213T
License: LG004
MaxGVW: 80,000

By acceptance of this ticket (with or without signature), driver accepts on behalf of themselves/their employer sole responsibility to ensure that the load received is within the weight limit authorized by law and shall hold seller harmless against any and all claims with respect to same CURB DELIVERY ONLY. NOT RESPONSIBLE FOR ANY DAMAGE BEYOND CURB.

Received: _____
Weighmaster: Colleen LeSage

Cust: _____

P/D Status: Deliver

Customer Copy Scale: 1



Plant: 32411

Berlin

368 New Brooklyn Road
Berlin, NJ 08009
856-809-0142

3/8/2017 14:24 In: 14:02:49
Customer: 8638404 THE AMBIENT GROUP LLC
Order: 950949 Camden, NJ. ABC Barrel Project
P.O.:

Tkt. No. 1006027290

Product 114203
Bank Run
S.O. Info: Camden, NJ.
Ship Ref: 327 N. Front St



	Pounds	Kilo
Gross	75,800	34,382
Tare	25,700	11,657
Net	50,100	22,725
	25.05 Ton	22.72

	UNIT	TOTALS
Material:		
Freight:		
Tax:		
Fee / Fuel:		
Other Chrg:	No	

Today Tons:	586.03	Loads:
Tons To Date:	2,416.13	23
Today Tonnes	531.64	
Tonnes To Date:	2,191.88	

Carrier: 2347198 RAIO CONTRACTING & MATE
Vehicle: RO206 AL125T
License: AL125T
MaxGVW: 80,000

By acceptance of this ticket (with or without signature), driver accepts on behalf of themselves/their employer sole responsibility to ensure that the load received is within the weight limit authorized by law and shall hold seller harmless against any and all claims with respect to same CURB DELIVERY ONLY. NOT RESPONSIBLE FOR ANY DAMAGE BEYOND CURB.

Received: _____
Weighmaster: Colleen LeSage

Cust: _____

P/D Status: Deliver

Customer Copy

Scale: 1



Plant: 32411

Berlin

368 New Brooklyn Road
Berlin, NJ 08009
856-809-0142

3/8/2017 14:28 In: 14:12:37
Customer: 8638404 THE AMBIENT GROUP LLC
Order: 950949 Camden, NJ. ABC Barrel Project
P.O.:

Tkt. No. 1006027291

Product 114203
Bank Run
S.O. Info: Camden, NJ.
Ship Ref: 327 N. Front St



	Pounds	Kilo
Gross	77,180	35,008
Tare	27,300	12,383
Net	49,880	22,625
	24.94 Ton	22.63

	UNIT	TOTALS
Material:		
Freight:		
Tax:		
Fee / Fuel:		
Other Chrg:	No	

Today Tons:	610.97	Loads:
Tons To Date:	2,441.07	24
Today Tonnes	554.26	
Tonnes To Date:	2,214.50	

Carrier: 2347198 RAIO CONTRACTING & MATE
Vehicle: RO208 AG820E
License:
MaxGVW: 80,000

By acceptance of this ticket (with or without signature), driver accepts on behalf of themselves/their employer sole responsibility to ensure that the load received is within the weight limit authorized by law and shall hold seller harmless against any and all claims with respect to same CURB DELIVERY ONLY. NOT RESPONSIBLE FOR ANY DAMAGE BEYOND CURB.

Received: _____
Weighmaster: Colleen LeSage

Cust: _____

P/D Status: Deliver

Customer Copy

Scale: 1



Plant: 32411

Berlin

368 New Brooklyn Road
Berlin, NJ 08009
856-809-0142

3/8/2017 14:35 In :
Customer: 8638404 THE AMBIENT GROUP LLC
Order : 950949 Camden, NJ. ABC Barrel Project
P.O. :

Tkt. No. 1006027292

Product 114203
Bank Run
S.O. Info: Camden, NJ.
Ship Ref: 327 N. Front St



	Pounds	Kilo
Gross	78,860	35,770
Tare	28,080 *	12,737
Net	50,780	23,033

25.39 Ton 23.03
* Predetermined Tare

	UNIT	TOTALS
Material:		
Freight:		
Tax:		
Fee / Fuel:		
Other Chrg:	No	

Today Tons:	636.36	Loads:
Tons To Date:	2,466.46	25
Today Tonnes	577.30	
Tonnes To Date:	2,237.53	

Carrier : 8040648 GJ SCOTT LLC
Vehicle: GS16 GS16
License: AT639K
MaxGVW: 80,000

By acceptance of this ticket (with or without signature), driver accepts on behalf of themselves/their employer sole responsibility to ensure that the load received is within the weight limit authorized by law and shall hold seller harmless against any and all claims with respect to same CURB DELIVERY ONLY. NOT RESPONSIBLE FOR ANY DAMAGE BEYOND CURB.

Received: 
Weighmaster: Colleen LeSage

Cust: _____

P/D Status: Deliver

Customer Copy

Scale: 1



Plant: 32411

Berlin

368 New Brooklyn Road
Berlin, NJ 08009
856-809-0142

3/8/2017 14:38 In :
Customer: 8638404 THE AMBIENT GROUP LLC
Order : 950949 Camden, NJ. ABC Barrel Project
P.O. :

Tkt. No. 1006027293

Product 114203
Bank Run
S.O. Info: Camden, NJ.
Ship Ref: 327 N. Front St



	Pounds	Kilo
Gross	78,620	35,661
Tare	28,700 *	13,018
Net	49,920	22,643

24.96 Ton 22.64
* Predetermined Tare

	UNIT	TOTALS
Material:		
Freight:		
Tax:		
Fee / Fuel:		
Other Chrg:	No	

Today Tons:	661.32	Loads:
Tons To Date:	2,491.42	26
Today Tonnes	599.94	
Tonnes To Date:	2,260.18	

Carrier : 8040648 GJ SCOTT LLC
Vehicle: GS14 GS14
License: As672T
MaxGVW: 80,000

By acceptance of this ticket (with or without signature), driver accepts on behalf of themselves/their employer sole responsibility to ensure that the load received is within the weight limit authorized by law and shall hold seller harmless against any and all claims with respect to same CURB DELIVERY ONLY. NOT RESPONSIBLE FOR ANY DAMAGE BEYOND CURB.

Received: _____
Weighmaster: Colleen LeSage

Cust: _____

P/D Status: Deliver

Customer Do Not Accept [2]

Scale: 1



Plant: 32411

Berlin

368 New Brooklyn Road
Berlin, NJ 08009
856-809-0142

3/9/2017 06:51 In: 6:28:46
Customer: 8638404 THE AMBIENT GROUP LLC
Order : 950949 Camden, NJ. ABC Barrel Project
P.O. :

Tkt. No. 1006027294



Product 114203
Bank Run
S.O. Info: Camden, NJ.
Ship Ref: 327 N. Front St

	Pounds	Kilo
Gross	79,680	36,142
Tare	25,820	11,712
Net	53,860	24,430
	26.93 Ton	24.43

	UNIT	TOTALS
Material:		
Freight:		
Tax:		
Fee / Fuel:		
Other Chrg: No		

Today Tons:	26.93	Loads:
Tons To Date:	2,518.35	1
Today Tonnes	24.43	
Tonnes To Date:	2,284.61	

Carrier : 8647386 TURKEYROOST TRANSPORT
Vehicle: TUR001 Turkeyroost
License: AP182A
MaxGVW: 80,000

By acceptance of this ticket (with or without signature), driver accepts on behalf of themselves/their employer sole responsibility to ensure that the load received is within the weight limit authorized by law and shall hold seller harmless against any and all claims with respect to same CURB DELIVERY ONLY. NOT RESPONSIBLE FOR ANY DAMAGE BEYOND CURB.

Received: _____ Cust: _____
Weighmaster: Colleen LeSage

P/D Status: Deliver

Customer Do Not Accept [1] Scale: 1



Plant: 32411

Berlin

368 New Brooklyn Road
Berlin, NJ 08009
856-809-0142

3/9/2017 07:21 In: 7:00:12
Customer: 8638404 THE AMBIENT GROUP LLC
Order : 950949 Camden, NJ. ABC Barrel Project
P.O. :

Tkt. No. 1006027295



Product 114203
Bank Run
S.O. Info: Camden, NJ.
Ship Ref: 327 N. Front St

	Pounds	Kilo
Gross	79,060	35,861
Tare	27,800	12,610
Net	51,260	23,251
	25.63 Ton	23.25

	UNIT	TOTALS
Material:		
Freight:		
Tax:		
Fee / Fuel:		
Other Chrg: No		

Today Tons:	52.56	Loads:
Tons To Date:	2,543.98	2
Today Tonnes	47.68	
Tonnes To Date:	2,307.86	

Carrier : 9249110 CLM CONTRACTING LLC
Vehicle: CLM6 CLM6
License: AT597T
MaxGVW: 80,000

By acceptance of this ticket (with or without signature), driver accepts on behalf of themselves/their employer sole responsibility to ensure that the load received is within the weight limit authorized by law and shall hold seller harmless against any and all claims with respect to same CURB DELIVERY ONLY. NOT RESPONSIBLE FOR ANY DAMAGE BEYOND CURB.

Received: _____ Cust: _____
Weighmaster: Colleen LeSage

P/D Status: Deliver

Customer Do Not Accept [2] Scale: 1



Plant: 32411

Berlin
368 New Brooklyn Road
Berlin, NJ 08009
856-809-0142, ~

3/9/2017 07:23 In :
Customer: 8638404 THE AMBIENT GROUP LLC
Order : 950949 Camden, NJ. ABC Barrel Project
P.O. :

Tkt. No. 1006027296



Product 114203
Bank Run
S.O. Info: Camden, NJ.
Ship Ref: 327 N. Front St

	Pounds	Kilo
Gross	76,080	34,509
Tare	24,660 *	11,186
Net	51,420	23,324
	25.71 Ton	23.32

* Predetermined Tare

	UNIT	TOTALS
Material:		
Freight:		
Tax:		
Fee / Fuel:		
Other Chrg: No		

Today Tons:	78.27	Loads:
Tons To Date:	2,569.69	3
Today Tonnes	71.01	
Tonnes To Date:	2,331.18	

Carrier : 2347198 RAO CONTRACTING & MATE
Vehicle: RO213 Raio
License: AH445F
MaxGVW: 80,000
Received: 
Weighmaster: Colleen LeSage

By acceptance of this ticket (with or without signature), driver accepts on behalf of themselves/their employer sole responsibility to ensure that the load received is within the weight limit authorized by law and shall hold seller harmless against any and all claims with respect to same CURB DELIVERY ONLY. NOT RESPONSIBLE FOR ANY DAMAGE BEYOND CURB.

Cust: _____

P/D Status: Deliver

Customer Do Not Accept [2] Scale: 1



Plant: 32411

Berlin
368 New Brooklyn Road
Berlin, NJ 08009
856-809-0142.

3/9/2017 07:34 In : 7:11:50
Customer: 8638404 THE AMBIENT GROUP LLC
Order : 950949 Camden, NJ. ABC Barrel Project
P.O. :

Tkt. No. 1006027297



Product 114203
Bank Run
S.O. Info: Camden, NJ.
Ship Ref: 327 N. Front St

	Pounds	Kilo
Gross	76,280	34,600
Tare	25,540	11,585
Net	50,740	23,015
	25.37 Ton	23.02

	UNIT	TOTALS
Material:		
Freight:		
Tax:		
Fee / Fuel:		
Other Chrg: No		

Today Tons:	103.64	Loads:
Tons To Date:	2,595.06	4
Today Tonnes	94.02	
Tonnes To Date:	2,354.20	

Carrier : 2347198 RAO CONTRACTING & MATE
Vehicle: RO223 Raio
License: AM608Y
MaxGVW: 80,000
Received: _____
Weighmaster: Colleen LeSage

By acceptance of this ticket (with or without signature), driver accepts on behalf of themselves/their employer sole responsibility to ensure that the load received is within the weight limit authorized by law and shall hold seller harmless against any and all claims with respect to same CURB DELIVERY ONLY. NOT RESPONSIBLE FOR ANY DAMAGE BEYOND CURB.

Cust: _____

P/D Status: Deliver

Customer Copy Scale: 1



Plant: 32411

Berlin
368 New Brooklyn Road
Berlin, NJ 08009
856-809-0142,

3/9/2017 08:01 In: 7:38:20
Customer: 8638404 THE AMBIENT GROUP LLC
Order : 950949 Camden, NJ. ABC Barrel Project
P.O. :

Tkt. No. 1006027302



Product 114203
Bank Run
S.O. Info: Camden, NJ.
Ship Ref: 327 N. Front St

	Pounds	Kilo
Gross	77,900	35,335
Tare	27,220	12,347
Net	50,680	22,988
	25.34 Ton	22.99

UNIT	TOTALS
Material:	
Freight:	
Tax:	
Fee / Fuel:	
Other Chrg: No	

Carrier : 2347198 RAO CONTRACTING & MATE
Vehicle: RO208 AG820E
License:
MaxGVW: 80,000
Received: [Signature]
Weighmaster: Colleen LeSage
P/D Status: Deliver

Today Tons:	128.98	Loads:	
Tons To Date:	2,620.40		5
Today Tonnes	117.01		
Tonnes To Date:	2,377.19		

By acceptance of this ticket (with or without signature), driver accepts on behalf of themselves/their employer sole responsibility to ensure that the load received is within the weight limit authorized by law and shall hold seller harmless against any and all claims with respect to same. CURB DELIVERY ONLY. NOT RESPONSIBLE FOR ANY DAMAGE BEYOND CURB.

Cust: _____

Customer Do Not Accept [3] Scale: 1



Plant: 32411

Berlin
368 New Brooklyn Road
Berlin, NJ 08009
856-809-0142,

3/9/2017 08:26 In :
Customer: 8638404 THE AMBIENT GROUP LLC
Order : 950949 Camden, NJ. ABC Barrel Project
P.O. :

Tkt. No. 1006027307



Product 114203
Bank Run
S.O. Info: Camden, NJ.
Ship Ref: 327 N. Front St

	Pounds	Kilo
Gross	79,060	35,861
Tare	25,820 *	11,712
Net	53,240	24,149
	26.62 Ton	24.15

* Predetermined Tare

UNIT	TOTALS
Material:	
Freight:	
Tax:	
Fee / Fuel:	
Other Chrg: No	

Carrier : 8647386 TURKEYROOST TRANSPORT
Vehicle: TUR001 Turkeyroost
License: AP182A
MaxGVW: 80,000
Received: [Signature]
Weighmaster: Colleen LeSage
P/D Status: Deliver

Today Tons:	155.60	Loads:	
Tons To Date:	2,647.02		6
Today Tonnes	141.16		
Tonnes To Date:	2,401.34		

By acceptance of this ticket (with or without signature), driver accepts on behalf of themselves/their employer sole responsibility to ensure that the load received is within the weight limit authorized by law and shall hold seller harmless against any and all claims with respect to same. CURB DELIVERY ONLY. NOT RESPONSIBLE FOR ANY DAMAGE BEYOND CURB.

Cust: _____

Customer Do Not Accept [2] Scale: 1



Plant: 32411

Berlin

368 New Brooklyn Road
Berlin, NJ 08009
856-809-0142

3/9/2017 08:32 In: 8:15:41
Customer: 8638404 THE AMBIENT GROUP LLC
Order : 950949 Camden, NJ. ABC Barrel Project
P.O. :

Tkt. No. 1006027308

Product 114203
Bank Run
S.O. Info: Camden, NJ.
Ship Ref: 327 N. Front St



	Pounds	Kilo
Gross	75,220	34,119
Tare	24,780	11,240
Net	50,440	22,879

25.22 Ton , 22.88

UNIT	TOTALS
Material:	
Freight:	
Tax:	
Fee / Fuel:	
Other Chrg: No	

Today Tons:	180.82	Loads:
Tons To Date:	2,672.24	7
Today Tonnes	164.04	
Tonnes To Date:	2,424.22	

Carrier : 2347198 RAIO CONTRACTING & MATE
Vehicle: RO225 RAIO
License: AP322C
MaxGVW: 80,000

By acceptance of this ticket (with or without signature), driver accepts on behalf of themselves/their employer sole responsibility to ensure that the load received is within the weight limit authorized by law and shall holdseller harmless against any and all claims with respect to same CURB DELIVERY ONLY. NOT RESPONSIBLE FOR ANY DAMAGE BEYOND CURB.

Received: _____
Weighmaster: Colleen LeSage

Cust: _____

P/D Status: Deliver

Customer Copy

Scale: 1



Plant: 32411

Berlin

368 New Brooklyn Road
Berlin, NJ 08009
856-809-0142

3/9/2017 08:50 In: 8:28:47
Customer: 8638404 THE AMBIENT GROUP LLC
Order : 950949 Camden, NJ. ABC Barrel Project
P.O. :

Tkt. No. 1006027311

Product 114203
Bank Run
S.O. Info: Camden, NJ.
Ship Ref: 327 N. Front St



	Pounds	Kilo
Gross	78,640	35,670
Tare	28,660	13,000
Net	49,980	22,671

24.99 Ton 22.67

UNIT	TOTALS
Material:	
Freight:	
Tax:	
Fee / Fuel:	
Other Chrg: No	

Today Tons:	205.81	Loads:
Tons To Date:	2,697.23	8
Today Tonnes	186.71	
Tonnes To Date:	2,446.89	

Carrier : 8040648 GJ SCOTT LLC
Vehicle: GS14 GS14
License: As672T
MaxGVW: 80,000

By acceptance of this ticket (with or without signature), driver accepts on behalf of themselves/their employer sole responsibility to ensure that the load received is within the weight limit authorized by law and shall holdseller harmless against any and all claims with respect to same CURB DELIVERY ONLY. NOT RESPONSIBLE FOR ANY DAMAGE BEYOND CURB.

Received: _____
Weighmaster: Colleen LeSage

Cust: _____

P/D Status: Deliver

Customer Copy

Scale: 1



Plant: 32411

Berlin

368 New Brooklyn Road
Berlin, NJ 08009
856-809-0142

3/9/2017 08:52 In: 8:29:27
Customer: 8638404 THE AMBIENT GROUP LLC
Order : 950949 Camden, NJ. ABC Barrel Project
P.O. :

Tkt. No. 1006027312

Product 114203
Bank Run
S.O. Info: Camden, NJ.
Ship Ref: 327 N. Front St



	Pounds	Kilo
Gross	75,320	34,165
Tare	24,780	11,240
Net	50,540	22,925

25.27 Ton 22.92

	UNIT	TOTALS
Material:		
Freight:		
Tax:		
Fee / Fuel:		
Other Chrg: No		

Today Tons:	231.08	Loads:
Tons To Date:	2,722.50	9
Today Tonnes	209.63	
Tonnes To Date:	2,469.81	

Carrier : 2347198 RAIO CONTRACTING & MATE
Vehicle: RO219 AJ734F
License: RO219
MaxGVW: 80,000
Received: _____

By acceptance of this ticket (with or without signature), driver accepts on behalf of themselves/their employer sole responsibility to ensure that the load received is within the weight limit authorized by law and shall hold seller harmless against any and all claims with respect to same CURB DELIVERY ONLY. NOT RESPONSIBLE FOR ANY DAMAGE BEYOND CURB.

Weighmaster: Colleen LeSage

Cust: _____

P/D Status: Deliver

Customer Do Not Accept [1] Scale: 1



Plant: 32411

Berlin

368 New Brooklyn Road
Berlin, NJ 08009
856-809-0142

3/9/2017 08:54 In: 8:30:37
Customer: 8638404 THE AMBIENT GROUP LLC
Order : 950949 Camden, NJ. ABC Barrel Project
P.O. :

Tkt. No. 1006027313

Product 114203
Bank Run
S.O. Info: Camden, NJ.
Ship Ref: 327 N. Front St



	Pounds	Kilo
Gross	78,720	35,707
Tare	28,080	12,737
Net	50,640	22,970

25.32 Ton 22.97

	UNIT	TOTALS
Material:		
Freight:		
Tax:		
Fee / Fuel:		
Other Chrg: No		

Today Tons:	256.40	Loads:
Tons To Date:	2,747.82	10
Today Tonnes	232.60	
Tonnes To Date:	2,492.78	

Carrier : 8040648 GJ SCOTT LLC
Vehicle: GS16 GS16
License: AT639K
MaxGVW: 80,000
Received: _____

By acceptance of this ticket (with or without signature), driver accepts on behalf of themselves/their employer sole responsibility to ensure that the load received is within the weight limit authorized by law and shall hold seller harmless against any and all claims with respect to same CURB DELIVERY ONLY. NOT RESPONSIBLE FOR ANY DAMAGE BEYOND CURB.

Weighmaster: Colleen LeSage

Cust: _____

P/D Status: Deliver

Customer Copy Scale: 1



Plant: 32411

Berlin

368 New Brooklyn Road
Berlin, NJ 08009
856-809-0142

3/9/2017 08:56 In: 8:36:02
Customer: 8638404 THE AMBIENT GROUP LLC
Order: 950949 Camden, NJ. ABC Barrel Project
P.O.:

Tkt. No. 1006027314



Product 114203
Bank Run
S.O. Info: Camden, NJ.
Ship Ref: 327 N. Front St

	Pounds	Kilo
Gross	75,800	34,382
Tare	24,580	11,149
Net	51,220	23,233
	25.61 Ton	23.23

	UNIT	TOTALS
Material:		
Freight:		
Tax:		
Fee / Fuel:		
Other Chrg:	No	

Today Tons:	282.01	Loads:
Tons To Date:	2,773.43	11
Today Tonnes	255.84	
Tonnes To Date:	2,516.01	

Carrier: 2347198 RAO CONTRACTING & MATE
Vehicle: RO214 AH505N
License: AH505N
MaxGVW: 80,000
Received: Vine m
Weighmaster: Colleen LeSage

By acceptance of this ticket (with or without signature), driver accepts on behalf of themselves/their employer sole responsibility to ensure that the load received is within the weight limit authorized by law and shall hold seller harmless against any and all claims with respect to same CURB DELIVERY ONLY. NOT RESPONSIBLE FOR ANY DAMAGE BEYOND CURB.

Cust: _____

P/D Status: Deliver

Customer Copy

Scale: 1



Plant: 32411

Berlin

368 New Brooklyn Road
Berlin, NJ 08009
856-809-0142

3/9/2017 09:13 In: _____
Customer: 8638404 THE AMBIENT GROUP LLC
Order: 950949 Camden, NJ. ABC Barrel Project
P.O.:

Tkt. No. 1006027316



Product 114203
Bank Run
S.O. Info: Camden, NJ.
Ship Ref: 327 N. Front St

	Pounds	Kilo
Gross	78,800	35,743
Tare	27,800 *	12,610
Net	51,000	23,133
	25.50 Ton	23.13

* Predetermined Tare

	UNIT	TOTALS
Material:		
Freight:		
Tax:		
Fee / Fuel:		
Other Chrg:	No	

Today Tons:	307.51	Loads:
Tons To Date:	2,798.93	12
Today Tonnes	278.97	
Tonnes To Date:	2,539.15	

Carrier: 9249110 CLM CONTRACTING LLC
Vehicle: CLM6 CLM6
License: AT597T
MaxGVW: 80,000
Received: [Signature]
Weighmaster: Colleen LeSage

By acceptance of this ticket (with or without signature), driver accepts on behalf of themselves/their employer sole responsibility to ensure that the load received is within the weight limit authorized by law and shall hold seller harmless against any and all claims with respect to same CURB DELIVERY ONLY. NOT RESPONSIBLE FOR ANY DAMAGE BEYOND CURB.

Cust: _____

P/D Status: Deliver

Customer Copy

Scale: 1



Plant: 32411

Berlin
368 New Brooklyn Road
Berlin, NJ 08009
856-809-0142

3/9/2017 09:34 In :
Customer: 8638404 THE AMBIENT GROUP LLC
Order : 950949 Camden, NJ. ABC Barrel Project
P.O. :

Tkt. No. 1006027317



Product 114203
Bank Run
S.O. Info: Camden, NJ.
Ship Ref: 327 N. Front St

	Pounds	Kilo
Gross	78,160	35,453
Tare	27,220 *	12,347
Net	50,940	23,106
	25.47 Ton	23.11

* Predetermined Tare

	UNIT	TOTALS
Material:		
Freight:		
Tax:		
Fee / Fuel:		
Other Chrg: No		

Today Tons:	332.98	Loads:
Tons To Date:	2,824.40	13
Today Tonnes	302.07	
Tonnes To Date:	2,562.25	

Carrier : 2347198 RAIO CONTRACTING & MATE
Vehicle: RO208 AG820E
License:
MaxGVW: ~~80,000~~
Received: 2208
Weighmaster: Colleen LeSage
P/D Status: Deliver

By acceptance of this ticket (with or without signature), driver accepts on behalf of themselves/their employer sole responsibility to ensure that the load received is within the weight limit authorized by law and shall hold seller harmless against any and all claims with respect to same CURB DELIVERY ONLY. NOT RESPONSIBLE FOR ANY DAMAGE BEYOND CURB.

Cust: _____

Customer Do Not Accept [2] Scale: 1



Plant: 32411

Berlin
368 New Brooklyn Road
Berlin, NJ 08009
856-809-0142

3/9/2017 09:53 In : 9:34:10
Customer: 8638404 THE AMBIENT GROUP LLC
Order : 950949 Camden, NJ. ABC Barrel Project
P.O. :

Tkt. No. 1006027319



Product 114203
Bank Run
S.O. Info: Camden, NJ.
Ship Ref: 327 N. Front St

	Pounds	Kilo
Gross	76,540	34,718
Tare	26,900	12,202
Net	49,640	22,516
	24.82 Ton	22.52

	UNIT	TOTALS
Material:		
Freight:		
Tax:		
Fee / Fuel:		
Other Chrg: No		

Today Tons:	357.80	Loads:
Tons To Date:	2,849.22	14
Today Tonnes	324.59	
Tonnes To Date:	2,584.77	

Carrier : 2347198 RAIO CONTRACTING & MATE
Vehicle: RO209 AL124T
License: AL124T
MaxGVW: ~~80,000~~
Received: [Signature]
Weighmaster: Colleen LeSage
P/D Status: Deliver

By acceptance of this ticket (with or without signature), driver accepts on behalf of themselves/their employer sole responsibility to ensure that the load received is within the weight limit authorized by law and shall hold seller harmless against any and all claims with respect to same CURB DELIVERY ONLY. NOT RESPONSIBLE FOR ANY DAMAGE BEYOND CURB.

Cust: _____

Customer Copy Scale: 1



Plant: 32411

Berlin
368 New Brooklyn Road
Berlin, NJ 08009
856-809-0142

3/9/2017 09:56 In :
Customer: 8638404 THE AMBIENT GROUP LLC
Order : 950949 Camden, NJ. ABC Barrel Project
P.O. :

Tkt. No. 1006027320



Product 114203
Bank Run
S.O. Info: Camden, NJ.
Ship Ref: 327 N. Front St

	Pounds	Kilo
Gross	78,800	35,743
Tare	25,820 *	11,712
Net	52,980	24,031

26.49 Ton 24.03

* Predetermined Tare

Today Tons:	384.29	Loads:
Tons To Date:	2,875.71	15
Today Tonnes	348.62	
Tonnes To Date:	2,608.80	

By acceptance of this ticket (with or without signature), driver accepts on behalf of themselves/their employer sole responsibility to ensure that the load received is within the weight limit authorized by law and shall hold seller harmless against any and all claims with respect to same CURB DELIVERY ONLY. NOT RESPONSIBLE FOR ANY DAMAGE BEYOND CURB.

UNIT	TOTALS
Material:	
Freight:	
Tax:	
Fee / Fuel:	
Other Chrg: No	

Carrier : 8647386 TURKEYROOST TRANSPORT
Vehicle: TUR001 Turkeyroost
License: AP182A
MaxGVW: 80,000

Received: _____ Cust: _____
Weighmaster: Colleen LeSage

P/D Status: Deliver

Customer Do Not Accept [3] Scale: 1



Plant: 32411

Berlin
368 New Brooklyn Road
Berlin, NJ 08009
856-809-0142

3/9/2017 10:33 In : 10:04:36
Customer: 8638404 THE AMBIENT GROUP LLC
Order : 950949 Camden, NJ. ABC Barrel Project
P.O. :

Tkt. No. 1006027322



Product 114203
Bank Run
S.O. Info: Camden, NJ.
Ship Ref: 327 N. Front St

	Pounds	Kilo
Gross	76,180	34,555
Tare	24,980	11,331
Net	51,200	23,224

25.60 Ton 23.22

Today Tons:	409.89	Loads:
Tons To Date:	2,901.31	16
Today Tonnes	371.85	
Tonnes To Date:	2,632.02	

By acceptance of this ticket (with or without signature), driver accepts on behalf of themselves/their employer sole responsibility to ensure that the load received is within the weight limit authorized by law and shall hold seller harmless against any and all claims with respect to same CURB DELIVERY ONLY. NOT RESPONSIBLE FOR ANY DAMAGE BEYOND CURB.

UNIT	TOTALS
Material:	
Freight:	
Tax:	
Fee / Fuel:	
Other Chrg: No	

Carrier : 2347198 RAOI CONTRACTING & MATE
Vehicle: RO222 AK269E
License: AK269e
MaxGVW: 80,000

Received: _____ Cust: _____
Weighmaster: Colleen LeSage

P/D Status: Deliver

Customer Copy Scale: 1



Plant: 32411

Berlin

368 New Brooklyn Road
Berlin, NJ 08009
856-809-0142

3/9/2017 10:35 In :
Customer: 8638404 THE AMBIENT GROUP LLC
Order : 950949 Camden, NJ. ABC Barrel Project
P.O. :

Tkt. No. 1006027323



Product 114203
Bank Run
S.O. Info: Camden, NJ.
Ship Ref: 327 N. Front St

	Pounds	Kilo
Gross	75,360	34,183
Tare	24,780 *	11,240
Net	50,580	22,943

25.29 Ton 22.94
* Predetermined Tare

UNIT	TOTALS
Material:	
Freight:	
Tax:	
Fee / Fuel:	
Other Chrg: No	

Today Tons:	435.18	Loads:
Tons To Date:	2,926.60	17
Today Tonnes	394.79	
Tonnes To Date:	2,654.97	

By acceptance of this ticket (with or without signature), driver accepts on behalf of themselves/their employer sole responsibility to ensure that the load received is within the weight limit authorized by law and shall hold seller harmless against any and all claims with respect to same CURB DELIVERY ONLY. NOT RESPONSIBLE FOR ANY DAMAGE BEYOND CURB.

Carrier : 2347198 RAO CONTRACTING & MATE
Vehicle: RO225 RAO
License: AP322C
MaxGVW: 80,000

Received: _____ Cust: _____

Weighmaster: Colleen LeSage

P/D Status: Deliver

Customer Copy

Scale: 1



Plant: 32411

Berlin

368 New Brooklyn Road
Berlin, NJ 08009
856-809-0142

3/9/2017 10:37 In :
Customer: 8638404 THE AMBIENT GROUP LLC
Order : 950949 Camden, NJ. ABC Barrel Project
P.O. :

Tkt. No. 1006027324



Product 114203
Bank Run
S.O. Info: Camden, NJ.
Ship Ref: 327 N. Front St

	Pounds	Kilo
Gross	77,340	35,081
Tare	27,800 *	12,610
Net	49,540	22,471

24.77 Ton 22.47
* Predetermined Tare

UNIT	TOTALS
Material:	
Freight:	
Tax:	
Fee / Fuel:	
Other Chrg: No	

Today Tons:	459.95	Loads:
Tons To Date:	2,951.37	18
Today Tonnes	417.26	
Tonnes To Date:	2,677.44	

By acceptance of this ticket (with or without signature), driver accepts on behalf of themselves/their employer sole responsibility to ensure that the load received is within the weight limit authorized by law and shall hold seller harmless against any and all claims with respect to same CURB DELIVERY ONLY. NOT RESPONSIBLE FOR ANY DAMAGE BEYOND CURB.

Carrier : 9249110 CLM CONTRACTING LLC
Vehicle: CLM6 CLM6
License: AT597T
MaxGVW: 80,000

Received: _____ Cust: _____

Weighmaster: Colleen LeSage

P/D Status: Deliver

Customer Do Not Accept [1]

Scale: 1



Plant: 32411

Berlin

368 New Brooklyn Road
Berlin, NJ 08009
856-809-0142

3/9/2017 10:50

In :

Customer: 8638404 THE AMBIENT GROUP LLC

Order : 950949 Camden, NJ. ABC Barrel Project

P.O. :

Tkt. No. 1006027325

Product 114203

Bank Run

S.O. Info: Camden, NJ.

Ship Ref: 327 N. Front St



	Pounds	Kilo
Gross	79,440	36,033
Tare	28,660 *	13,000
Net	50,780	23,033

25.39 Ton 23.03

* Predetermined Tare

Today Tons:	485.34	Loads:
Tons To Date:	2,976.76	19
Today Tonnes	440.29	
Tonnes To Date:	2,700.47	

	UNIT	TOTALS
Material:		
Freight:		
Tax:		
Fee / Fuel:		
Other Chrg:	No	

By acceptance of this ticket (with or without signature), driver accepts on behalf of themselves/their employer sole responsibility to ensure that the load received is within the weight limit authorized by law and shall hold seller harmless against any and all claims with respect to same CURB DELIVERY ONLY. NOT RESPONSIBLE FOR ANY DAMAGE BEYOND CURB.

Carrier : 8040648 GJ SCOTT LLC

Vehicle: GS14 GS14

License: As672T

MaxGVW: 80,000

Received:

Weighmaster: Colleen LeSage

Cust: _____

P/D Status: Deliver

Customer Copy

Scale: 1



Plant: 32411

Berlin

368 New Brooklyn Road
Berlin, NJ 08009
856-809-0142

3/9/2017 11:12

In :

Customer: 8638404 THE AMBIENT GROUP LLC

Order : 950949 Camden, NJ. ABC Barrel Project

P.O. :

Tkt. No. 1006027328

Product 114203

Bank Run

S.O. Info: Camden, NJ.

Ship Ref: 327 N. Front St



	Pounds	Kilo
Gross	77,560	35,181
Tare	27,220 *	12,347
Net	50,340	22,834

25.17 Ton 22.83

* Predetermined Tare

Today Tons:	510.51	Loads:
Tons To Date:	3,001.93	20
Today Tonnes	463.13	
Tonnes To Date:	2,723.31	

	UNIT	TOTALS
Material:		
Freight:		
Tax:		
Fee / Fuel:		
Other Chrg:	No	

By acceptance of this ticket (with or without signature), driver accepts on behalf of themselves/their employer sole responsibility to ensure that the load received is within the weight limit authorized by law and shall hold seller harmless against any and all claims with respect to same CURB DELIVERY ONLY. NOT RESPONSIBLE FOR ANY DAMAGE BEYOND CURB.

Carrier : 2347198 RAIO CONTRACTING & MATE

Vehicle: RO208 AG820E

License:

MaxGVW: 80,000

Received:

Weighmaster: Colleen LeSage

Cust: _____

P/D Status: Deliver

Customer Do Not Accept [2]

Scale: 1



Plant: 32411

Berlin
368 New Brooklyn Road
Berlin, NJ 08009
856-809-0142

3/9/2017 11:18 In:
Customer: 8638404 THE AMBIENT GROUP LLC
Order : 950949 Camden, NJ. ABC Barrel Project
P.O. :

Tkt. No. 1006027329

Product 114203
Bank Run
S.O. Info: Camden, NJ.
Ship Ref: 327 N. Front St



	Pounds	Kilo
Gross	77,940	35,353
Tare	28,080 *	12,737
Net	49,860	22,616

24.93 Ton 22.62
* Predetermined Tare

Today Tons:	535.44	Loads:
Tons To Date:	3,026.86	21
Today Tonnes	485.74	
Tonnes To Date:	2,745.92	

UNIT	TOTALS
Material:	
Freight:	
Tax:	
Fee / Fuel:	
Other Chrg: No	

By acceptance of this ticket (with or without signature), driver accepts on behalf of themselves/their employer sole responsibility to ensure that the load received is within the weight limit authorized by law and shall hold seller harmless against any and all claims with respect to same CURB DELIVERY ONLY. NOT RESPONSIBLE FOR ANY DAMAGE BEYOND CURB.

Carrier : 8040648 GJ SCOTT LLC
Vehicle: GS16 GS16
License: AT639K
MaxGVW: 80,000
Received: _____
Weighmaster: Colleen LeSage

Cust: _____

P/D Status: Deliver

Customer Do Not Accept [2] Scale: 1



Plant: 32411

Berlin
368 New Brooklyn Road
Berlin, NJ 08009
856-809-0142

3/9/2017 11:24 In:
Customer: 8638404 THE AMBIENT GROUP LLC
Order : 950949 Camden, NJ. ABC Barrel Project
P.O. :

Tkt. No. 1006027330

Product 114203
Bank Run
S.O. Info: Camden, NJ.
Ship Ref: 327 N. Front St



	Pounds	Kilo
Gross	76,840	34,854
Tare	26,900 *	12,202
Net	49,940	22,652

24.97 Ton 22.65
* Predetermined Tare

Today Tons:	560.41	Loads:
Tons To Date:	3,051.83	22
Today Tonnes	508.40	
Tonnes To Date:	2,768.57	

UNIT	TOTALS
Material:	
Freight:	
Tax:	
Fee / Fuel:	
Other Chrg: No	

By acceptance of this ticket (with or without signature), driver accepts on behalf of themselves/their employer sole responsibility to ensure that the load received is within the weight limit authorized by law and shall hold seller harmless against any and all claims with respect to same CURB DELIVERY ONLY. NOT RESPONSIBLE FOR ANY DAMAGE BEYOND CURB.

Carrier : 2347198 RAO CONTRACTING & MATE
Vehicle: RO209 AL124T
License: AL124T
MaxGVW: 80,000
Received: _____
Weighmaster: Colleen LeSage

Cust: _____

P/D Status: Deliver

Customer Do Not Accept [2] Scale: 1



Plant: 32411

Berlin
368 New Brooklyn Road
Berlin, NJ 08009
856-809-0142

3/9/2017 12:01 In:
Customer: 8638404 THE AMBIENT GROUP LLC
Order : 950949 Camden, NJ. ABC Barrel Project
P.O. :

Tkt. No. 1006027335

Product 114203
Bank Run
S.O. Info: Camden, NJ.
Ship Ref: 327 N. Front St



	Pounds	Kilo
Gross	75,980	34,464
Tare	24,780 *	11,240
Net	51,200	23,224

25.60 Ton 23.22

* Predetermined Tare

Material:	UNIT	TOTALS
Freight:		
Tax:		
Fee / Fuel:		
Other Chrg: No		

Today Tons:	586.01	Loads:
Tons To Date:	3,077.43	23
Today Tonnes	531.62	
Tonnes To Date:	2,791.80	

Carrier : 2347198 RAIO CONTRACTING & MATE
Vehicle: RO225 RAIO
License: AP322C
MaxGVW: 80,000

By acceptance of this ticket (with or without signature), driver accepts on behalf of themselves/their employer sole responsibility to ensure that the load received is within the weight limit authorized by law and shall hold seller harmless against any and all claims with respect to same CURB DELIVERY ONLY. NOT RESPONSIBLE FOR ANY DAMAGE BEYOND CURB.

Received: _____ Cust: _____

Weighmaster: Colleen LeSage

P/D Status: Deliver

Customer Do Not Accept [2] Scale: 1



Plant: 32411

Berlin
368 New Brooklyn Road
Berlin, NJ 08009
856-809-0142

3/9/2017 12:05 In:
Customer: 8638404 THE AMBIENT GROUP LLC
Order : 950949 Camden, NJ. ABC Barrel Project
P.O. :

Tkt. No. 1006027336

Product 114203
Bank Run
S.O. Info: Camden, NJ.
Ship Ref: 327 N. Front St



	Pounds	Kilo
Gross	78,940	35,807
Tare	27,800 *	12,610
Net	51,140	23,197

25.57 Ton 23.20

* Predetermined Tare

Material:	UNIT	TOTALS
Freight:		
Tax:		
Fee / Fuel:		
Other Chrg: No		

Today Tons:	611.58	Loads:
Tons To Date:	3,103.00	24
Today Tonnes	554.82	
Tonnes To Date:	2,814.99	

Carrier : 9249110 CLM CONTRACTING LLC
Vehicle: CLM6 CLM6
License: AT597T
MaxGVW: 80,000

By acceptance of this ticket (with or without signature), driver accepts on behalf of themselves/their employer sole responsibility to ensure that the load received is within the weight limit authorized by law and shall hold seller harmless against any and all claims with respect to same CURB DELIVERY ONLY. NOT RESPONSIBLE FOR ANY DAMAGE BEYOND CURB.

Received: _____ Cust: _____

Weighmaster: Colleen LeSage

P/D Status: Deliver

Customer Copy Scale: 1



Plant: 32411

Berlin

368 New Brooklyn Road
Berlin, NJ 08009
856-809-0142.

3/9/2017 12:50

In :

Customer: 8638404 THE AMBIENT GROUP LLC

Order : 950949 Camden, NJ. ABC Barrel Project

P.O. :

Tkt. No. 1006027341

Product 114203



Bank Run

S.O. Info: Camden, NJ.

Ship Ref: 327 N. Front St

	Pounds	Kilo
Gross	69,280	31,425
Tare	27,220 *	12,347
Net	42,060	19,078

21.03 Ton 19.08

* Predetermined Tare

Material:	UNIT	TOTALS
Freight:		
Tax:		
Fee / Fuel:		
Other Chrg: No		

Today Tons:	632.61	Loads:
Tons To Date:	3,124.03	25
Today Tonnes	573.89	
Tonnes To Date:	2,834.07	

Carrier : 2347198 RAIO CONTRACTING & MATE

Vehicle: RO208 AG820E

License:

MaxGVW: 80,000

Received:

Weighmaster: Colleen LeSage

P/D Status: Deliver

By acceptance of this ticket (with or without signature), driver accepts on behalf of themselves/their employer sole responsibility to ensure that the load received is within the weight limit authorized by law and shall hold seller harmless against any and all claims with respect to same CURB DELIVERY ONLY. NOT RESPONSIBLE FOR ANY DAMAGE BEYOND CURB.

Cust: _____

Customer Do Not Accept [1] Scale: 1



Plant: 32411

Berlin

368 New Brooklyn Road
Berlin, NJ 08009
856-809-0142.

3/9/2017 12:56

In : 12:13:10

Customer: 8638404 THE AMBIENT GROUP LLC

Order : 950949 Camden, NJ. ABC Barrel Project

P.O. :

Tkt. No. 1006027342

Product 114203



Bank Run

S.O. Info: Camden, NJ.

Ship Ref: 327 N. Front St

	Pounds	Kilo
Gross	79,920	36,251
Tare	25,620	11,621
Net	54,300	24,630

27.15 Ton 24.63

Material:	UNIT	TOTALS
Freight:		
Tax:		
Fee / Fuel:		
Other Chrg: No		

Today Tons:	659.76	Loads:
Tons To Date:	3,151.18	26
Today Tonnes	598.52	
Tonnes To Date:	2,858.70	

Carrier : 8647386 TURKEYROOST TRANSPORT

Vehicle: TUR001 Turkeyroost

License: AP182A

MaxGVW: 80,000

Received:

Weighmaster: Colleen LeSage

P/D Status: Deliver

Cust: _____

Customer Do Not Accept [3] Scale: 1

By acceptance of this ticket (with or without signature), driver accepts on behalf of themselves/their employer sole responsibility to ensure that the load received is within the weight limit authorized by law and shall hold seller harmless against any and all claims with respect to same CURB DELIVERY ONLY. NOT RESPONSIBLE FOR ANY DAMAGE BEYOND CURB.



Plant: 32411

Berlin

368 New Brooklyn Road
Berlin, NJ 08009
856-809-0142

3/9/2017 12:58 In:
Customer: 8638404 THE AMBIENT GROUP LLC
Order : 950949 Camden, NJ. ABC Barrel Project
P.O. :

Tkt. No. 1006027343

Product 114203
Bank Run
S.O. Info: Camden, NJ.
Ship Ref: 327 N. Front St



	Pounds	Kilo
Gross	75,420	34,210
Tare	28,660 *	13,000
Net	46,760	21,210

23.38 Ton 21.21

* Predetermined Tare

	UNIT	TOTALS
Material:		
Freight:		
Tax:		
Fee / Fuel:		
Other Chrg: No		

Today Tons:	683.14	Loads:
Tons To Date:	3,174.56	27
Today Tonnes	619.73	
Tonnes To Date:	2,879.91	

Carrier : 8040648 GJ SCOTT LLC
Vehicle: GS14 GS14
License: As672T
MaxGVW: 80,000

By acceptance of this ticket (with or without signature), driver accepts on behalf of themselves/their employer sole responsibility to ensure that the load received is within the weight limit authorized by law and shall hold seller harmless against any and all claims with respect to same CURB DELIVERY ONLY. NOT RESPONSIBLE FOR ANY DAMAGE BEYOND CURB.

Received: _____
Weighmaster: Colleen LeSage

Cust: _____

P/D Status: Deliver

Customer Copy

Scale: 1



Plant: 32411

Berlin

368 New Brooklyn Road
Berlin, NJ 08009
856-809-0142

3/9/2017 13:12 In:
Customer: 8638404 THE AMBIENT GROUP LLC
Order : 950949 Camden, NJ. ABC Barrel Project
P.O. :

Tkt. No. 1006027345

Product 114203
Bank Run
S.O. Info: Camden, NJ.
Ship Ref: 327 N. Front St



	Pounds	Kilo
Gross	71,600	32,477
Tare	26,900 *	12,202
Net	44,700	20,276

22.35 Ton 20.28

* Predetermined Tare

	UNIT	TOTALS
Material:		
Freight:		
Tax:		
Fee / Fuel:		
Other Chrg: No		

Today Tons:	705.49	Loads:
Tons To Date:	3,196.91	28
Today Tonnes	640.01	
Tonnes To Date:	2,900.19	

Carrier : 2347198 RAIO CONTRACTING & MATE
Vehicle: RO209 AL124T
License: AL124T
MaxGVW: 80,000

By acceptance of this ticket (with or without signature), driver accepts on behalf of themselves/their employer sole responsibility to ensure that the load received is within the weight limit authorized by law and shall hold seller harmless against any and all claims with respect to same CURB DELIVERY ONLY. NOT RESPONSIBLE FOR ANY DAMAGE BEYOND CURB.

Received: _____
Weighmaster: Colleen LeSage

Cust: _____

P/D Status: Deliver

Customer Copy

Scale: 1



Plant: 32411

Berlin

368 New Brooklyn Road
Berlin, NJ 08009
856-809-0142

3/9/2017 13:40

In :

Customer: 8638404 THE AMBIENT GROUP LLC

Order : 950949 Camden, NJ. ABC Barrel Project

P.O. :

Tkt. No. 1006027347

Product 114203



Bank Run

S.O. Info: Camden, NJ.

Ship Ref: 327 N. Front St

	Pounds	Kilo
Gross	78,340	35,534
Tare	27,800 *	12,610
Net	50,540	22,925

25.27 Ton 22.92

* Predetermined Tare

Material:	UNIT	TOTALS
Freight:		
Tax:		
Fee / Fuel:		
Other Chrg: No		

Today Tons:	730.76	Loads:
Tons To Date:	3,222.18	29
Today Tonnes	662.93	
Tonnes To Date:	2,923.11	

Carrier : 9249110 CLM CONTRACTING LLC

Vehicle: CLM6 CLM6

License: AT597T

MaxGVW: 80,000

Received: _____

Weighmaster: Colleen LeSage

Cust: _____

P/D Status: Deliver

Customer Do Not Accept [1] Scale: 1

By acceptance of this ticket (with or without signature), driver accepts on behalf of themselves/their employer sole responsibility to ensure that the load received is within the weight limit authorized by law and shall hold seller harmless against any and all claims with respect to same CURB DELIVERY ONLY. NOT RESPONSIBLE FOR ANY DAMAGE BEYOND CURB.



Plant: 32411

Berlin

368 New Brooklyn Road
Berlin, NJ 08009
856-809-0142

3/9/2017 13:42

In :

Customer: 8638404 THE AMBIENT GROUP LLC

Order : 950949 Camden, NJ. ABC Barrel Project

P.O. :

Tkt. No. 1006027348

Product 114203



Bank Run

S.O. Info: Camden, NJ.

Ship Ref: 327 N. Front St

	Pounds	Kilo
Gross	75,880	34,419
Tare	24,780 *	11,240
Net	51,100	23,179

25.55 Ton 23.18

* Predetermined Tare

Material:	UNIT	TOTALS
Freight:		
Tax:		
Fee / Fuel:		
Other Chrg: No		

Today Tons:	756.31	Loads:
Tons To Date:	3,247.73	30
Today Tonnes	686.11	
Tonnes To Date:	2,946.29	

Carrier : 2347198 RAIO CONTRACTING & MATE

Vehicle: RO225 RAIO

License: AP322C

MaxGVW: 80,000

Received: _____

Weighmaster: Colleen LeSage

Cust: _____

P/D Status: Deliver

Customer Copy Scale: 1

By acceptance of this ticket (with or without signature), driver accepts on behalf of themselves/their employer sole responsibility to ensure that the load received is within the weight limit authorized by law and shall hold seller harmless against any and all claims with respect to same CURB DELIVERY ONLY. NOT RESPONSIBLE FOR ANY DAMAGE BEYOND CURB.



Plant: 32411

Berlin

368 New Brooklyn Road
Berlin, NJ 08009
856-809-0142

3/9/2017 14:19 In :
Customer: 8638404 THE AMBIENT GROUP LLC
Order : 950949 Camden, NJ. ABC Barrel Project
P.O. :

Tkt. No. 1006027352



Product 114203
Bank Run
S.O. Info: Camden, NJ.
Ship Ref: 327 N. Front St

	Pounds	Kilo
Gross	79,160	35,906
Tare	25,620 *	11,621
Net	53,540	24,285

26.77 Ton 24.29
* Predetermined Tare

	UNIT	TOTALS
Material:		
Freight:		
Tax:		
Fee / Fuel:		
Other Chrg: No		

Today Tons:	833.28	Loads:
Tons To Date:	3,324.70	33
Today Tonnes	755.94	
Tonnes To Date:	3,016.12	

Carrier : 8647386 TURKEYROOST TRANSPORT
Vehicle: TUR001 Turkeyroost
License: AP182A
MaxGVW: 80,000

By acceptance of this ticket (with or without signature), driver accepts on behalf of themselves/their employer sole responsibility to ensure that the load received is within the weight limit authorized by law and shall hold self harmless against any and all claims with respect to same CURB DELIVERY ONLY. NOT RESPONSIBLE FOR ANY DAMAGE BEYOND CURB.

Received: _____ Cust: _____
Weighmaster: Colleen LeSage

P/D Status: Deliver

Customer Copy

Scale: 1



Plant: 32411

Berlin

368 New Brooklyn Road
Berlin, NJ 08009
856-809-0142

3/9/2017 13:47 In :
Customer: 8638404 THE AMBIENT GROUP LLC
Order : 950949 Camden, NJ. ABC Barrel Project
P.O. :

Tkt. No. 1006027349

Product 114203
Bank Run
S.O. Info: Camden, NJ.
Ship Ref: 327 N. Front St



	Pounds	Kilo
Gross	78,960	35,816
Tare	28,080 *	12,737
Net	50,880	23,079

25.44 Ton 23.08
* Predetermined Tare

	UNIT	TOTALS
Material:		
Freight:		
Tax:		
Fee / Fuel:		
Other Chrg: No		

Today Tons:	781.75	Loads:
Tons To Date:	3,273.17	31
Today Tonnes	709.19	
Tonnes To Date:	2,969.37	

Carrier : 8040648 GJ SCOTT LLC
Vehicle: GS16 GS16
License: AT639K
MaxGVW: 80,000

By acceptance of this ticket (with or without signature), driver accepts on behalf of themselves/their employer sole responsibility to ensure that the load received is within the weight limit authorized by law and shall hold seller harmless against any and all claims with respect to same CURB DELIVERY ONLY. NOT RESPONSIBLE FOR ANY DAMAGE BEYOND CURB.

Received: _____
Weighmaster: Colleen LeSage

Cust: _____

P/D Status: Deliver

Customer Copy Scale: 1



Plant: 32411

Berlin

368 New Brooklyn Road
Berlin, NJ 08009
856-809-0142

3/9/2017 14:09 In : 13:52:21
Customer: 8638404 THE AMBIENT GROUP LLC
Order : 950949 Camden, NJ. ABC Barrel Project
P.O. :

Tkt. No. 1006027351

Product 114203
Bank Run
S.O. Info: Camden, NJ.
Ship Ref: 327 N. Front St



	Pounds	Kilo
Gross	76,740	34,809
Tare	27,220	12,347
Net	49,520	22,462

24.76 Ton 22.46

	UNIT	TOTALS
Material:		
Freight:		
Tax:		
Fee / Fuel:		
Other Chrg: No		

Today Tons:	806.51	Loads:
Tons To Date:	3,297.93	32
Today Tonnes	731.65	
Tonnes To Date:	2,991.83	

Carrier : 8040648 GJ SCOTT LLC
Vehicle: GS9 GS9
License: AK587X
MaxGVW: 80,000

By acceptance of this ticket (with or without signature), driver accepts on behalf of themselves/their employer sole responsibility to ensure that the load received is within the weight limit authorized by law and shall hold seller harmless against any and all claims with respect to same CURB DELIVERY ONLY. NOT RESPONSIBLE FOR ANY DAMAGE BEYOND CURB.

Received: _____
Weighmaster: Colleen LeSage

Cust: _____

P/D Status: Deliver

Customer Do Not Accept [2] Scale: 1



Plant: 32411

Berlin

368 New Brooklyn Road
Berlin, NJ 08009
856-809-0142

3/9/2017 14:26

In :

Customer: 8638404 THE AMBIENT GROUP LLC

Order : 950949 Camden, NJ. ABC Barrel Project

P.O. :

Tkt. No. 1006027353

Product 114203



Bank Run

S.O. Info: Camden, NJ.

Ship Ref: 327 N. Front St

	Pounds	Kilo
Gross	79,300	35,970
Tare	28,660 *	13,000
Net	50,640	22,970

25.32 Ton 22.97

* Predetermined Tare

	UNIT	TOTALS
Material:		
Freight:		
Tax:		
Fee / Fuel:		
Other Chrg: No		

Today Tons:	858.60	Loads:
Tons To Date:	3,350.02	34
Today Tonnes	778.91	
Tonnes To Date:	3,039.09	

Carrier : 8040648 GJ SCOTT LLC

Vehicle: GS14 GS14

License: As6727

MaxGVW: 80,000

Received:

Weighmaster: Colleen LeSage

Cust: _____

P/D Status: Deliver

By acceptance of this ticket (with or without signature), driver accepts on behalf of themselves/their employer sole responsibility to ensure that the load received is within the weight limit authorized by law and shall hold seller harmless against any and all claims with respect to same CURB DELIVERY ONLY. NOT RESPONSIBLE FOR ANY DAMAGE BEYOND CURB.

Customer Do Not Accept [1] Scale: 1



Plant: 32411

Berlin

368 New Brooklyn Road
Berlin, NJ 08009
856-809-0142

3/10/2017 07:18

In : 6:47:50

Customer: 8638404 THE AMBIENT GROUP LLC

Order : 950949 Camden, NJ. ABC Barrel Project

P.O. :

Tkt. No. 1006027356

Product 114203



Bank Run

S.O. Info: Camden, NJ.

Ship Ref: 327 N. Front St

	Pounds	Kilo
Gross	78,660	35,680
Tare	27,680	12,555
Net	50,980	23,124

25.49 Ton 23.12

	UNIT	TOTALS
Material:		
Freight:		
Tax:		
Fee / Fuel:		
Other Chrg: No		

Today Tons:	25.49	Loads:
Tons To Date:	3,375.51	1
Today Tonnes	23.12	
Tonnes To Date:	3,062.21	

Carrier : 8040648 GJ SCOTT LLC

Vehicle: GS4 GS4

License: AJ118L

MaxGVW: 80,000

Received:

Weighmaster: Colleen LeSage

Cust: _____

P/D Status: Deliver

By acceptance of this ticket (with or without signature), driver accepts on behalf of themselves/their employer sole responsibility to ensure that the load received is within the weight limit authorized by law and shall hold seller harmless against any and all claims with respect to same CURB DELIVERY ONLY. NOT RESPONSIBLE FOR ANY DAMAGE BEYOND CURB.

Customer Do Not Accept [2] Scale: 1



Plant: 32411

Berlin

368 New Brooklyn Road
Berlin, NJ 08009
856-809-0142

3/10/2017 07:21 In: 6:34:24
Customer: 8638404 THE AMBIENT GROUP LLC
Order: 950949 Camden, NJ. ABC Barrel Project
P.O.:

Tkt. No. 1006027357

Product 114203
Bank Run
S.O. Info: Camden, NJ.
Ship Ref: 327 N. Front St



	Pounds	Kilo
Gross	79,140	35,897
Tare	27,860	12,637
Net	51,280	23,260
	25.64 Ton	23.26

	UNIT	TOTALS
Material:		
Freight:		
Tax:		
Fee / Fuel:		
Other Chrg: No		

Today Tons:	51.13	Loads:
Tons To Date:	3,401.15	2
Today Tonnes	46.38	
Tonnes To Date:	3,085.47	

By acceptance of this ticket (with or without signature), driver accepts on behalf of themselves/their employer sole responsibility to ensure that the load received is within the weight limit authorized by law and shall hold seller harmless against any and all claims with respect to same
CURB DELIVERY ONLY. NOT RESPONSIBLE FOR ANY DAMAGE BEYOND CURB.

Carrier: 9249110 CLM CONTRACTING LLC
Vehicle: CLM6 CLM6
License: AT597T
MaxGVW: 80,000

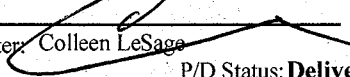
Received: 
Weighmaster: Colleen LeSage
Cust: _____
P/D Status: Deliver

Customer Do Not Accept [3] Scale: 1



Plant: 32411

Berlin

368 New Brooklyn Road
Berlin, NJ 08009
856-809-0142

3/10/2017 07:51 In: 7:27:19
Customer: 8638404 THE AMBIENT GROUP LLC
Order: 950949 Camden, NJ. ABC Barrel Project
P.O.:

Tkt. No. 1006027358

Product 114203
Bank Run
S.O. Info: Camden, NJ.
Ship Ref: 327 N. Front St



	Pounds	Kilo
Gross	78,860	35,770
Tare	28,640	12,991
Net	50,220	22,779
	25.11 Ton	22.78

	UNIT	TOTALS
Material:		
Freight:		
Tax:		
Fee / Fuel:		
Other Chrg: No		

Today Tons:	76.24	Loads:
Tons To Date:	3,426.26	3
Today Tonnes	69.16	
Tonnes To Date:	3,108.25	

By acceptance of this ticket (with or without signature), driver accepts on behalf of themselves/their employer sole responsibility to ensure that the load received is within the weight limit authorized by law and shall hold seller harmless against any and all claims with respect to same
CURB DELIVERY ONLY. NOT RESPONSIBLE FOR ANY DAMAGE BEYOND CURB.

Carrier: 8040648 GJ SCOTT LLC
Vehicle: GS14 GS14
License: As672T
MaxGVW: 80,000

Received: 
Weighmaster: Colleen LeSage
Cust: _____
P/D Status: Deliver

Customer Do Not Accept [1] Scale: 1



Plant: 32411

Berlin

368 New Brooklyn Road
Berlin, NJ 08009
856-809-0142,

3/10/2017 07:53 In: 7:28:15
Customer: 8638404 THE AMBIENT GROUP LLC
Order : 950949 Camden, NJ. ABC Barrel Project
P.O. :

Tkt. No. 1006027359



Product 114203
Bank Run
S.O. Info: Camden, NJ.
Ship Ref: 327 N. Front St

	Pounds	Kilo
Gross	77,960	35,362
Tare	27,360	12,410
Net	50,600	22,952
	25.30 Ton	22.95

	UNIT	TOTALS
Material:		
Freight:		
Tax:		
Fee / Fuel:		
Other Chrg:	No	

Today Tons:	101.54	Loads:
Tons To Date:	3,451.56	4
Today Tonnes	92.12	
Tonnes To Date:	3,131.20	

Carrier : 8040648 GJ SCOTT LLC
Vehicle: GS9 GS9
License: AK587X
MaxGVW: 80,000

By acceptance of this ticket (with or without signature), driver accepts on behalf of themselves/their employer sole responsibility to ensure that the load received is within the weight limit authorized by law and shall hold seller harmless against any and all claims with respect to same CURB DELIVERY ONLY. NOT RESPONSIBLE FOR ANY DAMAGE BEYOND CURB.

Received: _____
Weighmaster: Colleen LeSage

Cust: _____

P/D Status: Deliver

Customer Copy

Scale: 1



Plant: 32411

Berlin

368 New Brooklyn Road
Berlin, NJ 08009
856-809-0142,

3/10/2017 07:54 In: 7:35:09
Customer: 8638404 THE AMBIENT GROUP LLC
Order : 950949 Camden, NJ. ABC Barrel Project
P.O. :

Tkt. No. 1006027360



Product 114203
Bank Run
S.O. Info: Camden, NJ.
Ship Ref: 327 N. Front St

	Pounds	Kilo
Gross	75,480	34,237
Tare	25,540	11,585
Net	49,940	22,652
	24.97 Ton	22.65

	UNIT	TOTALS
Material:		
Freight:		
Tax:		
Fee / Fuel:		
Other Chrg:	No	

Today Tons:	126.51	Loads:
Tons To Date:	3,476.53	5
Today Tonnes	114.77	
Tonnes To Date:	3,153.85	

Carrier : 2347198 RAI0 CONTRACTING & MATE
Vehicle: RO223 Raio
License: AM608Y
MaxGVW: 80,000

By acceptance of this ticket (with or without signature), driver accepts on behalf of themselves/their employer sole responsibility to ensure that the load received is within the weight limit authorized by law and shall hold seller harmless against any and all claims with respect to same CURB DELIVERY ONLY. NOT RESPONSIBLE FOR ANY DAMAGE BEYOND CURB.

Received: _____
Weighmaster: Colleen LeSage

Cust: _____

P/D Status: Deliver

Customer Do Not Accept [2]

Scale: 1



Plant: 32411

Berlin
368 New Brooklyn Road
Berlin, NJ 08009
856-809-0142,

3/10/2017 07:57 In: 7:35:42
Customer: 8638404 THE AMBIENT GROUP LLC
Order : 950949 Camden, NJ. ABC Barrel Project
P.O. :

Tkt. No. 1006027361

Product 114203
Bank Run
S.O. Info: Camden, NJ.
Ship Ref: 327 N. Front St



	Pounds	Kilo
Gross	78,580	35,643
Tare	28,080	12,737
Net	50,500	22,906
	25.25 Ton	22.91

UNIT	TOTALS
Material:	
Freight:	
Tax:	
Fee / Fuel:	
Other Chrg: No	

Today Tons:	151.76	Loads:
Tons To Date:	3,501.78	6
Today Tonnes	137.67	
Tonnes To Date:	3,176.76	

By acceptance of this ticket (with or without signature), driver accepts on behalf of themselves/their employer sole responsibility to ensure that the load received is within the weight limit authorized by law and shall hold seller harmless against any and all claims with respect to same CURB DELIVERY ONLY. NOT RESPONSIBLE FOR ANY DAMAGE BEYOND CURB.

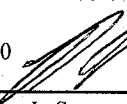
Carrier: 8040648 GJ SCOTT LLC
Vehicle: GS16 GS16
License: AT639K
MaxGVW: 80,000
Received: 
Weighmaster: Colleen LeSage

Cust: _____

P/D Status: Deliver

Customer Do Not Accept [2] Scale: 1



Plant: 32411

Berlin
368 New Brooklyn Road
Berlin, NJ 08009
856-809-0142,

3/10/2017 08:42 In: 8:27:31
Customer: 8638404 THE AMBIENT GROUP LLC
Order : 950949 Camden, NJ. ABC Barrel Project
P.O. :

Tkt. No. 1006027370

Product 114203
Bank Run
S.O. Info: Camden, NJ.
Ship Ref: 327 N. Front St



	Pounds	Kilo
Gross	74,860	33,956
Tare	24,860	11,276
Net	50,000	22,680
	25.00 Ton	22.68

UNIT	TOTALS
Material:	
Freight:	
Tax:	
Fee / Fuel:	
Other Chrg: No	

Today Tons:	176.76	Loads:
Tons To Date:	3,526.78	7
Today Tonnes	160.35	
Tonnes To Date:	3,199.44	

By acceptance of this ticket (with or without signature), driver accepts on behalf of themselves/their employer sole responsibility to ensure that the load received is within the weight limit authorized by law and shall hold seller harmless against any and all claims with respect to same CURB DELIVERY ONLY. NOT RESPONSIBLE FOR ANY DAMAGE BEYOND CURB.

Carrier: 2347198 RAO CONTRACTING & MATE
Vehicle: RO225 RAO
License: AP322C
MaxGVW: 80,000
Received: _____
Weighmaster: Colleen LeSage

Cust: _____

P/D Status: Deliver

Customer Do Not Accept [2] Scale: 1



Plant: 32411

Berlin

368 New Brooklyn Road
Berlin, NJ 08009
856-809-0142,

3/10/2017 08:47

In: 8:28:07

Customer: 8638404 THE AMBIENT GROUP LLC

Order: 950949 Camden, NJ. ABC Barrel Project

P.O.:

Tkt. No. 1006027371

Product 114203

Bank Run

S.O. Info: Camden, NJ.

Ship Ref: 327 N. Front St



	Pounds	Kilo
Gross	74,420	33,756
Tare	24,800	11,249
Net	49,620	22,507

24.81 Ton 22.51

	UNIT	TOTALS
Material:		
Freight:		
Tax:		
Fee / Fuel:		
Other Chrg: No		

Today Tons:	201.57	Loads:	
Tons To Date:	3,551.59		8
Today Tonnes	182.86		
Tonnes To Date:	3,221.95		

Carrier: 2347198 RAIO CONTRACTING & MATE

Vehicle: RO219 AJ734F

License: RO219

MaxGVW: 80,000

Received: MRE

Weighmaster: Colleen LeSage

Cust: _____

P/D Status: Deliver

Customer Copy

Scale: 1

By acceptance of this ticket (with or without signature), driver accepts on behalf of themselves/their employer sole responsibility to ensure that the load received is within the weight limit authorized by law and shall hold seller harmless against any and all claims with respect to same CURB DELIVERY ONLY. NOT RESPONSIBLE FOR ANY DAMAGE BEYOND CURB.



Plant: 32411

Berlin

368 New Brooklyn Road
Berlin, NJ 08009
856-809-0142,

3/10/2017 08:59

In:

Customer: 8638404 THE AMBIENT GROUP LLC

Order: 950949 Camden, NJ. ABC Barrel Project

P.O.:

Tkt. No. 1006027372

Product 114203

Bank Run

S.O. Info: Camden, NJ.

Ship Ref: 327 N. Front St



	Pounds	Kilo
Gross	77,780	35,280
Tare	27,680 *	12,555
Net	50,100	22,725

25.05 Ton 22.72

* Predetermined Tare

	UNIT	TOTALS
Material:		
Freight:		
Tax:		
Fee / Fuel:		
Other Chrg: No		

Today Tons:	226.62	Loads:	
Tons To Date:	3,576.64		9
Today Tonnes	205.59		
Tonnes To Date:	3,244.67		

Carrier: 8040648 GJ SCOTT LLC

Vehicle: GS4 GS4

License: AJ118L

MaxGVW: 80,000

Received: [Signature]

Weighmaster: Colleen LeSage

Cust: _____

P/D Status: Deliver

Customer Do Not Accept [2]

Scale: 1

By acceptance of this ticket (with or without signature), driver accepts on behalf of themselves/their employer sole responsibility to ensure that the load received is within the weight limit authorized by law and shall hold seller harmless against any and all claims with respect to same CURB DELIVERY ONLY. NOT RESPONSIBLE FOR ANY DAMAGE BEYOND CURB.

Hanson

Plant: 32411

Berlin368 New Brooklyn Road
Berlin, NJ 08009
856-809-0142,

3/10/2017 09:05

In :

Customer: 8638404 THE AMBIENT GROUP LLC

Order : 950949 Camden, NJ. ABC Barrel Project

P.O. :

Tkt. No. 1006027373

Product 114203

Bank Run

S.O. Info: Camden, NJ.

Ship Ref: 327 N. Front St



	UNIT	TOTALS
Material:		
Freight:		
Tax:		
Fee / Fuel:		
Other Chrg: No		

	Pounds	Kilo
Gross	78,360	35,543
Tare	27,860 *	12,637
Net	50,500	22,906

25.25 Ton 22.91

* Predetermined Tare

Today Tons:	251.87	Loads:
Tons To Date:	3,601.89	10
Today Tonnes	228.49	
Tonnes To Date:	3,267.58	

By acceptance of this ticket (with or without signature), driver accepts on behalf of themselves/their employer sole responsibility to ensure that the load received is within the weight limit authorized by law and shall hold seller harmless against any and all claims with respect to same
CURB DELIVERY ONLY. NOT RESPONSIBLE FOR ANY DAMAGE BEYOND CURB.

Carrier : 9249110 CLM CONTRACTING LLC

Vehicle: CLM6 CLM6

License: AT597T

MaxGVW: 80,000

Received: _____

Weighmaster: Colleen LeSage

Cust: _____

P/D Status: Deliver

Customer Do Not Accept [2] Scale: 1

Hanson

Plant: 32411

Berlin368 New Brooklyn Road
Berlin, NJ 08009
856-809-0142,

3/10/2017 09:38

In :

Customer: 8638404 THE AMBIENT GROUP LLC

Order : 950949 Camden, NJ. ABC Barrel Project

P.O. :

Tkt. No. 1006027374

Product 114203

Bank Run

S.O. Info: Camden, NJ.

Ship Ref: 327 N. Front St



	UNIT	TOTALS
Material:		
Freight:		
Tax:		
Fee / Fuel:		
Other Chrg: No		

	Pounds	Kilo
Gross	77,720	35,253
Tare	28,080 *	12,737
Net	49,640	22,516

24.82 Ton 22.52

* Predetermined Tare

Today Tons:	276.69	Loads:
Tons To Date:	3,626.71	11
Today Tonnes	251.01	
Tonnes To Date:	3,290.10	

By acceptance of this ticket (with or without signature), driver accepts on behalf of themselves/their employer sole responsibility to ensure that the load received is within the weight limit authorized by law and shall hold seller harmless against any and all claims with respect to same
CURB DELIVERY ONLY. NOT RESPONSIBLE FOR ANY DAMAGE BEYOND CURB.

Carrier : 8040648 GJ SCOTT LLC

Vehicle: GS16 GS16

License: AT639K

MaxGVW: 80,000

Received: _____

Weighmaster: Colleen LeSage

Cust: _____

P/D Status: Deliver

Customer Copy Scale: 1



Plant: 32411

Berlin

368 New Brooklyn Road
Berlin, NJ 08009
856-809-0142,

3/10/2017 09:41

In:

Customer: 8638404 THE AMBIENT GROUP LLC

Order : 950949 Camden, NJ. ABC Barrel Project

P.O. :

Tkt. No. 1006027375

Product 114203

Bank Run

S.O. Info: Camden, NJ.

Ship Ref: 327 N. Front St



	Pounds	Kilo
Gross	75,560	34,273
Tare	25,540 *	11,585
Net	50,020	22,689

25.01 Ton 22.69

* Predetermined Tare

Today Tons:	301.70	Loads:
Tons To Date:	3,651.72	12
Today Tonnes	273.70	
Tonnes To Date:	3,312.78	

By acceptance of this ticket (with or without signature), driver accepts on behalf of themselves/their employer sole responsibility to ensure that the load received is within the weight limit authorized by law and shall hold seller harmless against any and all claims with respect to same CURB DELIVERY ONLY. NOT RESPONSIBLE FOR ANY DAMAGE BEYOND CURB.

	UNIT	TOTALS
Material:		
Freight:		
Tax:		
Fee / Fuel:		
Other Chrg: No		

Carrier : 2347198 RAIO CONTRACTING & MATE

Vehicle: RO223 Raio

License: AM608Y

MaxGVW: 80,000

Received: _____

Cust: _____

Weighmaster: Colleen LeSage

P/D Status: Deliver

Customer Do Not Accept [3] Scale: 1



Plant: 32411

Berlin

368 New Brooklyn Road
Berlin, NJ 08009
856-809-0142,

3/10/2017 09:43

In:

Customer: 8638404 THE AMBIENT GROUP LLC

Order : 950949 Camden, NJ. ABC Barrel Project

P.O. :

Tkt. No. 1006027376

Product 114203

Bank Run

S.O. Info: Camden, NJ.

Ship Ref: 327 N. Front St



	Pounds	Kilo
Gross	77,320	35,072
Tare	28,640 *	12,991
Net	48,680	22,081

24.34 Ton 22.08

* Predetermined Tare

Today Tons:	326.04	Loads:
Tons To Date:	3,676.06	13
Today Tonnes	295.78	
Tonnes To Date:	3,334.87	

By acceptance of this ticket (with or without signature), driver accepts on behalf of themselves/their employer sole responsibility to ensure that the load received is within the weight limit authorized by law and shall hold seller harmless against any and all claims with respect to same CURB DELIVERY ONLY. NOT RESPONSIBLE FOR ANY DAMAGE BEYOND CURB.

	UNIT	TOTALS
Material:		
Freight:		
Tax:		
Fee / Fuel:		
Other Chrg: No		

Carrier : 8040648 GJ SCOTT LLC

Vehicle: GS14 GS14

License: As6721

MaxGVW: 80,000

Received: _____

Cust: _____

Weighmaster: Colleen LeSage

P/D Status: Deliver

Customer Copy Scale: 1



Plant: 32411

Berlin

368 New Brooklyn Road
Berlin, NJ 08009
856-809-0142,

3/10/2017 09:45

In :

Customer: 8638404 THE AMBIENT GROUP LLC

Order : 950949 Camden, NJ. ABC Barrel Project

P.O. :

Tkt. No. 1006027377

Product 114203

Bank Run

S.O. Info: Camden, NJ.

Ship Ref: 327 N. Front St



	Pounds	Kilo
Gross	77,260	35,045
Tare	27,360 *	12,410
Net	49,900	22,634

24.95 Ton 22.63

* Predetermined Tare

	UNIT	TOTALS
Material:		
Freight:		
Tax:		
Fee / Fuel:		
Other Chrg:	No	

Today Tons:	350.99	Loads:
Tons To Date:	3,701.01	14
Today Tonnes	318.41	
Tonnes To Date:	3,357.50	

Carrier : 8040648 GJ SCOTT LLC

Vehicle: GS9 GS9

License: AK587X

MaxGVW: 80,000

Received: _____

Cust: _____

Weighmaster: Colleen LeSage

P/D Status: Deliver

Customer Copy

Scale: 1

By acceptance of this ticket (with or without signature), driver accepts on behalf of themselves/their employer sole responsibility to ensure that the load received is within the weight limit authorized by law and shall hold seller harmless against any and all claims with respect to same CURB DELIVERY ONLY. NOT RESPONSIBLE FOR ANY DAMAGE BEYOND CURB.



Plant: 32411

Berlin

368 New Brooklyn Road
Berlin, NJ 08009
856-809-0142,

3/10/2017 10:19

In :

Customer: 8638404 THE AMBIENT GROUP LLC

Order : 950949 Camden, NJ. ABC Barrel Project

P.O. :

Tkt. No. 1006027378

Product 114203

Bank Run

S.O. Info: Camden, NJ.

Ship Ref: 327 N. Front St



	Pounds	Kilo
Gross	75,360	34,183
Tare	24,860 *	11,276
Net	50,500	22,906

25.25 Ton 22.91

* Predetermined Tare

	UNIT	TOTALS
Material:		
Freight:		
Tax:		
Fee / Fuel:		
Other Chrg:	No	

Today Tons:	376.24	Loads:
Tons To Date:	3,726.26	15
Today Tonnes	341.32	
Tonnes To Date:	3,380.41	

Carrier : 2347198 RAIO CONTRACTING & MATE

Vehicle: RO225 RAIO

License: AP322C

MaxGVW: 80,000

Received: _____

Cust: _____

Weighmaster: Colleen LeSage

P/D Status: Deliver

Customer Copy

Scale: 1

By acceptance of this ticket (with or without signature), driver accepts on behalf of themselves/their employer sole responsibility to ensure that the load received is within the weight limit authorized by law and shall hold seller harmless against any and all claims with respect to same CURB DELIVERY ONLY. NOT RESPONSIBLE FOR ANY DAMAGE BEYOND CURB.



Plant: 32411

Berlin

368 New Brooklyn Road
Berlin, NJ 08009
856-809-0142

3/10/2017 10:39

In :

Customer: 8638404 THE AMBIENT GROUP LLC

Order : 950949 Camden, NJ. ABC Barrel Project

P.O. :

Tkt. No. 1006027380

Product 114203

Bank Run

S.O. Info: Camden, NJ.

Ship Ref: 327 N. Front St



	Pounds	Kilo
Gross	77,680	35,235
Tare	27,680 *	12,555
Net	50,000	22,680

25.00 Ton 22.68

* Predetermined Tare

	UNIT	TOTALS
Material:		
Freight:		
Tax:		
Fee / Fuel:		
Other Chrg:	No	

Today Tons:	401.24	Loads:
Tons To Date:	3,751.26	16
Today Tonnes	364.00	
Tonnes To Date:	3,403.09	

Carrier : 8040648 GJ SCOTT LLC

Vehicle: GS4 GS4

License: AJ118L

MaxGVW: 80,000

Received:

Weighmaster: Colleen LeSage

Cust:

By acceptance of this ticket (with or without signature), driver accepts on behalf of themselves/their employer sole responsibility to ensure that the load received is within the weight limit authorized by law and shall hold seller harmless against any and all claims with respect to same CURB DELIVERY ONLY. NOT RESPONSIBLE FOR ANY DAMAGE BEYOND CURB.

P/D Status: Deliver

Customer Copy

Scale: 1



Plant: 32411

Berlin

368 New Brooklyn Road
Berlin, NJ 08009
856-809-0142

3/10/2017 10:41

In :

Customer: 8638404 THE AMBIENT GROUP LLC

Order : 950949 Camden, NJ. ABC Barrel Project

P.O. :

Tkt. No. 1006027381

Product 114203

Bank Run

S.O. Info: Camden, NJ.

Ship Ref: 327 N. Front St



	Pounds	Kilo
Gross	74,800	33,929
Tare	24,800 *	11,249
Net	50,000	22,680

25.00 Ton 22.68

* Predetermined Tare

	UNIT	TOTALS
Material:		
Freight:		
Tax:		
Fee / Fuel:		
Other Chrg:	No	

Today Tons:	426.24	Loads:
Tons To Date:	3,776.26	17
Today Tonnes	386.68	
Tonnes To Date:	3,425.77	

Carrier : 2347198 RAIO CONTRACTING & MATE

Vehicle: RO219 AJ734F

License: RO219

MaxGVW: 80,000

Received:

Weighmaster: Colleen LeSage

Cust:

By acceptance of this ticket (with or without signature), driver accepts on behalf of themselves/their employer sole responsibility to ensure that the load received is within the weight limit authorized by law and shall hold seller harmless against any and all claims with respect to same CURB DELIVERY ONLY. NOT RESPONSIBLE FOR ANY DAMAGE BEYOND CURB.

P/D Status: Deliver

Customer Do Not Accept [1]

Scale: 1



Plant: 32411

Berlin
368 New Brooklyn Road
Berlin, NJ 08009
856-809-0142.

3/10/2017 10:43 In:
Customer: 8638404 THE AMBIENT GROUP LLC
Order : 950949 Camden, NJ. ABC Barrel Project
P.O. :

Tkt. No. 1006027382



Product 114203
Bank Run
S.O. Info: Camden, NJ.
Ship Ref: 327 N. Front St

	Pounds	Kilo
Gross	78,560	35,634
Tare	27,860 *	12,637
Net	50,700	22,997

25.35 Ton 23.00

* Predetermined Tare

	UNIT	TOTALS
Material:		
Freight:		
Tax:		
Fee / Fuel:		
Other Chrg: No		

Today Tons:	451.59	Loads:
Tons To Date:	3,801.61	18
Today Tonnes	409.68	
Tonnes To Date:	3,448.76	

Carrier : 9249110 CLM CONTRACTING LLC
Vehicle: CLM6 CLM6
License: AT597T
MaxGVW: 80,000
Received: _____
Weighmaster: Colleen LeSage

By acceptance of this ticket (with or without signature), driver accepts on behalf of themselves/their employer sole responsibility to ensure that the load received is within the weight limit authorized by law and shall hold seller harmless against any and all claims with respect to same CURB DELIVERY ONLY. NOT RESPONSIBLE FOR ANY DAMAGE BEYOND CURB.

Cust: _____

P/D Status: Deliver

Customer Do Not Accept [2] Scale: 1



Plant: 32411

Berlin
368 New Brooklyn Road
Berlin, NJ 08009
856-809-0142.

3/10/2017 11:10 In:
Customer: 8638404 THE AMBIENT GROUP LLC
Order : 950949 Camden, NJ. ABC Barrel Project
P.O. :

Tkt. No. 1006027383



Product 114203
Bank Run
S.O. Info: Camden, NJ.
Ship Ref: 327 N. Front St

	Pounds	Kilo
Gross	78,900	35,788
Tare	28,080 *	12,737
Net	50,820	23,052

25.41 Ton 23.05

* Predetermined Tare

	UNIT	TOTALS
Material:		
Freight:		
Tax:		
Fee / Fuel:		
Other Chrg: No		

Today Tons:	477.00	Loads:
Tons To Date:	3,827.02	19
Today Tonnes	432.73	
Tonnes To Date:	3,471.81	

Carrier : 8040648 GJ SCOTT LLC
Vehicle: GS16 GS16
License: AT639K
MaxGVW: 80,000
Received: _____
Weighmaster: Colleen LeSage

By acceptance of this ticket (with or without signature), driver accepts on behalf of themselves/their employer sole responsibility to ensure that the load received is within the weight limit authorized by law and shall hold seller harmless against any and all claims with respect to same CURB DELIVERY ONLY. NOT RESPONSIBLE FOR ANY DAMAGE BEYOND CURB.

Cust: _____

P/D Status: Deliver

Customer Copy Scale: 1



Plant: 32411

Berlin

368 New Brooklyn Road
Berlin, NJ 08009
856-809-0142

3/10/2017 11:12 In :
Customer: 8638404 THE AMBIENT GROUP LLC
Order : 950949 Camden, NJ. ABC Barrel Project
P.O. :

Tkt. No. 1006027384



Product 114203
Bank Run
S.O. Info: Camden, NJ.
Ship Ref: 327 N. Front St

	Pounds	Kilo
Gross	79,000	35,834
Tare	28,640 *	12,991
Net	50,360	22,843

25.18 Ton 22.84

* Predetermined Tare

	UNIT	TOTALS
Material:		
Freight:		
Tax:		
Fee / Fuel:		
Other Chrg:	No	

Today Tons:	502.18	Loads:
Tons To Date:	3,852.20	20
Today Tonnes	455.57	
Tonnes To Date:	3,494.66	

Carrier : 8040648 GJ SCOTT LLC

Vehicle: GS14 GS14

License: **As672T**

MaxGVW: 80,000

Received: _____

Weighmaster: Colleen LeSage

Cust: _____

P/D Status: **Deliver**

Customer Copy

Scale: 1

By acceptance of this ticket (with or without signature), driver accepts on behalf of themselves/their employer sole responsibility to ensure that the load received is within the weight limit authorized by law and shall hold seller harmless against any and all claims with respect to same CURB DELIVERY ONLY. NOT RESPONSIBLE FOR ANY DAMAGE BEYOND CURB.



Plant: 32411

Berlin

368 New Brooklyn Road
Berlin, NJ 08009
856-809-0142

3/10/2017 11:15 In :
Customer: 8638404 THE AMBIENT GROUP LLC
Order : 950949 Camden, NJ. ABC Barrel Project
P.O. :

Tkt. No. 1006027385



Product 114203
Bank Run
S.O. Info: Camden, NJ.
Ship Ref: 327 N. Front St

	Pounds	Kilo
Gross	77,100	34,972
Tare	27,360 *	12,410
Net	49,740	22,562

24.87 Ton 22.56

* Predetermined Tare

	UNIT	TOTALS
Material:		
Freight:		
Tax:		
Fee / Fuel:		
Other Chrg:	No	

Today Tons:	527.05	Loads:
Tons To Date:	3,877.07	21
Today Tonnes	478.13	
Tonnes To Date:	3,517.22	

Carrier : 8040648 GJ SCOTT LLC

Vehicle: GS9 GS9

License: **AK587X**

MaxGVW: 80,000

Received: _____

Weighmaster: Colleen LeSage

Cust: _____

P/D Status: **Deliver**

Customer Do Not Accept [3]

Scale: 1

By acceptance of this ticket (with or without signature), driver accepts on behalf of themselves/their employer sole responsibility to ensure that the load received is within the weight limit authorized by law and shall hold seller harmless against any and all claims with respect to same CURB DELIVERY ONLY. NOT RESPONSIBLE FOR ANY DAMAGE BEYOND CURB.



Plant: 32411

Berlin

368 New Brooklyn Road
Berlin, NJ 08009
856-809-0142

3/10/2017 11:21

In :

Customer: 8638404 THE AMBIENT GROUP LLC

Order : 950949 Camden, NJ. ABC Barrel Project

P.O. :

Tkt. No. 1006027386

Product 114203

Bank Run

S.O. Info: Camden, NJ.

Ship Ref: 327 N. Front St



	UNIT	TOTALS
Material:		
Freight:		
Tax:		
Fee / Fuel:		
Other Chrg: No		

	Pounds	Kilo
Gross	75,080	34,056
Tare	25,540 *	11,585
Net	49,540	22,471

24.77 Ton 22.47

* Predetermined Tare

Today Tons:	551.82	Loads:
Tons To Date:	3,901.84	22
Today Tonnes	500.60	
Tonnes To Date:	3,539.69	

Carrier : 2347198 RAIO CONTRACTING & MATE

Vehicle: RO223 Raio

License: AM608Y

MaxGVW: 80,000

Received: _____

Cust: _____

Weighmaster: Colleen LeSage

P/D Status: Deliver

Customer Do Not Accept [1] Scale: 1

By acceptance of this ticket (with or without signature), driver accepts on behalf of themselves/their employer sole responsibility to ensure that the load received is within the weight limit authorized by law and shall hold seller harmless against any and all claims with respect to same CURB DELIVERY ONLY. NOT RESPONSIBLE FOR ANY DAMAGE BEYOND CURB.



Plant: 32411

Berlin

368 New Brooklyn Road
Berlin, NJ 08009
856-809-0142

3/10/2017 11:45

In :

Customer: 8638404 THE AMBIENT GROUP LLC

Order : 950949 Camden, NJ. ABC Barrel Project

P.O. :

Tkt. No. 1006027387

Product 114203

Bank Run

S.O. Info: Camden, NJ.

Ship Ref: 327 N. Front St



	UNIT	TOTALS
Material:		
Freight:		
Tax:		
Fee / Fuel:		
Other Chrg: No		

	Pounds	Kilo
Gross	75,860	34,410
Tare	24,860 *	11,276
Net	51,000	23,133

25.50 Ton 23.13

* Predetermined Tare

Today Tons:	577.32	Loads:
Tons To Date:	3,927.34	23
Today Tonnes	523.74	
Tonnes To Date:	3,562.82	

Carrier : 2347198 RAIO CONTRACTING & MATE

Vehicle: RO225 RAIO

License: AP322C

MaxGVW: 80,000

Received: _____

Cust: _____

Weighmaster: Colleen LeSage

P/D Status: Deliver

Customer Copy Scale: 1

By acceptance of this ticket (with or without signature), driver accepts on behalf of themselves/their employer sole responsibility to ensure that the load received is within the weight limit authorized by law and shall hold seller harmless against any and all claims with respect to same CURB DELIVERY ONLY. NOT RESPONSIBLE FOR ANY DAMAGE BEYOND CURB.



Plant: 32411

Berlin

368 New Brooklyn Road
Berlin, NJ 08009
856-809-0142

3/10/2017 11:59

In :

Customer: 8638404 THE AMBIENT GROUP LLC

Order : 950949 Camden, NJ. ABC Barrel Project

P.O. :

Tkt. No. 1006027388

Product 114203



Bank Run

S.O. Info: Camden, NJ.

Ship Ref: 327 N. Front St

	Pounds	Kilo
Gross	77,960	35,362
Tare	27,680 *	12,555
Net	50,280	22,807

25.14 Ton 22.81

* Predetermined Tare

	UNIT	TOTALS
Material:		
Freight:		
Tax:		
Fee / Fuel:		
Other Chrg: No		

Today Tons:	602.46	Loads:
Tons To Date:	3,952.48	24
Today Tonnes	546.54	
Tonnes To Date:	3,585.63	

By acceptance of this ticket (with or without signature), driver accepts on behalf of themselves/their employer sole responsibility to ensure that the load received is within the weight limit authorized by law and shall hold seller harmless against any and all claims with respect to same CURB DELIVERY ONLY. NOT RESPONSIBLE FOR ANY DAMAGE BEYOND CURB.

Carrier : 8040648 GJ SCOTT LLC

Vehicle: GS4 GS4

License: AJ118L

MaxGVW: 80,000

Received: _____

Cust: _____

Weighmaster: Colleen LeSage

P/D Status: Deliver

Customer Do Not Accept [1] Scale: 1



Plant: 32411

Berlin

368 New Brooklyn Road
Berlin, NJ 08009
856-809-0142

3/10/2017 12:14

In :

Customer: 8638404 THE AMBIENT GROUP LLC

Order : 950949 Camden, NJ. ABC Barrel Project

P.O. :

Tkt. No. 1006027389

Product 114203



Bank Run

S.O. Info: Camden, NJ.

Ship Ref: 327 N. Front St

	Pounds	Kilo
Gross	74,360	33,729
Tare	24,800 *	11,249
Net	49,560	22,480

24.78 Ton 22.48

* Predetermined Tare

	UNIT	TOTALS
Material:		
Freight:		
Tax:		
Fee / Fuel:		
Other Chrg: No		

Today Tons:	627.24	Loads:
Tons To Date:	3,977.26	25
Today Tonnes	569.02	
Tonnes To Date:	3,608.11	

By acceptance of this ticket (with or without signature), driver accepts on behalf of themselves/their employer sole responsibility to ensure that the load received is within the weight limit authorized by law and shall hold seller harmless against any and all claims with respect to same CURB DELIVERY ONLY. NOT RESPONSIBLE FOR ANY DAMAGE BEYOND CURB.

Carrier : 2347198 RAIO CONTRACTING & MATE

Vehicle: RO219 AJ734F

License: RO219

MaxGVW: 80,000

Received: _____

Cust: _____

Weighmaster: Colleen LeSage

P/D Status: Deliver

Customer Do Not Accept [1] Scale: 1



Plant: 32411

Berlin

368 New Brooklyn Road
Berlin, NJ 08009
856-809-0142,

3/10/2017 12:18

In :

Customer: 8638404 THE AMBIENT GROUP LLC

Order : 950949 Camden, NJ. ABC Barrel Project

P.O. :

Tkt. No. 1006027390

Product 114203

Bank Run

S.O. Info: Camden, NJ.

Ship Ref: 327 N. Front St



	Pounds	Kilo
Gross	78,800	35,743
Tare	27,860 *	12,637
Net	50,940	23,106

25.47 Ton 23.11

* Predetermined Tare

	UNIT	TOTALS
Material:		
Freight:		
Tax:		
Fee / Fuel:		
Other Chrg:	No	

Today Tons:	652.71	Loads:
Tons To Date:	4,002.73	26
Today Tonnes	592.13	
Tonnes To Date:	3,631.22	

Carrier : 9249110 CLM CONTRACTING LLC

Vehicle: CLM6 CLM6

License: AT597T

MaxGVW: 80,000

Received: _____

Weighmaster: Colleen LeSage

Cust: _____

P/D Status: Deliver

Customer Copy

Scale: 1

By acceptance of this ticket (with or without signature), driver accepts on behalf of themselves/their employer sole responsibility to ensure that the load received is within the weight limit authorized by law and shall hold seller harmless against any and all claims with respect to same CURB DELIVERY ONLY. NOT RESPONSIBLE FOR ANY DAMAGE BEYOND CURB.



Plant: 32411

Berlin

368 New Brooklyn Road
Berlin, NJ 08009
856-809-0142,

3/10/2017 12:34

In :

Customer: 8638404 THE AMBIENT GROUP LLC

Order : 950949 Camden, NJ. ABC Barrel Project

P.O. :

Tkt. No. 1006027391

Product 114203

Bank Run

S.O. Info: Camden, NJ.

Ship Ref: 327 N. Front St



	Pounds	Kilo
Gross	78,560	35,634
Tare	28,080 *	12,737
Net	50,480	22,897

25.24 Ton 22.90

* Predetermined Tare

	UNIT	TOTALS
Material:		
Freight:		
Tax:		
Fee / Fuel:		
Other Chrg:	No	

Today Tons:	677.95	Loads:
Tons To Date:	4,027.97	27
Today Tonnes	615.03	
Tonnes To Date:	3,654.11	

Carrier : 8040648 GJ SCOTT LLC

Vehicle: GS16 GS16

License: AT639K

MaxGVW: 80,000

Received: _____

Weighmaster: Colleen LeSage

Cust: _____

P/D Status: Deliver

Customer Copy

Scale: 1

By acceptance of this ticket (with or without signature), driver accepts on behalf of themselves/their employer sole responsibility to ensure that the load received is within the weight limit authorized by law and shall hold seller harmless against any and all claims with respect to same CURB DELIVERY ONLY. NOT RESPONSIBLE FOR ANY DAMAGE BEYOND CURB.



Plant: 32411

Berlin

368 New Brooklyn Road
Berlin, NJ 08009
856-809-0142

3/10/2017 12:40

In :

Customer: 8638404 THE AMBIENT GROUP LLC

Order : 950949 Camden, NJ. ABC Barrel Project

P.O. :

Tkt. No. 1006027392

Product 114203

Bank Run

S.O. Info: Camden, NJ.

Ship Ref: 327 N. Front St



	Pounds	Kilo
Gross	77,300	35,063
Tare	27,360 *	12,410
Net	49,940	22,652

24.97 Ton 22.65

* Predetermined Tare

	UNIT	TOTALS
Material:		
Freight:		
Tax:		
Fee / Fuel:		
Other Chrg: No		

Today Tons:	702.92	Loads:
Tons To Date:	4,052.94	28
Today Tonnes	637.68	
Tonnes To Date:	3,676.77	

Carrier : 8040648 GJ SCOTT LLC

Vehicle: GS9 GS9

License: AK587X

MaxGVW: 80,000

Received: _____

Weighmaster: Colleen LeSage

P/D Status: Deliver

By acceptance of this ticket (with or without signature), driver accepts on behalf of themselves/their employer sole responsibility to ensure that the load received is within the weight limit authorized by law and shall hold seller harmless against any and all claims with respect to same CURB DELIVERY ONLY. NOT RESPONSIBLE FOR ANY DAMAGE BEYOND CURB.

Cust: _____

Customer Copy

Scale: 1



Plant: 32411

Berlin

368 New Brooklyn Road
Berlin, NJ 08009
856-809-0142

3/10/2017 12:42

In :

Customer: 8638404 THE AMBIENT GROUP LLC

Order : 950949 Camden, NJ. ABC Barrel Project

P.O. :

Tkt. No. 1006027393

Product 114203

Bank Run

S.O. Info: Camden, NJ.

Ship Ref: 327 N. Front St



	Pounds	Kilo
Gross	78,900	35,788
Tare	28,640 *	12,991
Net	50,260	22,798

25.13 Ton 22.80

* Predetermined Tare

	UNIT	TOTALS
Material:		
Freight:		
Tax:		
Fee / Fuel:		
Other Chrg: No		

Today Tons:	728.05	Loads:
Tons To Date:	4,078.07	29
Today Tonnes	660.48	
Tonnes To Date:	3,699.56	

Carrier : 8040648 GJ SCOTT LLC

Vehicle: GS14 GS14

License: As672T

MaxGVW: 80,000

Received: _____

Weighmaster: Colleen LeSage

P/D Status: Deliver

By acceptance of this ticket (with or without signature), driver accepts on behalf of themselves/their employer sole responsibility to ensure that the load received is within the weight limit authorized by law and shall hold seller harmless against any and all claims with respect to same CURB DELIVERY ONLY. NOT RESPONSIBLE FOR ANY DAMAGE BEYOND CURB.

Cust: _____

Customer Do Not Accept [2]

Scale: 1



Plant: 32411

Berlin
368 New Brooklyn Road
Berlin, NJ 08009
856-809-0142

3/10/2017 13:08 In :
Customer: 8638404 THE AMBIENT GROUP LLC
Order : 950949 Camden, NJ. ABC Barrel Project
P.O. :

Tkt. No. 1006027394

Product 114203
Bank Run
S.O. Info: Camden, NJ.
Ship Ref: 327 N. Front St.



	Pounds	Kilo
Gross	75,680	34,328
Tare	25,540 *	11,585
Net	50,140	22,743

25.07 Ton 22.74

* Predetermined Tare

	UNIT	TOTALS
Material:		
Freight:		
Tax:		
Fee / Fuel:		
Other Chrg: No		

Today Tons:	753.12	Loads:
Tons To Date:	4,103.14	30
Today Tonnes	683.22	
Tonnes To Date:	3,722.31	

Carrier : 2347198 RAIO CONTRACTING & MATE
Vehicle: RO223 Raio
License: AM608Y
MaxGVW: 80,000

By acceptance of this ticket (with or without signature), driver accepts on behalf of themselves/their employer sole responsibility to ensure that the load received is within the weight limit authorized by law and shall hold seller harmless against any and all claims with respect to same CURB DELIVERY ONLY. NOT RESPONSIBLE FOR ANY DAMAGE BEYOND CURB.

Received: _____ Cust: _____

Weighmaster: Colleen LeSage

P/D Status: Deliver

Customer Do Not Accept [2] Scale: 1



Plant: 32411

Berlin
368 New Brooklyn Road
Berlin, NJ 08009
856-809-0142

3/10/2017 13:24 In :
Customer: 8638404 THE AMBIENT GROUP LLC
Order : 950949 Camden, NJ. ABC Barrel Project
P.O. :

Tkt. No. 1006027395

Product 114203
Bank Run
S.O. Info: Camden, NJ.
Ship Ref: 327 N. Front St.



	Pounds	Kilo
Gross	77,500	35,153
Tare	27,680 *	12,555
Net	49,820	22,598

24.91 Ton 22.60

* Predetermined Tare

	UNIT	TOTALS
Material:		
Freight:		
Tax:		
Fee / Fuel:		
Other Chrg: No		

Today Tons:	778.03	Loads:
Tons To Date:	4,128.05	31
Today Tonnes	705.82	
Tonnes To Date:	3,744.90	

Carrier : 8040648 GJ SCOTT LLC
Vehicle: GS4 GS4
License: AJ118L
MaxGVW: 80,000

By acceptance of this ticket (with or without signature), driver accepts on behalf of themselves/their employer sole responsibility to ensure that the load received is within the weight limit authorized by law and shall hold seller harmless against any and all claims with respect to same CURB DELIVERY ONLY. NOT RESPONSIBLE FOR ANY DAMAGE BEYOND CURB.

Received: _____ Cust: _____

Weighmaster: Colleen LeSage

P/D Status: Deliver

Customer Do Not Accept [1] Scale: 1

Hanson

Plant: 32411

Berlin

368 New Brooklyn Road

Berlin, NJ 08009

856-809-0142

3/10/2017 13:43

In:

Customer: 8638404 THE AMBIENT GROUP LLC

Order : 950949 Camden, NJ. ABC Barrel Project

P.O. :

Tkt. No. 1006027396

Product 114203

Bank Run

S.O. Info: Camden, NJ.

Ship Ref: 327 N. Front St



	<u>Pounds</u>	<u>Kilo</u>
Gross	77,820	35,299
Tare	27,860 *	12,637
Net	49,960	22,661

24.98 Ton 22.66

* Predetermined Tare

	<u>UNIT</u>	<u>TOTALS</u>
Material:		
Freight:		
Tax:		
Fee / Fuel:		
Other Chrg: No		

Today Tons:	803.01	Loads:
Tons To Date:	4,153.03	32
Today Tonnes	728.48	
Tonnes To Date:	3,767.57	

Carrier : 9249110 CLM CONTRACTING LLC

Vehicle: CLM6 CLM6

License: AT597T

MaxGVW: 80,000

Received: _____

Weighmaster: Colleen LeSage

P/D Status: Deliver

Cust: _____

Customer: Do Not Accept [2] Scale: 1

By acceptance of this ticket (with or without signature), driver accepts on behalf of themselves/their employer sole responsibility to ensure that the load received is within the weight limit authorized by law and shall hold harmless against any and all claims with respect to said load.
CURB DELIVERY ONLY. NOT RESPONSIBLE FOR ANY DAMAGE BEYOND CURB.



Plant: 32411

Berlin

368 New Brooklyn Road
Berlin, NJ 08009
856-809-0142

3/13/2017 07:11

In: 6:39:32

Customer: 8638404 THE AMBIENT GROUP LLC

Order: 950949 Camden, NJ. ABC Barrel Project

P.O.:

Tkt. No. 1006027397

Product 114203



Bank Run

S.O. Info: Camden, NJ.

Ship Ref: 327 N. Front St

	Pounds	Kilo
Gross	75,860	34,410
Tare	28,020	12,710
Net	47,840	21,700

23.92 Ton 21.70

	UNIT	TOTALS
Material:		
Freight:		
Tax:		
Fee / Fuel:		
Other Chrg: No		

Today Tons:	23.92	Loads:
Tons To Date:	4,176.95	1
Today Tonnes	21.70	
Tonnes To Date:	3,789.27	

Carrier: 9249110 CLM CONTRACTING LLC

Vehicle: CLM6 CLM6

License: AT597T

MaxGVW: 80,000

Received:

Weighmaster: Colleen LeSage

P/D Status: Deliver

Cust:

Customer Do Not Accept [1] Scale: 1

By acceptance of this ticket (with or without signature), driver accepts on behalf of themselves/their employer sole responsibility to ensure that the load received is within the weight limit authorized by law and shall hold seller harmless against any and all claims with respect to same CURB DELIVERY ONLY. NOT RESPONSIBLE FOR ANY DAMAGE BEYOND CURB.



Plant: 32411

Berlin

368 New Brooklyn Road
Berlin, NJ 08009
856-809-0142

3/13/2017 07:15

In: 6:48:25

Customer: 8638404 THE AMBIENT GROUP LLC

Order: 950949 Camden, NJ. ABC Barrel Project

P.O.:

Tkt. No. 1006027398

Product 114203



Bank Run

S.O. Info: Camden, NJ.

Ship Ref: 327 N. Front St

	Pounds	Kilo
Gross	75,900	34,428
Tare	27,380	12,419
Net	48,520	22,008

24.26 Ton 22.01

	UNIT	TOTALS
Material:		
Freight:		
Tax:		
Fee / Fuel:		
Other Chrg: No		

Today Tons:	48.18	Loads:
Tons To Date:	4,201.21	2
Today Tonnes	43.71	
Tonnes To Date:	3,811.27	

Carrier: 8040648 GJ SCOTT LLC

Vehicle: GS4 GS4

License: AJ118L

MaxGVW: 80,000

Received:

Weighmaster: Colleen LeSage

P/D Status: Deliver

Cust:

Customer Copy Scale: 1

By acceptance of this ticket (with or without signature), driver accepts on behalf of themselves/their employer sole responsibility to ensure that the load received is within the weight limit authorized by law and shall hold seller harmless against any and all claims with respect to same CURB DELIVERY ONLY. NOT RESPONSIBLE FOR ANY DAMAGE BEYOND CURB.



Plant: 32411

Berlin

368 New Brooklyn Road
Berlin, NJ 08009
856-809-0142,

3/13/2017 07:21

In :

Customer: 8638404 THE AMBIENT GROUP LLC

Order : 950949 Camden, NJ. ABC Barrel Project

P.O. :

Tkt. No. 1006027400

Product 114203

Bank Run

S.O. Info: Camden, NJ.

Ship Ref: 327 N. Front St



	Pounds	Kilo
Gross	78,000	35,380
Tare	28,180 *	12,782
Net	49,820	22,598

24.91 Ton 22.60

* Predetermined Tare

	UNIT	TOTALS
Material:		
Freight:		
Tax:		
Fee / Fuel:		
Other Chrg: No		

Today Tons:	73.09	Loads:
Tons To Date:	4,226.12	3
Today Tonnes	66.31	
Tonnes To Date:	3,833.87	

Carrier : 8040648 GJ SCOTT LLC

Vehicle: GS16 GS16

License: AT639K

MaxGVW: 80,000

Received: _____

Weighmaster: Colleen LeSage

Cust: _____

P/D Status: Deliver

Customer Do Not Accept [2] Scale: 1

By acceptance of this ticket (with or without signature), driver accepts on behalf of themselves/their employer sole responsibility to ensure that the load received is within the weight limit authorized by law and shall hold seller harmless against any and all claims with respect to same CURB DELIVERY ONLY. NOT RESPONSIBLE FOR ANY DAMAGE BEYOND CURB.



Plant: 32411

Berlin

368 New Brooklyn Road
Berlin, NJ 08009
856-809-0142,

3/13/2017 08:14

In : 7:51:36

Customer: 8638404 THE AMBIENT GROUP LLC

Order : 950949 Camden, NJ. ABC Barrel Project

P.O. :

Tkt. No. 1006027403

Product 114203

Bank Run

S.O. Info: Camden, NJ.

Ship Ref: 327 N. Front St



	Pounds	Kilo
Gross	72,680	32,967
Tare	24,560	11,140
Net	48,120	21,827

24.06 Ton 21.83

	UNIT	TOTALS
Material:		
Freight:		
Tax:		
Fee / Fuel:		
Other Chrg: No		

Today Tons:	97.15	Loads:
Tons To Date:	4,250.18	4
Today Tonnes	88.13	
Tonnes To Date:	3,855.70	

Carrier : 2347198 RAIO CONTRACTING & MATE

Vehicle: RO227 Raio

License: AR332D

MaxGVW: 80,000

Received: _____

Weighmaster: Colleen LeSage

Cust: _____

P/D Status: Deliver

Customer Do Not Accept [2] Scale: 1

By acceptance of this ticket (with or without signature), driver accepts on behalf of themselves/their employer sole responsibility to ensure that the load received is within the weight limit authorized by law and shall hold seller harmless against any and all claims with respect to same CURB DELIVERY ONLY. NOT RESPONSIBLE FOR ANY DAMAGE BEYOND CURB.



Plant: 32411

Berlin

368 New Brooklyn Road
Berlin, NJ 08009
856-809-0142,

3/13/2017 08:19

In: 7:51:03

Customer: 8638404

THE AMBIENT GROUP LLC

Order: 950949

Camden, NJ. ABC Barrel Project

Tkt. No. 1006027404

P.O.:



Product 114203

Bank Run

S.O. Info: Camden, NJ.

Ship Ref: 327 N. Front St

	Pounds	Kilo
Gross	73,140	33,176
Tare	25,540	11,585
Net	47,600	21,591

23.80 Ton. 21.59

UNIT	TOTALS
Material:	
Freight:	
Tax:	
Fee / Fuel:	
Other Chrg: No	

Today Tons:	120.95	Loads:
Tons To Date:	4,273.98	5
Today Tonnes	109.72	
Tonnes To Date:	3,877.29	

Carrier : 2347198 RAIO CONTRACTING & MATE

Vehicle: RO206

AL125T

License: AL125T

MaxGVW: 80,000

Received:

Cust:

Weighmaster: Colleen LeSage

P/D Status: Deliver

Customer Do Not Accept [1] Scale: 1

By acceptance of this ticket (with or without signature), driver accepts on behalf of themselves/their employer sole responsibility to ensure that the load received is within the weight limit authorized by law and shall hold seller harmless against any and all claims with respect to same CURB DELIVERY ONLY .NOT RESPONSIBLE FOR ANY DAMAGE BEYOND CURB.



Plant: 32411

Berlin

368 New Brooklyn Road
Berlin, NJ 08009
856-809-0142,

3/13/2017 08:23

In: 8:06:18

Customer: 8638404

THE AMBIENT GROUP LLC

Order: 950949

Camden, NJ. ABC Barrel Project

Tkt. No. 1006027405

P.O.:



Product 114203

Bank Run

S.O. Info: Camden, NJ.

Ship Ref: 327 N. Front St

	Pounds	Kilo
Gross	73,340	33,266
Tare	24,680	11,195
Net	48,660	22,072

24.33 Ton 22.07

UNIT	TOTALS
Material:	
Freight:	
Tax:	
Fee / Fuel:	
Other Chrg: No	

Today Tons:	145.28	Loads:
Tons To Date:	4,298.31	6
Today Tonnes	131.80	
Tonnes To Date:	3,899.36	

Carrier : 2347198 RAIO CONTRACTING & MATE

Vehicle: RO228

Raio

License: AR331D

MaxGVW: 80,000

Received:

Cust:

Weighmaster: Colleen LeSage

P/D Status: Deliver

Customer Copy Scale: 1

By acceptance of this ticket (with or without signature), driver accepts on behalf of themselves/their employer sole responsibility to ensure that the load received is within the weight limit authorized by law and shall hold seller harmless against any and all claims with respect to same CURB DELIVERY ONLY .NOT RESPONSIBLE FOR ANY DAMAGE BEYOND CURB.



Plant: 32411

Berlin

368 New Brooklyn Road
Berlin, NJ 08009
856-809-0142.

3/13/2017 09:05

In :

Customer: 8638404 THE AMBIENT GROUP LLC

Order : 950949 Camden, NJ. ABC Barrel Project

P.O. :

Tkt. No. 1006027413

Product 114203

Bank Run

S.O. Info: Camden, NJ.

Ship Ref: 327 N. Front St



	Pounds	Kilo
Gross	77,380	35,099
Tare	28,020 *	12,710
Net	49,360	22,389

24.68 Ton 22.39

* Predetermined Tare

Today Tons:	169.96	Loads:
Tons To Date:	4,322.99	7
Today Tonnes	154.19	
Tonnes To Date:	3,921.75	

	UNIT	TOTALS
Material:		
Freight:		
Tax:		
Fee / Fuel:		
Other Chrg: No		

Carrier : 9249110 CLM CONTRACTING LLC

Vehicle: CLM6 CLM6

License: AT597T

MaxGVW: 80,000

Received:

Weighmaster: Colleen LeSage

Cust: _____

P/D Status: Deliver

By acceptance of this ticket (with or without signature), driver accepts on behalf of themselves/their employer sole responsibility to ensure that the load received is within the weight limit authorized by law and shall hold seller harmless against any and all claims with respect to same CURB DELIVERY ONLY. NOT RESPONSIBLE FOR ANY DAMAGE BEYOND CURB.

Customer Copy

Scale: 1



Plant: 32411

Berlin

368 New Brooklyn Road
Berlin, NJ 08009
856-809-0142.

3/13/2017 09:09

In :

Customer: 8638404 THE AMBIENT GROUP LLC

Order : 950949 Camden, NJ. ABC Barrel Project

P.O. :

Tkt. No. 1006027414

Product 114203

Bank Run

S.O. Info: Camden, NJ.

Ship Ref: 327 N. Front St



	Pounds	Kilo
Gross	76,360	34,636
Tare	27,380 *	12,419
Net	48,980	22,217

24.49 Ton 22.22

* Predetermined Tare

Today Tons:	194.45	Loads:
Tons To Date:	4,347.48	8
Today Tonnes	176.40	
Tonnes To Date:	3,943.97	

	UNIT	TOTALS
Material:		
Freight:		
Tax:		
Fee / Fuel:		
Other Chrg: No		

Carrier : 8040648 GJ SCOTT LLC

Vehicle: GS4 GS4

License: AJ118L

MaxGVW: 80,000

Received:

Weighmaster: Colleen LeSage

Cust: _____

P/D Status: Deliver

By acceptance of this ticket (with or without signature), driver accepts on behalf of themselves/their employer sole responsibility to ensure that the load received is within the weight limit authorized by law and shall hold seller harmless against any and all claims with respect to same CURB DELIVERY ONLY. NOT RESPONSIBLE FOR ANY DAMAGE BEYOND CURB.

Customer Do Not Accept [2]

Scale: 1



Plant: 32411

Berlin
368 New Brooklyn Road
Berlin, NJ 08009
856-809-0142,

3/13/2017 09:17 In:
Customer: 8638404 THE AMBIENT GROUP LLC
Order : 950949 Camden, NJ. ABC Barrel Project
P.O. :

Tkt. No. 1006027415



Product 114203
Bank Run
S.O. Info: Camden, NJ.
Ship Ref: 327 N. Front St

	Pounds	Kilo
Gross	79,140	35,897
Tare	28,180 *	12,782
Net	50,960	23,115
	25.48 Ton	23.12

* Predetermined Tare

	UNIT	TOTALS
Material:		
Freight:		
Tax:		
Fee / Fuel:		
Other Chrg: No		

Today Tons:	219.93	Loads:
Tons To Date:	4,372.96	9
Today Tonnes	199.52	
Tonnes To Date:	3,967.08	

Carrier : 8040648 GJ SCOTT LLC
Vehicle: GS16 GS16
License: AT639K
MaxGVW: 80,000

By acceptance of this ticket (with or without signature), driver accepts on behalf of themselves/their employer sole responsibility to ensure that the load received is within the weight limit authorized by law and shall hold seller harmless against any and all claims with respect to same CURB DELIVERY ONLY. NOT RESPONSIBLE FOR ANY DAMAGE BEYOND CURB.

Received: 
Weighmaster: Colleen LeSage

Cust: _____

P/D Status: Deliver

Customer Do Not Accept [2] Scale: 1



Plant: 32411

Berlin
368 New Brooklyn Road
Berlin, NJ 08009
856-809-0142,

3/13/2017 09:20 In: 8:50:42
Customer: 8638404 THE AMBIENT GROUP LLC
Order : 950949 Camden, NJ. ABC Barrel Project
P.O. :

Tkt. No. 1006027416



Product 114203
Bank Run
S.O. Info: Camden, NJ.
Ship Ref: 327 N. Front St

	Pounds	Kilo
Gross	76,580	34,736
Tare	26,720	12,120
Net	49,860	22,616
	24.93 Ton	22.62

	UNIT	TOTALS
Material:		
Freight:		
Tax:		
Fee / Fuel:		
Other Chrg: No		

Today Tons:	244.86	Loads:
Tons To Date:	4,397.89	10
Today Tonnes	222.13	
Tonnes To Date:	3,989.70	

Carrier : 8515471 CALLE TRUCKING LLC
Vehicle: CALLE10 CALLE10
License: AG56567
MaxGVW: 80,000

By acceptance of this ticket (with or without signature), driver accepts on behalf of themselves/their employer sole responsibility to ensure that the load received is within the weight limit authorized by law and shall hold seller harmless against any and all claims with respect to same CURB DELIVERY ONLY. NOT RESPONSIBLE FOR ANY DAMAGE BEYOND CURB.

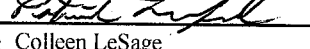
Received: 
Weighmaster: Colleen LeSage

Cust: _____

P/D Status: Deliver

Customer Do Not Accept [2] Scale: 1



Plant: 32411

Berlin
368 New Brooklyn Road
Berlin, NJ 08009
856-809-0142,

3/13/2017 10:22 In: 9:25:07
Customer: 8638404 THE AMBIENT GROUP LLC
Order: 950949 Camden, NJ. ABC Barrel Project
P.O.:

Tkt. No. 1006027421

Product 114203
Bank Run
S.O. Info: Camden, NJ.
Ship Ref: 327 N. Front St



	Pounds	Kilo
Gross	76,960	34,908
Tare	24,880	11,285
Net	52,080	23,623
	26.04 Ton	23.62

UNIT	TOTALS
Material:	
Freight:	
Tax:	
Fee / Fuel:	
Other Chrg: No	

Today Tons:	270.90	Loads:
Tons To Date:	4,423.93	11
Today Tonnes	245.76	
Tonnes To Date:	4,013.32	

Carrier: 8515471 CALLE TRUCKING LLC
Vehicle: CALLE5 AF49921
License: AF49921
MaxGVW: 80,000

By acceptance of this ticket (with or without signature), driver accepts on behalf of themselves/their employer sole responsibility to ensure that the load received is within the weight limit authorized by law and shall hold seller harmless against any and all claims with respect to same CURB DELIVERY ONLY. NOT RESPONSIBLE FOR ANY DAMAGE BEYOND CURB.

Received: _____ Cust: _____
Weighmaster: Colleen LeSage
P/D Status: Deliver Customer Do Not Accept [2] Scale: 1



Plant: 32411

Berlin
368 New Brooklyn Road
Berlin, NJ 08009
856-809-0142,

3/13/2017 10:30 In:
Customer: 8638404 THE AMBIENT GROUP LLC
Order: 950949 Camden, NJ. ABC Barrel Project
P.O.:

Tkt. No. 1006027422

Product 114203
Bank Run
S.O. Info: Camden, NJ.
Ship Ref: 327 N. Front St



	Pounds	Kilo
Gross	79,140	35,897
Tare	28,020 *	12,710
Net	51,120	23,188
	25.56 Ton	23.19

* Predetermined Tare

UNIT	TOTALS
Material:	
Freight:	
Tax:	
Fee / Fuel:	
Other Chrg: No	

Today Tons:	296.46	Loads:
Tons To Date:	4,449.49	12
Today Tonnes	268.94	
Tonnes To Date:	4,036.51	

Carrier: 9249110 CLM CONTRACTING LLC
Vehicle: CLM6 CLM6
License: AT597T
MaxGVW: 80,000

By acceptance of this ticket (with or without signature), driver accepts on behalf of themselves/their employer sole responsibility to ensure that the load received is within the weight limit authorized by law and shall hold seller harmless against any and all claims with respect to same CURB DELIVERY ONLY. NOT RESPONSIBLE FOR ANY DAMAGE BEYOND CURB.

Received: _____ Cust: _____
Weighmaster: Colleen LeSage
P/D Status: Deliver Customer Do Not Accept [2] Scale: 1



Plant: 32411

Berlin
368 New Brooklyn Road
Berlin, NJ 08009
856-809-0142.

3/13/2017 10:33 In :
Customer: 8638404 THE AMBIENT GROUP LLC
Order : 950949 Camden, NJ. ABC Barrel Project
P.O. :

Tkt. No. 1006027423

Product : 114203
Bank Run
S.O. Info: Camden, NJ.
Ship Ref: 327 N. Front St



	Pounds	Kilo
Gross	79,560	36,088
Tare	27,380 *	12,419
Net	52,180	23,668

26.09 Ton 23.67
* Predetermined Tare

Material:	UNIT	TOTALS
Freight:		
Tax:		
Fee / Fuel:		
Other Chrg: No		

Today Tons:	322.55	Loads:
Tons To Date:	4,475.58	13
Today Tonnes	292.61	
Tonnes To Date:	4,060.18	

Carrier : 8040648 GJ SCOTT LLC
Vehicle: GS4 GS4
License: AJ118L
MaxGVW: 80,000

By acceptance of this ticket (with or without signature), driver accepts on behalf of themselves/their employer sole responsibility to ensure that the load received is within the weight limit authorized by law and shall hold seller harmless against any and all claims with respect to same
CURB DELIVERY ONLY. NOT RESPONSIBLE FOR ANY DAMAGE BEYOND CURB.

Received: _____ Cust: _____

Weighmaster: Colleen LeSage

P/D Status: Deliver

Customer Do Not Accept [2] Scale: 1



Plant: 32411

Berlin
368 New Brooklyn Road
Berlin, NJ 08009
856-809-0142.

3/13/2017 10:35 In :
Customer: 8638404 THE AMBIENT GROUP LLC
Order : 950949 Camden, NJ. ABC Barrel Project
P.O. :

Tkt. No. 1006027424

Product : 114203
Bank Run
S.O. Info: Camden, NJ.
Ship Ref: 327 N. Front St



	Pounds	Kilo
Gross	78,700	35,698
Tare	28,180 *	12,782
Net	50,520	22,915

25.26 Ton 22.92
* Predetermined Tare

Material:	UNIT	TOTALS
Freight:		
Tax:		
Fee / Fuel:		
Other Chrg: No		

Today Tons:	347.81	Loads:
Tons To Date:	4,500.84	14
Today Tonnes	315.53	
Tonnes To Date:	4,083.09	

Carrier : 8040648 GJ SCOTT LLC
Vehicle: GS16 GS16
License: AT639K
MaxGVW: 80,000

By acceptance of this ticket (with or without signature), driver accepts on behalf of themselves/their employer sole responsibility to ensure that the load received is within the weight limit authorized by law and shall hold seller harmless against any and all claims with respect to same
CURB DELIVERY ONLY. NOT RESPONSIBLE FOR ANY DAMAGE BEYOND CURB.

Received: _____ Cust: _____

Weighmaster: Colleen LeSage

P/D Status: Deliver

Customer Do Not Accept [2] Scale: 1

Hanson

Plant: 32411

Berlin

368 New Brooklyn Road
Berlin, NJ 08009
856-809-0142,

3/13/2017 10:56

In:

Customer: 8638404 THE AMBIENT GROUP LLC

Order : 950949 Camden, NJ. ABC Barrel Project

P.O. :

Tkt. No. 1006027425

Product 114203

Bank Run

S.O. Info: Camden, NJ.

Ship Ref: 327 N. Front St



	Pounds	Kilo
Gross	79,300	35,970
Tare	26,720 *	12,120
Net	52,580	23,850

26.29 Ton 23.85

* Predetermined Tare

Material:	UNIT	TOTALS
Freight:		
Tax:		
Fee / Fuel:		
Other Chrg: No		

Today Tons:	374.10	Loads:
Tons To Date:	4,527.13	15
Today Tonnes	339.38	
Tonnes To Date:	4,106.94	

Carrier : 8515471 CALLE TRUCKING LLC

Vehicle: CALLE10 CALLE10

License: AG56567

MaxGVW: 80,000

Received: *[Signature]*

Weighmaster: Colleen LeSage

Cust: _____

P/D Status: Deliver

Customer Do Not Accept [2] Scale: 1

By acceptance of this ticket (with or without signature), driver accepts on behalf of themselves/their employer sole responsibility to ensure that the load received is within the weight limit authorized by law and shall hold seller harmless against any and all claims with respect to same CURB DELIVERY ONLY. NOT RESPONSIBLE FOR ANY DAMAGE BEYOND CURB.

Hanson

Plant: 32411

Berlin

368 New Brooklyn Road
Berlin, NJ 08009
856-809-0142,

3/13/2017 10:59

In: 10:43:19

Customer: 8638404 THE AMBIENT GROUP LLC

Order : 950949 Camden, NJ. ABC Barrel Project

P.O. :

Tkt. No. 1006027426

Product 114203

Bank Run

S.O. Info: Camden, NJ.

Ship Ref: 327 N. Front St



	Pounds	Kilo
Gross	76,120	34,527
Tare	24,600 *	11,158
Net	51,520	23,369

25.76 Ton 23.37

* Predetermined Tare

Material:	UNIT	TOTALS
Freight:		
Tax:		
Fee / Fuel:		
Other Chrg: No		

Today Tons:	399.86	Loads:
Tons To Date:	4,552.89	16
Today Tonnes	362.75	
Tonnes To Date:	4,130.31	

Carrier : 2347198 RAI0 CONTRACTING & MATE

Vehicle: RO213 Raio

License: AH445F

MaxGVW: 80,000

Received: *[Signature]* 2213

Weighmaster: Colleen LeSage

Cust: _____

P/D Status: Deliver

Customer Copy Scale: 1

By acceptance of this ticket (with or without signature), driver accepts on behalf of themselves/their employer sole responsibility to ensure that the load received is within the weight limit authorized by law and shall hold seller harmless against any and all claims with respect to same CURB DELIVERY ONLY. NOT RESPONSIBLE FOR ANY DAMAGE BEYOND CURB.



Plant: 32411

Berlin
368 New Brooklyn Road
Berlin, NJ 08009
856-809-0142,

3/13/2017 11:49 In :
Customer: 8638404 THE AMBIENT GROUP LLC
Order : 950949 Camden, NJ. ABC Barrel Project
P.O. :

Tkt. No. 1006027428

Product 114203
Bank Run
S.O. Info: Camden, NJ.
Ship Ref: 327 N. Front St



	Pounds	Kilo
Gross	77,340	35,081
Tare	24,880 *	11,285
Net	52,460	23,795

26.23 Ton 23.80
* Predetermined Tare

	UNIT	TOTALS
Material:		
Freight:		
Tax:		
Fee / Fuel:		
Other Chrg: No		

Today Tons:	426.09	Loads:
Tons To Date:	4,579.12	17
Today Tonnes	386.54	
Tonnes To Date:	4,154.11	

Carrier : 8515471 CALLE TRUCKING LLC
Vehicle: CALLE5 AF49921
License: AF49921
MaxGVW: 80,000

By acceptance of this ticket (with or without signature), driver accepts on behalf of themselves/their employer sole responsibility to ensure that the load received is within the weight limit authorized by law and shall hold seller harmless against any and all claims with respect to same CURB DELIVERY ONLY. NOT RESPONSIBLE FOR ANY DAMAGE BEYOND CURB.

Received: _____ Cust: _____

Weighmaster: Colleen LeSage

P/D Status: Deliver

Customer Do Not Accept [2] Scale: 1



Plant: 32411

Berlin
368 New Brooklyn Road
Berlin, NJ 08009
856-809-0142,

3/13/2017 11:55 In :
Customer: 8638404 THE AMBIENT GROUP LLC
Order : 950949 Camden, NJ. ABC Barrel Project
P.O. :

Tkt. No. 1006027429

Product 114203
Bank Run
S.O. Info: Camden, NJ.
Ship Ref: 327 N. Front St



	Pounds	Kilo
Gross	79,000	35,834
Tare	28,020 *	12,710
Net	50,980	23,124

25.49 Ton 23.12
* Predetermined Tare

	UNIT	TOTALS
Material:		
Freight:		
Tax:		
Fee / Fuel:		
Other Chrg: No		

Today Tons:	451.58	Loads:
Tons To Date:	4,604.61	18
Today Tonnes	409.67	
Tonnes To Date:	4,177.23	

Carrier : 9249110 CLM CONTRACTING LLC
Vehicle: CLM6 CLM6
License: AT597T
MaxGVW: 80,000

By acceptance of this ticket (with or without signature), driver accepts on behalf of themselves/their employer sole responsibility to ensure that the load received is within the weight limit authorized by law and shall hold seller harmless against any and all claims with respect to same CURB DELIVERY ONLY. NOT RESPONSIBLE FOR ANY DAMAGE BEYOND CURB.

Received: _____ Cust: _____

Weighmaster: Colleen LeSage

P/D Status: Deliver

Customer Copy Scale: 1



Plant: 32411

Berlin
368 New Brooklyn Road
Berlin, NJ 08009
856-809-0142,

3/13/2017 12:03 In:
Customer: 8638404 THE AMBIENT GROUP LLC
Order : 950949 Camden, NJ. ABC Barrel Project
P.O. :

Tkt. No. 1006027430

Product 114203
Bank Run
S.O. Info: Camden, NJ.
Ship Ref: 327 N. Front St



	Pounds	Kilo
Gross	78,280	35,507
Tare	27,380 *	12,419
Net	50,900	23,088

25.45 Ton 23.09
* Predetermined Tare

Today Tons:	477.03	Loads:
Tons To Date:	4,630.06	19
Today Tonnes	432.75	
Tonnes To Date:	4,200.32	

	UNIT	TOTALS
Material:		
Freight:		
Tax:		
Fee / Fuel:		
Other Chrg: No		

Carrier : 8040648 GJ SCOTT LLC
Vehicle: GS4 GS4
License: AJ118L
MaxGVW: 80,000

By acceptance of this ticket (with or without signature), driver accepts on behalf of themselves/their employer sole responsibility to ensure that the load received is within the weight limit authorized by law and shall hold seller harmless against any and all claims with respect to same CURB DELIVERY ONLY. NOT RESPONSIBLE FOR ANY DAMAGE BEYOND CURB.

Received: _____ Cust: _____

Weighmaster: Colleen LeSage

P/D Status: Deliver

Customer Do Not Accept [2] Scale: 1



Plant: 32411

Berlin
368 New Brooklyn Road
Berlin, NJ 08009
856-809-0142,

3/13/2017 12:08 In:
Customer: 8638404 THE AMBIENT GROUP LLC
Order : 950949 Camden, NJ. ABC Barrel Project
P.O. :

Tkt. No. 1006027431

Product 114203
Bank Run
S.O. Info: Camden, NJ.
Ship Ref: 327 N. Front St



	Pounds	Kilo
Gross	78,580	35,643
Tare	28,180 *	12,782
Net	50,400	22,861

25.20 Ton 22.86
* Predetermined Tare

Today Tons:	502.23	Loads:
Tons To Date:	4,655.26	20
Today Tonnes	455.62	
Tonnes To Date:	4,223.18	

	UNIT	TOTALS
Material:		
Freight:		
Tax:		
Fee / Fuel:		
Other Chrg: No		

Carrier : 8040648 GJ SCOTT LLC
Vehicle: GS16 GS16
License: AT639K
MaxGVW: 80,000

By acceptance of this ticket (with or without signature), driver accepts on behalf of themselves/their employer sole responsibility to ensure that the load received is within the weight limit authorized by law and shall hold seller harmless against any and all claims with respect to same CURB DELIVERY ONLY. NOT RESPONSIBLE FOR ANY DAMAGE BEYOND CURB.

Received: _____ Cust: _____

Weighmaster: Colleen LeSage

P/D Status: Deliver

Customer Copy Scale: 1

Hanson

Plant: 32411

Berlin
368 New Brooklyn Road
Berlin, NJ 08009
856-809-0142,

3/13/2017 12:30 In :
Customer: 8638404 THE AMBIENT GROUP LLC
Order : 950949 Camden, NJ. ABC Barrel Project
P.O. :

Tkt. No. 1006027433

Product 114203
Bank Run
S.O. Info: Camden, NJ.
Ship Ref: 327 N. Front St



	Pounds	Kilo
Gross	78,060	35,407
Tare	26,720 *	12,120
Net	51,340	23,287

25.67 Ton 23.29
* Predetermined Tare

Today Tons:	527.90	Loads:
Tons To Date:	4,680.93	21
Today Tonnes	478.90	
Tonnes To Date:	4,246.47	

	UNIT	TOTALS
Material:		
Freight:		
Tax:		
Fee / Fuel:		
Other Chrg: No		

By acceptance of this ticket (with or without signature), driver accepts on behalf of themselves/their employer sole responsibility to ensure that the load received is within the weight limit authorized by law and shall hold seller harmless against any and all claims with respect to same CURB DELIVERY ONLY. NOT RESPONSIBLE FOR ANY DAMAGE BEYOND CURB.

Carrier : 8515471 CALLE TRUCKING LLC
Vehicle: CALLE10 CALLE10
License: AG56567
MaxGVW: 80,000

Received: *Colleen LeSage* Cust: _____
Weighmaster: Colleen LeSage

P/D Status: Deliver

Customer Do Not Accept [2] Scale: 1

Hanson

Plant: 32411

Berlin
368 New Brooklyn Road
Berlin, NJ 08009
856-809-0142,

3/13/2017 12:32 In :
Customer: 8638404 THE AMBIENT GROUP LLC
Order : 950949 Camden, NJ. ABC Barrel Project
P.O. :

Tkt. No. 1006027434

Product 114203
Bank Run
S.O. Info: Camden, NJ.
Ship Ref: 327 N. Front St



	Pounds	Kilo
Gross	74,400	33,747
Tare	24,560 *	11,140
Net	49,840	22,607

24.92 Ton 22.61
* Predetermined Tare

Today Tons:	552.82	Loads:
Tons To Date:	4,705.85	22
Today Tonnes	501.51	
Tonnes To Date:	4,269.08	

	UNIT	TOTALS
Material:		
Freight:		
Tax:		
Fee / Fuel:		
Other Chrg: No		

By acceptance of this ticket (with or without signature), driver accepts on behalf of themselves/their employer sole responsibility to ensure that the load received is within the weight limit authorized by law and shall hold seller harmless against any and all claims with respect to same CURB DELIVERY ONLY. NOT RESPONSIBLE FOR ANY DAMAGE BEYOND CURB.

Carrier : 2347198 RAO CONTRACTING & MATE
Vehicle: RO227
License: AR332D
MaxGVW: 80,000

Received: *Colleen LeSage* Cust: _____
Weighmaster: Colleen LeSage

P/D Status: Deliver

Customer Copy Scale: 1



Plant: 32411

Berlin

368 New Brooklyn Road
Berlin, NJ 08009
856-809-0142.

3/13/2017 13:19

In :

Customer: 8638404 THE AMBIENT GROUP LLC

Order : 950949 Camden, NJ. ABC Barrel Project

P.O. :

Tkt. No. 1006027436

Product 114203

Bank Run

S.O. Info: Camden, NJ.

Ship Ref: 327 N. Front St



	Pounds	Kilo
Gross	77,260	35,045
Tare	24,880 *	11,285
Net	52,380	23,759

26.19 Ton 23.76

* Predetermined Tare

Today Tons:	579.01	Loads:
Tons To Date:	4,732.04	23
Today Tonnes	525.27	
Tonnes To Date:	4,292.83	

	UNIT	TOTALS
Material:		
Freight:		
Tax:		
Fee / Fuel:		
Other Chrg: No		

Carrier : 8515471 CALLE TRUCKING LLC

Vehicle: CALLES AF49921

License: AF49921

MaxGVW: 80,000

Received: _____

Weighmaster: Colleen LeSage

Cust: _____

P/D Status: Deliver

Customer Copy

Scale: 1

By acceptance of this ticket (with or without signature), driver accepts on behalf of themselves/their employer sole responsibility to ensure that the load received is within the weight limit authorized by law and shall hold seller harmless against any and all claims with respect to same CURB DELIVERY ONLY. NOT RESPONSIBLE FOR ANY DAMAGE BEYOND CURB.



Plant: 32411

Berlin

368 New Brooklyn Road
Berlin, NJ 08009
856-809-0142.

3/13/2017 13:33

In :

Customer: 8638404 THE AMBIENT GROUP LLC

Order : 950949 Camden, NJ. ABC Barrel Project

P.O. :

Tkt. No. 1006027437

Product 114203

Bank Run

S.O. Info: Camden, NJ.

Ship Ref: 327 N. Front St



	Pounds	Kilo
Gross	77,360	35,090
Tare	28,020 *	12,710
Net	49,340	22,380

24.67 Ton 22.38

* Predetermined Tare

Today Tons:	603.68	Loads:
Tons To Date:	4,756.71	24
Today Tonnes	547.65	
Tonnes To Date:	4,315.21	

	UNIT	TOTALS
Material:		
Freight:		
Tax:		
Fee / Fuel:		
Other Chrg: No		

Carrier : 9249110 CLM CONTRACTING LLC

Vehicle: CLM6 CLM6

License: AT597T

MaxGVW: 80,000

Received: _____

Weighmaster: Colleen LeSage

Cust: _____

P/D Status: Deliver

Customer Do Not Accept [2]

Scale: 1

By acceptance of this ticket (with or without signature), driver accepts on behalf of themselves/their employer sole responsibility to ensure that the load received is within the weight limit authorized by law and shall hold seller harmless against any and all claims with respect to same CURB DELIVERY ONLY. NOT RESPONSIBLE FOR ANY DAMAGE BEYOND CURB.



Plant: 32411

Berlin
368 New Brooklyn Road
Berlin, NJ 08009
856-809-0142

3/13/2017 13:36 In :
Customer: 8638404 THE AMBIENT GROUP LLC
Order : 950949 Camden, NJ. ABC Barrel Project
P.O. :

Tkt. No. 1006027438

Product 114203
Bank Run
S.O. Info: Camden, NJ.
Ship Ref: 327 N. Front St



	Pounds	Kilo
Gross	78,680	35,689
Tare	27,380 *	12,419
Net	51,300	23,269

25.65 Ton 23.27

* Predetermined Tare

Material:	UNIT	TOTALS
Freight:		
Tax:		
Fee / Fuel:		
Other Chrg: No		

Today Tons:	629.33	Loads:
Tons To Date:	4,782.36	25
Today Tonnes	570.92	
Tonnes To Date:	4,338.48	

Carrier : 8040648 GJ SCOTT LLC
Vehicle: GS4 GS4
License: AJ118L
MaxGVW: 80,000

By acceptance of this ticket (with or without signature), driver accepts on behalf of themselves/their employer sole responsibility to ensure that the load received is within the weight limit authorized by law and shall hold seller harmless against any and all claims with respect to same CURB DELIVERY ONLY. NOT RESPONSIBLE FOR ANY DAMAGE BEYOND CURB.

Received: _____ Cust: _____

Weighmaster: Colleen LeSage

P/D Status: Deliver

Customer Do Not Accept [2] Scale: 1



Plant: 32411

Berlin
368 New Brooklyn Road
Berlin, NJ 08009
856-809-0142

3/13/2017 13:49 In :
Customer: 8638404 THE AMBIENT GROUP LLC
Order : 950949 Camden, NJ. ABC Barrel Project
P.O. :

Tkt. No. 1006027439

Product 114203
Bank Run
S.O. Info: Camden, NJ.
Ship Ref: 327 N. Front St



	Pounds	Kilo
Gross	79,400	36,015
Tare	28,180 *	12,782
Net	51,220	23,233

25.61 Ton 23.23

* Predetermined Tare

Material:	UNIT	TOTALS
Freight:		
Tax:		
Fee / Fuel:		
Other Chrg: No		

Today Tons:	654.94	Loads:
Tons To Date:	4,807.97	26
Today Tonnes	594.15	
Tonnes To Date:	4,361.72	

Carrier : 8040648 GJ SCOTT LLC
Vehicle: GS16 GS16
License: AT639K
MaxGVW: 80,000

By acceptance of this ticket (with or without signature), driver accepts on behalf of themselves/their employer sole responsibility to ensure that the load received is within the weight limit authorized by law and shall hold seller harmless against any and all claims with respect to same CURB DELIVERY ONLY. NOT RESPONSIBLE FOR ANY DAMAGE BEYOND CURB.

Received: _____ Cust: _____

Weighmaster: Colleen LeSage

P/D Status: Deliver

Customer Do Not Accept [2] Scale: 1

3/13/2017 14:01 In:

Customer: 8638404 THE AMBIENT GROUP LLC

Order : 950949 Camden, NJ. ABC Barrel Project

P.O. :

Tkt. No. 1006027440

Product 114203

Bank Run

S.O. Info: Camden, NJ.

Ship Ref: 327 N. Front St



	Pounds	Kilo
Gross	78,280	35,507
Tare	26,720 *	12,120
Net	51,560	23,387

25.78 Ton 23.39

* Predetermined Tare

Today Tons:	680.72	Loads:
Tons To Date:	4,833.75	27
Today Tonnes	617.54	
Tonnes To Date:	4,385.10	

	UNIT	TOTALS
Material:		
Freight:		
Tax:		
Fee / Fuel:		
Other Chrg: No		

By acceptance of this ticket (with or without signature), driver accepts on behalf of themselves/their employer sole responsibility to ensure that the load received is within the weight limit authorized by law and shall hold seller harmless against any and all claims with respect to same
CURB DELIVERY ONLY .NOT RESPONSIBLE FOR ANY DAMAGE BEYOND CURB.

Carrier : 8515471 CALLE TRUCKING LLC

Vehicle: CALLE10 CALLE10

License: AG56567

MaxGVW: 80,000

Received: *Colleen LeSage*

Weighmaster: Colleen LeSage

Cust: _____

P/D Status: Deliver

Customer Do Not Accept [3] Scale: 1



Plant: 32411

Berlin
368 New Brooklyn Road
Berlin, NJ 08009
856-809-0142

3/16/2017 07:20 In: 6:45:18
Customer: 8638404 THE AMBIENT GROUP LLC
Order : 950949 Camden, NJ. ABC Barrel Project
P.O. :

Tkt. No. 1006027444



Product 114203
Bank Run
S.O. Info: Camden, NJ.
Ship Ref: 327 N. Front St

	Pounds	Kilo
Gross	78,560	35,634
Tare	27,960	12,682
Net	50,600	22,952
	25.30 Ton	22.95

	UNIT	TOTALS
Material:		
Freight:		
Tax:		
Fee / Fuel:		
Other Chrg: No		

Today Tons:	25.30	Loads:
Tons To Date:	4,859.05	1
Today Tonnes	22.95	
Tonnes To Date:	4,408.06	

Carrier : 8040648 GJ SCOTT LLC
Vehicle: GS16 GS16
License: AT639K
MaxGVW: 80,000

By acceptance of this ticket (with or without signature), driver accepts on behalf of themselves/their employer sole responsibility to ensure that the load received is within the weight limit authorized by law and shall hold seller harmless against any and all claims with respect to same CURB DELIVERY ONLY. NOT RESPONSIBLE FOR ANY DAMAGE BEYOND CURB.

Received:
Weighmaster: Colleen LeSage

Cust: _____

P/D Status: Deliver

Customer Do Not Accept [2] Scale: 1



Plant: 32411

Berlin
368 New Brooklyn Road
Berlin, NJ 08009
856-809-0142

3/16/2017 07:23 In: 6:52:45
Customer: 8638404 THE AMBIENT GROUP LLC
Order : 950949 Camden, NJ. ABC Barrel Project
P.O. :

Tkt. No. 1006027445



Product 114203
Bank Run
S.O. Info: Camden, NJ.
Ship Ref: 327 N. Front St

	Pounds	Kilo
Gross	78,440	35,580
Tare	28,860	13,091
Net	49,580	22,489
	24.79 Ton	22.49

	UNIT	TOTALS
Material:		
Freight:		
Tax:		
Fee / Fuel:		
Other Chrg: No		

Today Tons:	50.09	Loads:
Tons To Date:	4,883.84	2
Today Tonnes	45.44	
Tonnes To Date:	4,430.55	

Carrier : 8040648 GJ SCOTT LLC
Vehicle: GS14 GS14
License: As672T
MaxGVW: 80,000

By acceptance of this ticket (with or without signature), driver accepts on behalf of themselves/their employer sole responsibility to ensure that the load received is within the weight limit authorized by law and shall hold seller harmless against any and all claims with respect to same CURB DELIVERY ONLY. NOT RESPONSIBLE FOR ANY DAMAGE BEYOND CURB.

Received:
Weighmaster: Colleen LeSage

Cust: _____

P/D Status: Deliver

Customer Copy Scale: 1



Plant: 32411

Berlin

368 New Brooklyn Road
Berlin, NJ 08009
856-809-0142

3/16/2017 08:58

In:

Customer: 8638404 THE AMBIENT GROUP LLC

Order: 950949 Camden, NJ. ABC Barrel Project

P.O.:

Tkt. No. 1006027452

Product 114203

Bank Run

S.O. Info: Camden, NJ.

Ship Ref: 327 N. Front St



	Pounds	Kilo
Gross	77,920	35,344
Tare	27,960 *	12,682
Net	49,960	22,661

24.98 Ton 22.66

* Predetermined Tare

Today Tons:	75.07	Loads:
Tons To Date:	4,908.82	3
Today Tonnes	68.10	
Tonnes To Date:	4,453.21	

	UNIT	TOTALS
Material:		
Freight:		
Tax:		
Fee / Fuel:		
Other Chrg: No		

Carrier: 8040648 GJ SCOTT LLC

Vehicle: GS16 GS16

License: AT639K

MaxGVW: 80,000

Received:

Weighmaster: Colleen LeSage

Cust:

P/D Status: Deliver

Customer Copy

Scale: 1

By acceptance of this ticket (with or without signature), driver accepts on behalf of themselves/their employer sole responsibility to ensure that the load received is within the weight limit authorized by law and shall hold seller harmless against any and all claims with respect to same CURB DELIVERY ONLY. NOT RESPONSIBLE FOR ANY DAMAGE BEYOND CURB.



Plant: 32411

Berlin

368 New Brooklyn Road
Berlin, NJ 08009
856-809-0142

3/16/2017 09:00

In:

Customer: 8638404 THE AMBIENT GROUP LLC

Order: 950949 Camden, NJ. ABC Barrel Project

P.O.:

Tkt. No. 1006027453

Product 114203

Bank Run

S.O. Info: Camden, NJ.

Ship Ref: 327 N. Front St



	Pounds	Kilo
Gross	78,720	35,707
Tare	28,860 *	13,091
Net	49,860	22,616

24.93 Ton 22.62

* Predetermined Tare

Today Tons:	100.00	Loads:
Tons To Date:	4,933.75	4
Today Tonnes	90.72	
Tonnes To Date:	4,475.82	

	UNIT	TOTALS
Material:		
Freight:		
Tax:		
Fee / Fuel:		
Other Chrg: No		

Carrier: 8040648 GJ SCOTT LLC

Vehicle: GS14 GS14

License: As672T

MaxGVW: 80,000

Received:

Weighmaster: Colleen LeSage

Cust:

P/D Status: Deliver

Customer Do Not Accept [2]

Scale: 1

By acceptance of this ticket (with or without signature), driver accepts on behalf of themselves/their employer sole responsibility to ensure that the load received is within the weight limit authorized by law and shall hold seller harmless against any and all claims with respect to same CURB DELIVERY ONLY. NOT RESPONSIBLE FOR ANY DAMAGE BEYOND CURB.



Plant: 32411

Berlin
368 New Brooklyn Road
Berlin, NJ 08009
856-809-0142

3/16/2017 10:15 In:
Customer: 8638404 THE AMBIENT GROUP LLC
Order : 950949 Camden, NJ. ABC Barrel Project
P.O. :

Tkt. No. 1006027454



Product 114203
Bank Run
S.O. Info: Camden, NJ.
Ship Ref: 327 N. Front St

	Pounds	Kilo
Gross	79,280	35,961
Tare	27,960 *	12,682
Net	51,320	23,278

25.66 Ton 23.28

* Predetermined Tare

	UNIT	TOTALS
Material:		
Freight:		
Tax:		
Fee / Fuel:		
Other Chrg: No		

Today Tons:	125.66	Loads:
Tons To Date:	4,959.41	5
Today Tonnes	114.00	
Tonnes To Date:	4,499.10	

Carrier : 8040648 GJ SCOTT LLC
Vehicle: GS16 GS16
License: AT639K
MaxGVW: 80,000

By acceptance of this ticket (with or without signature), driver accepts on behalf of themselves/their employer sole responsibility to ensure that the load received is within the weight limit authorized by law and shall hold seller harmless against any and all claims with respect to same CURB DELIVERY ONLY. NOT RESPONSIBLE FOR ANY DAMAGE BEYOND CURB.

Received: _____

Cust: _____

Weighmaster: Colleen LeSage

P/D Status: Deliver

Customer Do Not Accept [2] Scale: 1



Plant: 32411

Berlin
368 New Brooklyn Road
Berlin, NJ 08009
856-809-0142

3/16/2017 10:22 In:
Customer: 8638404 THE AMBIENT GROUP LLC
Order : 950949 Camden, NJ. ABC Barrel Project
P.O. :

Tkt. No. 1006027455



Product 114203
Bank Run
S.O. Info: Camden, NJ.
Ship Ref: 327 N. Front St

	Pounds	Kilo
Gross	79,340	35,988
Tare	28,860 *	13,091
Net	50,480	22,897

25.24 Ton 22.90

* Predetermined Tare

	UNIT	TOTALS
Material:		
Freight:		
Tax:		
Fee / Fuel:		
Other Chrg: No		

Today Tons:	150.90	Loads:
Tons To Date:	4,984.65	6
Today Tonnes	136.89	
Tonnes To Date:	4,522.00	

Carrier : 8040648 GJ SCOTT LLC
Vehicle: GS14 GS14
License: As672T
MaxGVW: 80,000

By acceptance of this ticket (with or without signature), driver accepts on behalf of themselves/their employer sole responsibility to ensure that the load received is within the weight limit authorized by law and shall hold seller harmless against any and all claims with respect to same CURB DELIVERY ONLY. NOT RESPONSIBLE FOR ANY DAMAGE BEYOND CURB.

Received: _____

Cust: _____

Weighmaster: Colleen LeSage

P/D Status: Deliver

Customer Copy Scale: 1



Plant: 32411

Berlin

368 New Brooklyn Road
Berlin, NJ 08009
856-809-0142

3/16/2017 11:41

In :

Customer: 8638404 THE AMBIENT GROUP LLC

Order : 950949 Camden, NJ. ABC Barrel Project

P.O. :

Tkt. No. 1006027459

Product 114203

Bank Run

S.O. Info: Camden, NJ.

Ship Ref: 327 N. Front St



	Pounds	Kilo
Gross	77,800	35,289
Tare	27,960 *	12,682
Net	49,840	22,607

24.92 Ton 22.61

* Predetermined Tare

Today Tons:	175.82	Loads:
Tons To Date:	5,009.57	7
Today Tonnes	159.50	
Tonnes To Date:	4,544.61	

	UNIT	TOTALS
Material:		
Freight:		
Tax:		
Fee / Fuel:		
Other Chrg: No		

Carrier : 8040648 GJ SCOTT LLC

Vehicle: GS16 GS16

License: AT639K

MaxGVW: 80,000

Received: _____

Weighmaster: Colleen LeSage

P/D Status: Deliver

Cust: _____

By acceptance of this ticket (with or without signature), driver accepts on behalf of themselves/their employer sole responsibility to ensure that the load received is within the weight limit authorized by law and shall hold seller harmless against any and all claims with respect to same CURB DELIVERY ONLY. NOT RESPONSIBLE FOR ANY DAMAGE BEYOND CURB.

Customer Copy

Scale: 1



Plant: 32411

Berlin

368 New Brooklyn Road
Berlin, NJ 08009
856-809-0142

3/16/2017 11:44

In :

Customer: 8638404 THE AMBIENT GROUP LLC

Order : 950949 Camden, NJ. ABC Barrel Project

P.O. :

Tkt. No. 1006027460

Product 114203

Bank Run

S.O. Info: Camden, NJ.

Ship Ref: 327 N. Front St



	Pounds	Kilo
Gross	79,020	35,843
Tare	28,860 *	13,091
Net	50,160	22,752

25.08 Ton 22.75

* Predetermined Tare

Today Tons:	200.90	Loads:
Tons To Date:	5,034.65	8
Today Tonnes	182.25	
Tonnes To Date:	4,567.36	

	UNIT	TOTALS
Material:		
Freight:		
Tax:		
Fee / Fuel:		
Other Chrg: No		

Carrier : 8040648 GJ SCOTT LLC

Vehicle: GS14 GS14

License: As672T

MaxGVW: 80,000

Received: _____

Weighmaster: Colleen LeSage

P/D Status: Deliver

Cust: _____

By acceptance of this ticket (with or without signature), driver accepts on behalf of themselves/their employer sole responsibility to ensure that the load received is within the weight limit authorized by law and shall hold seller harmless against any and all claims with respect to same CURB DELIVERY ONLY. NOT RESPONSIBLE FOR ANY DAMAGE BEYOND CURB.

Customer Do Not Accept [2]

Scale: 1



Plant: 32411

Berlin
368 New Brooklyn Road
Berlin, NJ 08009
856-809-0142

3/16/2017 13:10 In :
Customer: 8638404 THE AMBIENT GROUP LLC
Order : 950949 Camden, NJ. ABC Barrel Project
P.O. :

Tkt. No. 1006027462



Product 114203
Bank Run
S.O. Info: Camden, NJ.
Ship Ref: 327 N. Front St

	Pounds	Kilo
Gross	78,820	35,752
Tare	28,860 *	13,091
Net	49,960	22,661

24.98 Ton 22.66

* Predetermined Tare

UNIT	TOTALS
Material:	
Freight:	
Tax:	
Fee / Fuel:	
Other Chrg: No	

Today Tons:	225.88	Loads:	
Tons To Date:	5,059.63		9
Today Tonnes	204.91		
Tonnes To Date:	4,590.02		

By acceptance of this ticket (with or without signature), driver accepts on behalf of themselves/their employer sole responsibility to ensure that the load received is within the weight limit authorized by law and shall hold seller harmless against any and all claims with respect to same CURB DELIVERY ONLY. NOT RESPONSIBLE FOR ANY DAMAGE BEYOND CURB.

Carrier : 8040648 GJ SCOTT LLC
Vehicle: GS14 GS14
License: As672T
MaxGVW: 80,000

Received: _____

Cust: _____

Weighmaster: Colleen LeSage

P/D Status: Deliver

Customer Do Not Accept [2] Scale: 1



Plant: 32411

Berlin
368 New Brooklyn Road
Berlin, NJ 08009
856-809-0142

3/16/2017 13:12 In :
Customer: 8638404 THE AMBIENT GROUP LLC
Order : 950949 Camden, NJ. ABC Barrel Project
P.O. :

Tkt. No. 1006027463



Product 114203
Bank Run
S.O. Info: Camden, NJ.
Ship Ref: 327 N. Front St

	Pounds	Kilo
Gross	78,640	35,670
Tare	27,960 *	12,682
Net	50,680	22,988

25.34 Ton 22.99

* Predetermined Tare

UNIT	TOTALS
Material:	
Freight:	
Tax:	
Fee / Fuel:	
Other Chrg: No	

Today Tons:	251.22	Loads:	
Tons To Date:	5,084.97		10
Today Tonnes	227.90		
Tonnes To Date:	4,613.01		

By acceptance of this ticket (with or without signature), driver accepts on behalf of themselves/their employer sole responsibility to ensure that the load received is within the weight limit authorized by law and shall hold seller harmless against any and all claims with respect to same CURB DELIVERY ONLY. NOT RESPONSIBLE FOR ANY DAMAGE BEYOND CURB.

Carrier : 8040648 GJ SCOTT LLC
Vehicle: GS16 GS16
License: AT639K
MaxGVW: 80,000

Received: _____

Cust: _____

Weighmaster: Colleen LeSage

P/D Status: Deliver

Customer Do Not Accept [2] Scale: 1



Plant: 32411

Berlin

368 New Brooklyn Road
Berlin, NJ 08009
856-809-0142

3/17/2017 07:23 In: 6:32:43
Customer: 8638404 THE AMBIENT GROUP LLC
Order : 950949 Camden, NJ. ABC Barrel Project
P.O. :

Tkt. No. 1006027468

Product 114203
Bank Run
S.O. Info: Camden, NJ.
Ship Ref: 327 N. Front St



	Pounds	Kilo
Gross	77,860	35,317
Tare	26,160	11,866
Net	51,700	23,451
	25.85 Ton	23.45

	UNIT	TOTALS
Material:		
Freight:		
Tax:		
Fee / Fuel:		
Other Chrg: No		

Today Tons:	50.89	Loads:
Tons To Date:	5,135.86	2
Today Tonnes	46.17	
Tonnes To Date:	4,659.17	

Carrier : 2347809 ROBBINS & SONS HAULING IN
Vehicle: RY093 AS527V
License: AS527V
MaxGVW: 80,000

By acceptance of this ticket (with or without signature), driver accepts on behalf of themselves/their employer sole responsibility to ensure that the load received is within the weight limit authorized by law and shall holdseller harmless against any and all claims with respect to same CURB DELIVERY ONLY. NOT RESPONSIBLE FOR ANY DAMAGE BEYOND CURB.

Received: _____ Cust: _____
Weighmaster: Colleen LeSage

P/D Status: Deliver

Customer Copy

Scale: 1



Plant: 32411

Berlin

368 New Brooklyn Road
Berlin, NJ 08009
856-809-0142

3/17/2017 07:29 In: 6:33:21
Customer: 8638404 THE AMBIENT GROUP LLC
Order : 950949 Camden, NJ. ABC Barrel Project
P.O. :

Tkt. No. 1006027469

Product 114203
Bank Run
S.O. Info: Camden, NJ.
Ship Ref: 327 N. Front St



	Pounds	Kilo
Gross	78,600	35,652
Tare	26,540	12,038
Net	52,060	23,614
	26.03 Ton	23.61

	UNIT	TOTALS
Material:		
Freight:		
Tax:		
Fee / Fuel:		
Other Chrg: No		

Today Tons:	76.92	Loads:
Tons To Date:	5,161.89	3
Today Tonnes	69.78	
Tonnes To Date:	4,682.79	

Carrier : 2347032 ROCKY LOGIOVINO TRUCKIN
Vehicle: LR060 Rocky
License: AM637B
MaxGVW: 80,000

By acceptance of this ticket (with or without signature), driver accepts on behalf of themselves/their employer sole responsibility to ensure that the load received is within the weight limit authorized by law and shall holdseller harmless against any and all claims with respect to same CURB DELIVERY ONLY. NOT RESPONSIBLE FOR ANY DAMAGE BEYOND CURB.

Received: _____ Cust: _____
Weighmaster: Colleen LeSage

P/D Status: Deliver

Customer Copy

Scale: 1



Plant: 32411

Berlin
368 New Brooklyn Road
Berlin, NJ 08009
856-809-0142

3/17/2017 07:30 In: 7:09:12
Customer: 8638404 THE AMBIENT GROUP LLC
Order : 950949 Camden, NJ. ABC Barrel Project
P.O. :

Tkt. No. 1006027470



Product 114203
Bank Run
S.O. Info: Camden, NJ.
Ship Ref: 327 N. Front St

	Pounds	Kilo
Gross	77,440	35,126
Tare	26,460	12,002
Net	50,980	23,124
	25.49 Ton	23.12

	UNIT	TOTALS
Material:		
Freight:		
Tax:		
Fee / Fuel:		
Other Chrg: No		

Today Tons:	102.41	Loads:
Tons To Date:	5,187.38	4
Today Tonnes	92.90	
Tonnes To Date:	4,705.91	

Carrier : 2346970 GEORGE LAZOS TRUCKING
Vehicle: LG003 AS512W
License: AS512W
MaxGVW: 80,000

By acceptance of this ticket (with or without signature), driver accepts on behalf of themselves/their employer sole responsibility to ensure that the load received is within the weight limit authorized by law and shall hold seller harmless against any and all claims with respect to same CURB DELIVERY ONLY. NOT RESPONSIBLE FOR ANY DAMAGE BEYOND CURB.

Received: _____
Weighmaster: Colleen LeSage

Cust: _____

P/D Status: Deliver

Customer Do Not Accept [2] Scale: 1



Plant: 32411

Berlin
368 New Brooklyn Road
Berlin, NJ 08009
856-809-0142

3/17/2017 07:45 In: 6:33:31
Customer: 8638404 THE AMBIENT GROUP LLC
Order : 950949 Camden, NJ. ABC Barrel Project
P.O. :

Tkt. No. 1006027471



Product 114203
Bank Run
S.O. Info: Camden, NJ.
Ship Ref: 327 N. Front St

	Pounds	Kilo
Gross	79,160	35,906
Tare	24,960	11,322
Net	54,200	24,585
	27.10 Ton	24.58

	UNIT	TOTALS
Material:		
Freight:		
Tax:		
Fee / Fuel:		
Other Chrg: No		

Today Tons:	129.51	Loads:
Tons To Date:	5,214.48	5
Today Tonnes	117.49	
Tonnes To Date:	4,730.50	

Carrier : 8540415 S CUMMINS LLC
Vehicle: CUM17 Steve
License: AT979F
MaxGVW: 80,000

By acceptance of this ticket (with or without signature), driver accepts on behalf of themselves/their employer sole responsibility to ensure that the load received is within the weight limit authorized by law and shall hold seller harmless against any and all claims with respect to same CURB DELIVERY ONLY. NOT RESPONSIBLE FOR ANY DAMAGE BEYOND CURB.

Received: _____
Weighmaster: Colleen LeSage

Cust: _____

P/D Status: Deliver

Customer Do Not Accept [2] Scale: 1



Plant: 32411

Berlin
368 New Brooklyn Road
Berlin, NJ 08009
856-809-0142

3/17/2017 07:49 In: 6:32:31
Customer: 8638404 THE AMBIENT GROUP LLC
Order : 950949 Camden, NJ. ABC Barrel Project
P.O. :

Tkt. No. 1006027472

Product 114203
Bank Run
S.O. Info: Camden, NJ.
Ship Ref: 327 N. Front St



	Pounds	Kilo
Gross	77,560	35,181
Tare	27,160	12,320
Net	50,400	22,861
	25.20 Ton	22.86

	UNIT	TOTALS
Material:		
Freight:		
Tax:		
Fee / Fuel:		
Other Chrg: No		

Today Tons:	154.71	Loads:
Tons To Date:	5,239.68	6
Today Tonnes	140.35	
Tonnes To Date:	4,753.36	

Carrier : 2347631 R A DIMARIA
Vehicle: DY026 DiMaria
License: AS200U
MaxGVW: 80,000
Received: _____
Weighmaster: Colleen LeSage

By acceptance of this ticket (with or without signature), driver accepts on behalf of themselves/their employer sole responsibility to ensure that the load received is within the weight limit authorized by law and shall hold seller harmless against any and all claims with respect to same CURB DELIVERY ONLY. NOT RESPONSIBLE FOR ANY DAMAGE BEYOND CURB.

Cust: _____

P/D Status: Deliver

Customer Do Not Accept [2] Scale: 1



Plant: 32411

Berlin
368 New Brooklyn Road
Berlin, NJ 08009
856-809-0142

3/17/2017 08:30 In: 6:32:57
Customer: 8638404 THE AMBIENT GROUP LLC
Order : 950949 Camden, NJ. ABC Barrel Project
P.O. :

Tkt. No. 1006027479

Product 114203
Bank Run
S.O. Info: Camden, NJ.
Ship Ref: 327 N. Front St



	Pounds	Kilo
Gross	78,740	35,716
Tare	24,520	11,122
Net	54,220	24,594
	27.11 Ton	24.59

	UNIT	TOTALS
Material:		
Freight:		
Tax:		
Fee / Fuel:		
Other Chrg: No		

Today Tons:	181.82	Loads:
Tons To Date:	5,266.79	7
Today Tonnes	164.94	
Tonnes To Date:	4,777.95	

Carrier : 2347024 JOHN MAYVILLE
Vehicle: MI488 John Mayville
License: AF420W
MaxGVW: 80,000
Received: _____
Weighmaster: Colleen LeSage

By acceptance of this ticket (with or without signature), driver accepts on behalf of themselves/their employer sole responsibility to ensure that the load received is within the weight limit authorized by law and shall hold seller harmless against any and all claims with respect to same CURB DELIVERY ONLY. NOT RESPONSIBLE FOR ANY DAMAGE BEYOND CURB.

Cust: _____

P/D Status: Deliver

Customer Do Not Accept [2] Scale: 1



Plant: 32411

Berlin
368 New Brooklyn Road
Berlin, NJ 08009
856-809-0142

3/17/2017 09:07 In:
Customer: 8638404 THE AMBIENT GROUP LLC
Order : 950949 Camden, NJ. ABC Barrel Project
P.O. :

Tkt. No. 1006027485

Product 114203
Bank Run
S.O. Info: Camden, NJ.
Ship Ref: 327 N. Front St



	Pounds	Kilo
Gross	78,500	35,607
Tare	26,160 *	11,866
Net	52,340	23,741

26.17 Ton 23.74

* Predetermined Tare

	UNIT	TOTALS
Material:		
Freight:		
Tax:		
Fee / Fuel:		
Other Chrg: No		

Today Tons:	207.99	Loads:
Tons To Date:	5,292.96	8
Today Tonnes	188.69	
Tonnes To Date:	4,801.69	

Carrier : 2347809 ROBBINS & SONS HAULING IN
Vehicle: RY093 AS527V
License: AS527V
MaxGVW: 80,000

By acceptance of this ticket (with or without signature), driver accepts on behalf of themselves/their employer sole responsibility to ensure that the load received is within the weight limit authorized by law and shall hold seller harmless against any and all claims with respect to same CURB DELIVERY ONLY. NOT RESPONSIBLE FOR ANY DAMAGE BEYOND CURB.

Received: _____ Cust: _____

Weighmaster: Colleen LeSage

P/D Status: Deliver

Customer Do Not Accept [2] Scale: 1



Plant: 32411

Berlin
368 New Brooklyn Road
Berlin, NJ 08009
856-809-0142

3/17/2017 09:26 In:
Customer: 8638404 THE AMBIENT GROUP LLC
Order : 950949 Camden, NJ. ABC Barrel Project
P.O. :

Tkt. No. 1006027486

Product 114203
Bank Run
S.O. Info: Camden, NJ.
Ship Ref: 327 N. Front St



	Pounds	Kilo
Gross	78,660	35,680
Tare	26,460 *	12,002
Net	52,200	23,678

26.10 Ton 23.68

* Predetermined Tare

	UNIT	TOTALS
Material:		
Freight:		
Tax:		
Fee / Fuel:		
Other Chrg: No		

Today Tons:	234.09	Loads:
Tons To Date:	5,319.06	9
Today Tonnes	212.36	
Tonnes To Date:	4,825.37	

Carrier : 2346970 GEORGE LAZOS TRUCKING
Vehicle: LG003 AS512W
License: AS512W
MaxGVW: 80,000

By acceptance of this ticket (with or without signature), driver accepts on behalf of themselves/their employer sole responsibility to ensure that the load received is within the weight limit authorized by law and shall hold seller harmless against any and all claims with respect to same CURB DELIVERY ONLY. NOT RESPONSIBLE FOR ANY DAMAGE BEYOND CURB.

Received: _____ Cust: _____

Weighmaster: Colleen LeSage

P/D Status: Deliver

Customer Do Not Accept [3] Scale: 1



Plant: 32411

Berlin

368 New Brooklyn Road
Berlin, NJ 08009
856-809-0142

3/17/2017 09:42 In :
Customer: 8638404 THE AMBIENT GROUP LLC
Order : 950949 Camden, NJ. ABC Barrel Project
P.O. :

Tkt. No. 1006027487

Product 114203
Bank Run
S.O. Info: Camden, NJ.
Ship Ref: 327 N. Front St



	Pounds	Kilo
Gross	79,140	35,897
Tare	26,540 *	12,038
Net	52,600	23,859

26.30 Ton 23.86

* Predetermined Tare

	UNIT	TOTALS
Material:		
Freight:		
Tax:		
Fee / Fuel:		
Other Chrg:	No	

Today Tons:	260.39	Loads:
Tons To Date:	5,345.36	10
Today Tonnes	236.22	
Tonnes To Date:	4,849.23	

Carrier : 2347032 ROCKY LOGIOVINO TRUCKIN
Vehicle: LR060 Rocky
License: AM637B
MaxGVW: 80,000

By acceptance of this ticket (with or without signature), driver accepts on behalf of themselves/their employer sole responsibility to ensure that the load received is within the weight limit authorized by law and shall hold seller harmless against any and all claims with respect to same CURB DELIVERY ONLY. NOT RESPONSIBLE FOR ANY DAMAGE BEYOND CURB.

Received: _____
Weighmaster: Colleen LeSage

Cust: _____

P/D Status: Deliver

Customer Copy

Scale: 1



Plant: 32411

Berlin

368 New Brooklyn Road
Berlin, NJ 08009
856-809-0142

3/17/2017 09:43 In :
Customer: 8638404 THE AMBIENT GROUP LLC
Order : 950949 Camden, NJ. ABC Barrel Project
P.O. :

Tkt. No. 1006027488

Product 114203
Bank Run
S.O. Info: Camden, NJ.
Ship Ref: 327 N. Front St



	Pounds	Kilo
Gross	77,660	35,226
Tare	27,160 *	12,320
Net	50,500	22,906

25.25 Ton 22.91

* Predetermined Tare

	UNIT	TOTALS
Material:		
Freight:		
Tax:		
Fee / Fuel:		
Other Chrg:	No	

Today Tons:	285.64	Loads:
Tons To Date:	5,370.61	11
Today Tonnes	259.13	
Tonnes To Date:	4,872.14	

Carrier : 2347631 R A DIMARIA
Vehicle: DY026 DiMaria
License: AS200U
MaxGVW: 80,000

By acceptance of this ticket (with or without signature), driver accepts on behalf of themselves/their employer sole responsibility to ensure that the load received is within the weight limit authorized by law and shall hold seller harmless against any and all claims with respect to same CURB DELIVERY ONLY. NOT RESPONSIBLE FOR ANY DAMAGE BEYOND CURB.

Received: _____
Weighmaster: Colleen LeSage

Cust: _____

P/D Status: Deliver

Customer Do Not Accept [2]

Scale: 1



Plant: 32411

Berlin

368 New Brooklyn Road
Berlin, NJ 08009
856-809-0142

3/17/2017 09:45 In :
Customer: 8638404 THE AMBIENT GROUP LLC
Order : 950949 Camden, NJ. ABC Barrel Project
P.O. :

Tkt. No. 1006027489

Product 114203
Bank Run
S.O. Info: Camden, NJ.
Ship Ref: 327 N. Front St



	Pounds	Kilo
Gross	78,840	35,761
Tare	24,960 *	11,322
Net	53,880	24,440

26.94 Ton 24.44
* Predetermined Tare

	UNIT	TOTALS
Material:		
Freight:		
Tax:		
Fee / Fuel:		
Other Chrg: No		

Today Tons:	312.58	Loads:
Tons To Date:	5,397.55	12
Today Tonnes	283.57	
Tonnes To Date:	4,896.57	

Carrier : 8540415 S CUMMINS LLC
Vehicle: CUM17 Steve
License: AT979F
MaxGVW: 80,000

By acceptance of this ticket (with or without signature), driver accepts on behalf of themselves/their employer sole responsibility to ensure that the load received is within the weight limit authorized by law and shall hold seller harmless against any and all claims with respect to same CURB DELIVERY ONLY. NOT RESPONSIBLE FOR ANY DAMAGE BEYOND CURB.

Received: [Signature] Cust: _____
Weighmaster: Colleen LeSage

P/D Status: Deliver

Customer Copy

Scale: 1



Plant: 32411

Berlin

368 New Brooklyn Road
Berlin, NJ 08009
856-809-0142

3/17/2017 10:07 In :
Customer: 8638404 THE AMBIENT GROUP LLC
Order : 950949 Camden, NJ. ABC Barrel Project
P.O. :

Tkt. No. 1006027490

Product 114203
Bank Run
S.O. Info: Camden, NJ.
Ship Ref: 327 N. Front St



	Pounds	Kilo
Gross	79,680	36,142
Tare	24,520 *	11,122
Net	55,160	25,020

27.58 Ton 25.02
* Predetermined Tare

	UNIT	TOTALS
Material:		
Freight:		
Tax:		
Fee / Fuel:		
Other Chrg: No		

Today Tons:	340.16	Loads:
Tons To Date:	5,425.13	13
Today Tonnes	308.59	
Tonnes To Date:	4,921.60	

Carrier : 2347024 JOHN MAYVILLE
Vehicle: MI488 John Mayville
License: AF420W
MaxGVW: 80,000

By acceptance of this ticket (with or without signature), driver accepts on behalf of themselves/their employer sole responsibility to ensure that the load received is within the weight limit authorized by law and shall hold seller harmless against any and all claims with respect to same CURB DELIVERY ONLY. NOT RESPONSIBLE FOR ANY DAMAGE BEYOND CURB.

Received: _____ Cust: _____
Weighmaster: Colleen LeSage
P/D Status: Deliver

Customer Do Not Accept [1]

Scale: 1



Plant: 32411

Berlin

368 New Brooklyn Road
Berlin, NJ 08009
856-809-0142

3/17/2017 10:39

In :

Customer: 8638404 THE AMBIENT GROUP LLC

Order : 950949 Camden, NJ. ABC Barrel Project

P.O. :

Tkt. No. 1006027492

Product 114203



Bank Run

S.O. Info: Camden, NJ.

Ship Ref: 327 N. Front St

	Pounds	Kilo
Gross	78,740	35,716
Tare	26,160 *	11,866
Net	52,580	23,850

26.29 Ton 23.85

* Predetermined Tare

Material:	UNIT	TOTALS
Freight:		
Tax:		
Fee / Fuel:		
Other Chrg: No		

Today Tons:	341.41	Loads:
Tons To Date:	5,426.38	13
Today Tonnes	309.72	
Tonnes To Date:	4,922.73	

Carrier : 2347809 ROBBINS & SONS HAULING IN

Vehicle: RY093 AS527V

License: AS527V

MaxGVW: 80,000

Received: _____

Cust: _____

Weighmaster: Colleen LeSage

P/D Status: Deliver

Customer Do Not Accept [1] Scale: 1

By acceptance of this ticket (with or without signature), driver accepts on behalf of themselves/their employer sole responsibility to ensure that the load received is within the weight limit authorized by law and shall hold seller harmless against any and all claims with respect to same
CURB DELIVERY ONLY. NOT RESPONSIBLE FOR ANY DAMAGE BEYOND CURB.



Plant: 32411

Berlin

368 New Brooklyn Road
Berlin, NJ 08009
856-809-0142

3/17/2017 10:48

In :

Customer: 8638404 THE AMBIENT GROUP LLC

Order : 950949 Camden, NJ. ABC Barrel Project

P.O. :

Tkt. No. 1006027494

Product 114203



Bank Run

S.O. Info: Camden, NJ.

Ship Ref: 327 N. Front St

	Pounds	Kilo
Gross	78,960	35,816
Tare	26,460 *	12,002
Net	52,500	23,814

26.25 Ton 23.81

* Predetermined Tare

Material:	UNIT	TOTALS
Freight:		
Tax:		
Fee / Fuel:		
Other Chrg: No		

Today Tons:	367.66	Loads:
Tons To Date:	5,452.63	14
Today Tonnes	333.54	
Tonnes To Date:	4,946.54	

Carrier : 2346970 GEORGE LAZOS TRUCKING

Vehicle: LG003 AS512W

License: AS512W

MaxGVW: 80,000

Received: _____

Cust: _____

Weighmaster: Colleen LeSage

P/D Status: Deliver

Customer Do Not Accept [3] Scale: 1

By acceptance of this ticket (with or without signature), driver accepts on behalf of themselves/their employer sole responsibility to ensure that the load received is within the weight limit authorized by law and shall hold seller harmless against any and all claims with respect to same
CURB DELIVERY ONLY. NOT RESPONSIBLE FOR ANY DAMAGE BEYOND CURB.



Plant: 32411

Berlin
368 New Brooklyn Road
Berlin, NJ 08009
856-809-0142

3/17/2017 11:17

In :

Customer: 8638404 THE AMBIENT GROUP LLC

Order : 950949 Camden, NJ. ABC Barrel Project

P.O. :

Tkt. No. 1006027496



Product 114203

Bank Run

S.O. Info: Camden, NJ.

Ship Ref: 327 N. Front St

	Pounds	Kilo
Gross	77,640	35,217
Tare	27,160 *	12,320
Net	50,480	22,897

25.24 Ton 22.90

* Predetermined Tare

	UNIT	TOTALS
Material:		
Freight:		
Tax:		
Fee / Fuel:		
Other Chrg: No		

Today Tons:	392.90	Loads:
Tons To Date:	5,477.87	15
Today Tonnes	356.43	
Tonnes To Date:	4,969.44	

By acceptance of this ticket (with or without signature), driver accepts on behalf of themselves/their employer sole responsibility to ensure that the load received is within the weight limit authorized by law and shall hold seller harmless against any and all claims with respect to same CURB DELIVERY ONLY. NOT RESPONSIBLE FOR ANY DAMAGE BEYOND CURB.

Carrier : 2347631 R A DIMARIA

Vehicle: DY026 DiMaria

License: A8200U

MaxGVW: 80,000

Received:

Weighmaster: Colleen LeSage

Cust: _____

P/D Status: Deliver

Customer Do Not Accept [1] Scale: 1



Plant: 32411

Berlin
368 New Brooklyn Road
Berlin, NJ 08009
856-809-0142

3/17/2017 11:19

In :

Customer: 8638404 THE AMBIENT GROUP LLC

Order : 950949 Camden, NJ. ABC Barrel Project

P.O. :

Tkt. No. 1006027497



Product 114203

Bank Run

S.O. Info: Camden, NJ.

Ship Ref: 327 N. Front St

	Pounds	Kilo
Gross	77,720	35,253
Tare	26,540 *	12,038
Net	51,180	23,215

25.59 Ton 23.21

* Predetermined Tare

	UNIT	TOTALS
Material:		
Freight:		
Tax:		
Fee / Fuel:		
Other Chrg: No		

Today Tons:	418.49	Loads:
Tons To Date:	5,503.46	16
Today Tonnes	379.65	
Tonnes To Date:	4,992.65	

By acceptance of this ticket (with or without signature), driver accepts on behalf of themselves/their employer sole responsibility to ensure that the load received is within the weight limit authorized by law and shall hold seller harmless against any and all claims with respect to same CURB DELIVERY ONLY. NOT RESPONSIBLE FOR ANY DAMAGE BEYOND CURB.

Carrier : 2347032 ROCKY LOGIOVINO TRUCKIN

Vehicle: LR060 Rocky

License: AM637B

MaxGVW: 80,000

Received: _____

Weighmaster: Colleen LeSage

Cust: _____

P/D Status: Deliver

Customer Do Not Accept [3] Scale: 1



Plant: 32411

Berlin

368 New Brooklyn Road
Berlin, NJ 08009
856-809-0142

3/17/2017 11:23

In :

Customer: 8638404 THE AMBIENT GROUP LLC

Order : 950949 Camden, NJ. ABC Barrel Project

P.O. :

Tkt. No. 1006027498

Product 114203

Bank Run

S.O. Info: Camden, NJ.

Ship Ref: 327 N. Front St



	Pounds	Kilo
Gross	79,320	35,979
Tare	24,960 *	11,322
Net	54,360	24,657

27.18 Ton 24.66

* Predetermined Tare

	UNIT	TOTALS
Material:		
Freight:		
Tax:		
Fee / Fuel:		
Other Chrg: No		

Today Tons:	445.67	Loads:
Tons To Date:	5,530.64	17
Today Tonnes	404.30	
Tonnes To Date:	5,017.31	

Carrier : 854015 S CUMMINS LLC

Vehicle: CUM17 Steve

License: AT979F

MaxGVW: 80,000

Received:

Weighmaster: Colleen LeSage

Cust: _____

By acceptance of this ticket (with or without signature), driver accepts on behalf of themselves/their employer sole responsibility to ensure that the load received is within the weight limit authorized by law and shall hold seller harmless against any and all claims with respect to same CURB DELIVERY ONLY. NOT RESPONSIBLE FOR ANY DAMAGE BEYOND CURB.

P/D Status: Deliver

Customer Copy

Scale: 1



Plant: 32411

Berlin

368 New Brooklyn Road
Berlin, NJ 08009
856-809-0142

3/17/2017 11:52

In :

Customer: 8638404 THE AMBIENT GROUP LLC

Order : 950949 Camden, NJ. ABC Barrel Project

P.O. :

Tkt. No. 1006027499

Product 114203

Bank Run

S.O. Info: Camden, NJ.

Ship Ref: 327 N. Front St



	Pounds	Kilo
Gross	78,500	35,607
Tare	24,520 *	11,122
Net	53,980	24,485

26.99 Ton 24.48

* Predetermined Tare

	UNIT	TOTALS
Material:		
Freight:		
Tax:		
Fee / Fuel:		
Other Chrg: No		

Today Tons:	472.66	Loads:
Tons To Date:	5,557.63	18
Today Tonnes	428.79	
Tonnes To Date:	5,041.80	

Carrier : 2347024 JOHN MAYVILLE

Vehicle: MI488 John Mayville

License: AF420W

MaxGVW: 80,000

Received: _____

Weighmaster: Colleen LeSage

Cust: _____

By acceptance of this ticket (with or without signature), driver accepts on behalf of themselves/their employer sole responsibility to ensure that the load received is within the weight limit authorized by law and shall hold seller harmless against any and all claims with respect to same CURB DELIVERY ONLY. NOT RESPONSIBLE FOR ANY DAMAGE BEYOND CURB.

P/D Status: Deliver

Customer Copy

Scale: 1



Plant: 32411

Berlin

368 New Brooklyn Road
Berlin, NJ 08009
856-809-0142

3/17/2017 11:57

In :

Customer: 8638404 THE AMBIENT GROUP LLC

Order : 950949 Camden, NJ. ABC Barrel Project

P.O. :

Tkt. No. 1006027500

Product 114203

Bank Run

S.O. Info: Camden, NJ.

Ship Ref: 327 N. Front St



	Pounds	Kilo
Gross	77,600	35,199
Tare	27,620 *	12,528
Net	49,980	22,671

24.99 Ton 22.67

* Predetermined Tare

Today Tons:	497.65	Loads:
Tons To Date:	5,582.62	19
Today Tonnes	451.46	
Tonnes To Date:	5,064.47	

	UNIT	TOTALS
Material:		
Freight:		
Tax:		
Fee / Fuel:		
Other Chrg:	No	

Carrier : 3804135 MOD HAULING SERVICES

Vehicle: MOD105 MOD Hauling Services

License: AT496J

MaxGVW: 80,000

Received: MSD

Cust: _____

Weighmaster: Colleen LeSage

P/D Status: Deliver

Customer Copy

Scale: 1

By acceptance of this ticket (with or without signature), driver accepts on behalf of themselves/their employer sole responsibility to ensure that the load received is within the weight limit authorized by law and shall hold seller harmless against any and all claims with respect to same CURB DELIVERY ONLY. NOT RESPONSIBLE FOR ANY DAMAGE BEYOND CURB.



Plant: 32411

Berlin

368 New Brooklyn Road
Berlin, NJ 08009
856-809-0142

3/17/2017 12:15

In :

Customer: 8638404 THE AMBIENT GROUP LLC

Order : 950949 Camden, NJ. ABC Barrel Project

P.O. :

Tkt. No. 1006027502

Product 114203

Bank Run

S.O. Info: Camden, NJ.

Ship Ref: 327 N. Front St



	Pounds	Kilo
Gross	79,040	35,852
Tare	26,160 *	11,866
Net	52,880	23,986

26.44 Ton 23.99

* Predetermined Tare

Today Tons:	524.09	Loads:
Tons To Date:	5,609.06	20
Today Tonnes	475.45	
Tonnes To Date:	5,088.45	

	UNIT	TOTALS
Material:		
Freight:		
Tax:		
Fee / Fuel:		
Other Chrg:	No	

Carrier : 2347809 ROBBINS & SONS HAULING IN

Vehicle: RY093 AS527V

License: AS527V

MaxGVW: 80,000

Received: _____

Cust: _____

Weighmaster: Colleen LeSage

P/D Status: Deliver

Customer Do Not Accept [2]

Scale: 1

By acceptance of this ticket (with or without signature), driver accepts on behalf of themselves/their employer sole responsibility to ensure that the load received is within the weight limit authorized by law and shall hold seller harmless against any and all claims with respect to same CURB DELIVERY ONLY. NOT RESPONSIBLE FOR ANY DAMAGE BEYOND CURB.



Plant: 32411

Berlin

368 New Brooklyn Road
Berlin, NJ 08009
856-809-0142

3/17/2017 13:00

In :

Customer: 8638404 THE AMBIENT GROUP LLC

Order : 950949 Camden, NJ. ABC Barrel Project

P.O. :

Tkt. No. 1006027505

Product 114203



Bank Run

S.O. Info: Camden, NJ.

Ship Ref: 327 N. Front St

	Pounds	Kilo
Gross	77,860	35,317
Tare	27,160 *	12,320
Net	50,700	22,997

25.35 Ton 23.00

* Predetermined Tare

UNIT	TOTALS
Material:	
Freight:	
Tax:	
Fee / Fuel:	
Other Chrg: No	

Today Tons:	549.44	Loads:
Tons To Date:	5,634.41	21
Today Tonnes	498.44	
Tonnes To Date:	5,111.45	

Carrier : 2347631 R A DIMARIA

Vehicle: DY026 DiMaria

License: AS200U

MaxGVW: 80,000

Received:

Weighmaster: Colleen LeSage

Cust: _____

P/D Status: Deliver

Customer Do Not Accept [1] Scale: 1

By acceptance of this ticket (with or without signature), driver accepts on behalf of themselves/their employer sole responsibility to ensure that the load received is within the weight limit authorized by law and shall hold seller harmless against any and all claims with respect to same CURB DELIVERY ONLY .NOT RESPONSIBLE FOR ANY DAMAGE BEYOND CURB.



Plant: 32411

Berlin

368 New Brooklyn Road
Berlin, NJ 08009
856-809-0142

3/17/2017 13:04

In :

Customer: 8638404 THE AMBIENT GROUP LLC

Order : 950949 Camden, NJ. ABC Barrel Project

P.O. :

Tkt. No. 1006027506

Product 114203



Bank Run

S.O. Info: Camden, NJ.

Ship Ref: 327 N. Front St

	Pounds	Kilo
Gross	78,080	35,416
Tare	26,540 *	12,038
Net	51,540	23,378

25.77 Ton 23.38

* Predetermined Tare

UNIT	TOTALS
Material:	
Freight:	
Tax:	
Fee / Fuel:	
Other Chrg: No	

Today Tons:	575.21	Loads:
Tons To Date:	5,660.18	22
Today Tonnes	521.82	
Tonnes To Date:	5,134.83	

Carrier : 2347032 ROCKY LOGIOVINO TRUCKIN

Vehicle: LR060 Rocky

License: AM637B

MaxGVW: 80,000

Received: _____

Weighmaster: Colleen LeSage

Cust: _____

P/D Status: Deliver

Customer Do Not Accept [2] Scale: 1

By acceptance of this ticket (with or without signature), driver accepts on behalf of themselves/their employer sole responsibility to ensure that the load received is within the weight limit authorized by law and shall hold seller harmless against any and all claims with respect to same CURB DELIVERY ONLY .NOT RESPONSIBLE FOR ANY DAMAGE BEYOND CURB.



Plant: 32411

Berlin
368 New Brooklyn Road
Berlin, NJ 08009
856-809-0142, -

3/17/2017 13:06 In :
Customer: 8638404 THE AMBIENT GROUP LLC
Order : 950949 Camden, NJ. ABC Barrel Project
P.O. :

Tkt. No. 1006027507

Product 114203
Bank Run
S.O. Info: Camden, NJ.
Ship Ref: 327 N. Front St



	Pounds	Kilo
Gross	78,740	35,716
Tare	24,960 *	11,322
Net	53,780	24,394

26.89 Ton 24.39
* Predetermined Tare

	UNIT	TOTALS
Material:		
Freight:		
Tax:		
Fee / Fuel:		
Other Chrg: No		

Today Tons:	602.10	Loads:
Tons To Date:	5,687.07	23
Today Tonnes	546.22	
Tonnes To Date:	5,159.22	

Carrier : 8540415 S CUMMINS LLC
Vehicle: CUM17 Steve
License: AT979F
MaxGVW: 80,000

By acceptance of this ticket (with or without signature), driver accepts on behalf of themselves/their employer sole responsibility to ensure that the load received is within the weight limit authorized by law and shall hold seller harmless against any and all claims with respect to same CURB DELIVERY ONLY. NOT RESPONSIBLE FOR ANY DAMAGE BEYOND CURB.

Received: _____
Weighmaster: Colleen LeSage

Cust: _____

P/D Status: Deliver

Customer Do Not Accept [2] Scale: 1



Plant: 32411

Berlin
368 New Brooklyn Road
Berlin, NJ 08009
856-809-0142.

3/17/2017 13:23 In :
Customer: 8638404 THE AMBIENT GROUP LLC
Order : 950949 Camden, NJ. ABC Barrel Project
P.O. :

Tkt. No. 1006027509

Product 114203
Bank Run
S.O. Info: Camden, NJ.
Ship Ref: 327 N. Front St



	Pounds	Kilo
Gross	79,520	36,070
Tare	24,520 *	11,122
Net	55,000	24,948

27.50 Ton 24.95
* Predetermined Tare

	UNIT	TOTALS
Material:		
Freight:		
Tax:		
Fee / Fuel:		
Other Chrg: No		

Today Tons:	629.60	Loads:
Tons To Date:	5,714.57	24
Today Tonnes	571.16	
Tonnes To Date:	5,184.17	

Carrier : 2347024 JOHN MAYVILLE
Vehicle: MI488 John Mayville
License: AF420W
MaxGVW: 80,000

By acceptance of this ticket (with or without signature), driver accepts on behalf of themselves/their employer sole responsibility to ensure that the load received is within the weight limit authorized by law and shall hold seller harmless against any and all claims with respect to same CURB DELIVERY ONLY. NOT RESPONSIBLE FOR ANY DAMAGE BEYOND CURB.

Received: _____
Weighmaster: Colleen LeSage

Cust: _____

P/D Status: Deliver

Customer Copy Scale: 1



Plant: 32411

Berlin

368 New Brooklyn Road
Berlin, NJ 08009
856-809-0142

3/20/2017 07:34

In: 6:26:32

Customer: 8638404

THE AMBIENT GROUP LLC

Order: 950949

Camden, NJ. ABC Barrel Project

P.O.:

Tkt. No.

1006027517

Product 114203

Bank Run

S.O. Info: Camden, NJ.

Ship Ref: 327 N. Front St



	Pounds	Kilo
Gross	79,320	35,979
Tare	26,240	11,902
Net	53,080	24,077
	26.54 Ton	24.08

UNIT	TOTALS
Material:	
Freight:	
Tax:	
Fee / Fuel:	
Other Chrg: <u>No</u>	

Today Tons:	26.54	Loads:
Tons To Date:	5,741.11	1
Today Tonnes	24.08	
Tonnes To Date:	5,208.25	

By acceptance of this ticket (with or without signature), driver accepts on behalf of themselves/their employer sole responsibility to ensure that the load received is within the weight limit authorized by law and shall hold seller harmless against any and all claims with respect to same
CURB DELIVERY ONLY. NOT RESPONSIBLE FOR ANY DAMAGE BEYOND CURB.

Carrier: 2347243 A P SIMIONE

Vehicle: SA194

Simione

License: AB423G

MaxGVW: 80,000

Received: _____

Cust: _____

Weighmaster: Colleen LeSage

P/D Status: Deliver

Customer Do Not Accept [2] Scale: 1



Plant: 32411

Berlin

368 New Brooklyn Road
Berlin, NJ 08009
856-809-0142

3/20/2017 07:39

In: 5:57:45

Customer: 8638404

THE AMBIENT GROUP LLC

Order: 950949

Camden, NJ. ABC Barrel Project

P.O.:

Tkt. No.

1006027518

Product 114203

Bank Run

S.O. Info: Camden, NJ.

Ship Ref: 327 N. Front St



	Pounds	Kilo
Gross	76,140	34,537
Tare	24,660	11,186
Net	51,480	23,351
	25.74 Ton	23.35

UNIT	TOTALS
Material:	
Freight:	
Tax:	
Fee / Fuel:	
Other Chrg: <u>No</u>	

Today Tons:	52.28	Loads:
Tons To Date:	5,766.85	2
Today Tonnes	47.43	
Tonnes To Date:	5,231.60	

By acceptance of this ticket (with or without signature), driver accepts on behalf of themselves/their employer sole responsibility to ensure that the load received is within the weight limit authorized by law and shall hold seller harmless against any and all claims with respect to same
CURB DELIVERY ONLY. NOT RESPONSIBLE FOR ANY DAMAGE BEYOND CURB.

Carrier: 2346970 GEORGE LAZOS TRUCKING

Vehicle: LG004

AP213T

License: LG004

MaxGVW: 80,000

Received: _____

Cust: _____

Weighmaster: Colleen LeSage

P/D Status: Deliver

Customer Copy Scale: 1



Plant: 32411

Berlin

368 New Brooklyn Road
Berlin, NJ 08009
856-809-0142

3/20/2017 07:41 In: 6:27:35
Customer: 8638404 THE AMBIENT GROUP LLC
Order: 950949 Camden, NJ. ABC Barrel Project
P.O.:

Tkt. No. 1006027519

Product 114203
Bank Run
S.O. Info: Camden, NJ.
Ship Ref: 327 N. Front St



	Pounds	Kilo
Gross	79,300	35,970
Tare	27,680	12,555
Net	51,620	23,414
	25.81 Ton	23.41

	UNIT	TOTALS
Material:		
Freight:		
Tax:		
Fee / Fuel:		
Other Chrg: No		

Today Tons:	78.09	Loads:
Tons To Date:	5,792.66	3
Today Tonnes	70.84	
Tonnes To Date:	5,255.01	

Carrier : 3804135 MOD HAULING SERVICES
Vehicle: MOD105 MOD Hauling Services
License: AT496J
MaxGVW: 80,000

By acceptance of this ticket (with or without signature), driver accepts on behalf of themselves/their employer sole responsibility to ensure that the load received is within the weight limit authorized by law and shall holdseller harmless against any and all claims with respect to same CURB DELIVERY ONLY. NOT RESPONSIBLE FOR ANY DAMAGE BEYOND CURB.

Received: MSD
Weighmaster: Colleen LeSage

Cust: _____

P/D Status: Deliver

Customer Copy Scale: 1



Plant: 32411

Berlin

368 New Brooklyn Road
Berlin, NJ 08009
856-809-0142

3/20/2017 07:42 In: 6:27:19
Customer: 8638404 THE AMBIENT GROUP LLC
Order: 950949 Camden, NJ. ABC Barrel Project
P.O.:

Tkt. No. 1006027520

Product 114203
Bank Run
S.O. Info: Camden, NJ.
Ship Ref: 327 N. Front St



	Pounds	Kilo
Gross	78,360	35,543
Tare	26,100	11,839
Net	52,260	23,705
	26.13 Ton	23.70

	UNIT	TOTALS
Material:		
Freight:		
Tax:		
Fee / Fuel:		
Other Chrg: No		

Today Tons:	104.22	Loads:
Tons To Date:	5,818.79	4
Today Tonnes	94.55	
Tonnes To Date:	5,278.72	

Carrier : 2347809 ROBBINS & SONS HAULING IN
Vehicle: RY093 AS527V
License: AS527V
MaxGVW: 80,000

By acceptance of this ticket (with or without signature), driver accepts on behalf of themselves/their employer sole responsibility to ensure that the load received is within the weight limit authorized by law and shall holdseller harmless against any and all claims with respect to same CURB DELIVERY ONLY. NOT RESPONSIBLE FOR ANY DAMAGE BEYOND CURB.

Received: _____
Weighmaster: Colleen LeSage

Cust: _____

P/D Status: Deliver

Customer Copy Scale: 1



Plant: 32411

Berlin

368 New Brooklyn Road
Berlin, NJ 08009
856-809-0142

3/20/2017 07:46

In: 7:08:28

Customer: 8638404

THE AMBIENT GROUP LLC

Order: 950949

Camden, NJ. ABC Barrel Project

P.O.:

Tkt. No. 1006027521



Product 114203

Bank Run

S.O. Info: Camden, NJ.

Ship Ref: 327 N. Front St

	Pounds	Kilo
Gross	77,700	35,244
Tare	27,140	12,310
Net	50,560	22,934

25.28 Ton 22.93

UNIT	TOTALS
Material:	
Freight:	
Tax:	
Fee / Fuel:	
Other Chrg: <u>No</u>	

Today Tons:	129.50	Loads:
Tons To Date:	5,844.07	5
Today Tonnes	117.48	
Tonnes To Date:	5,301.65	

By acceptance of this ticket (with or without signature), driver accepts on behalf of themselves/their employer sole responsibility to ensure that the load received is within the weight limit authorized by law and shall hold seller harmless against any and all claims with respect to same CURB DELIVERY ONLY. NOT RESPONSIBLE FOR ANY DAMAGE BEYOND CURB.

Carrier: 2347631 R A DIMARIA

Vehicle: DY026

DiMaria

License: AS200U

MaxGVW: 80,000

Received:

Weighmaster: Colleen LeSage

Cust: _____

P/D Status: Deliver

Customer Copy

Scale: 1



Plant: 32411

Berlin

368 New Brooklyn Road
Berlin, NJ 08009
856-809-0142

3/20/2017 07:48

In: 6:27:02

Customer: 8638404

THE AMBIENT GROUP LLC

Order: 950949

Camden, NJ. ABC Barrel Project

P.O.:

Tkt. No. 1006027522



Product 114203

Bank Run

S.O. Info: Camden, NJ.

Ship Ref: 327 N. Front St

	Pounds	Kilo
Gross	78,860	35,770
Tare	26,420	11,984
Net	52,440	23,786

26.22 Ton 23.79

UNIT	TOTALS
Material:	
Freight:	
Tax:	
Fee / Fuel:	
Other Chrg: <u>No</u>	

Today Tons:	155.72	Loads:
Tons To Date:	5,870.29	6
Today Tonnes	141.27	
Tonnes To Date:	5,325.44	

By acceptance of this ticket (with or without signature), driver accepts on behalf of themselves/their employer sole responsibility to ensure that the load received is within the weight limit authorized by law and shall hold seller harmless against any and all claims with respect to same CURB DELIVERY ONLY. NOT RESPONSIBLE FOR ANY DAMAGE BEYOND CURB.

Carrier: 2346970 GEORGE LAZOS TRUCKING

Vehicle: LG003

AS512W

License: AS512W

MaxGVW: 80,000

Received: _____

Weighmaster: Colleen LeSage

Cust: _____

P/D Status: Deliver

Customer Do Not Accept [3]

Scale: 1



Plant: 32411

Berlin

368 New Brooklyn Road
Berlin, NJ 08009
856-809-0142

3/20/2017 07:55

In: 6:27:25

Customer: 8638404

THE AMBIENT GROUP LLC

Order: 950949

Camden, NJ. ABC Barrel Project

Tkt. No.

1006027523

P.O.:

Product 114203

Bank Run

S.O. Info: Camden, NJ.

Ship Ref: 327 N. Front St



	Pounds	Kilo
Gross	78,060	35,407
Tare	24,600	11,158
Net	53,460	24,249

26.73 Ton 24.25

	UNIT	TOTALS
Material:		
Freight:		
Tax:		
Fee / Fuel:		
Other Chrg: No		

Today Tons:	182.45	Loads:
Tons To Date:	5,897.02	7
Today Tonnes	165.52	
Tonnes To Date:	5,349.69	

Carrier : 2347024 JOHN MAYVILLE

Vehicle: MI488

John Mayville

License: AF420W

MaxGVW: 80,000

Received:

Cust:

Weighmaster: Colleen LeSage

P/D Status: Deliver

By acceptance of this ticket (with or without signature), driver accepts on behalf of themselves/their employer sole responsibility to ensure that the load received is within the weight limit authorized by law and shall hold seller harmless against any and all claims with respect to same
CURB DELIVERY ONLY. NOT RESPONSIBLE FOR ANY DAMAGE BEYOND CURB.

Customer Do Not Accept [1]

Scale: 1



Plant: 32411

Berlin

368 New Brooklyn Road
Berlin, NJ 08009
856-809-0142

3/20/2017 09:04

In: 8:45:44

Customer: 8638404

THE AMBIENT GROUP LLC

Order: 950949

Camden, NJ. ABC Barrel Project

Tkt. No.

1006027530

P.O.:

Product 114203

Bank Run

S.O. Info: Camden, NJ.

Ship Ref: 327 N. Front St

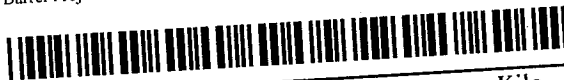

	Pounds	Kilo
Gross	76,340	34,627
Tare	23,340	10,587
Net	53,000	24,040

26.50 Ton 24.04

	UNIT	TOTALS
Material:		
Freight:		
Tax:		
Fee / Fuel:		
Other Chrg: No		

Today Tons:	208.95	Loads:
Tons To Date:	5,923.52	8
Today Tonnes	189.56	
Tonnes To Date:	5,373.73	

Carrier : 8515471 CALLE TRUCKING LLC

Vehicle: CALLE9

AG07469

License: AG07469

MaxGVW: 80,000

Received:

Cust:

Weighmaster: Colleen LeSage

P/D Status: Deliver

By acceptance of this ticket (with or without signature), driver accepts on behalf of themselves/their employer sole responsibility to ensure that the load received is within the weight limit authorized by law and shall hold seller harmless against any and all claims with respect to same
CURB DELIVERY ONLY. NOT RESPONSIBLE FOR ANY DAMAGE BEYOND CURB.

Customer Copy

Scale: 1



Plant: 32411

Berlin
368 New Brooklyn Road
Berlin, NJ 08009
856-809-0142

3/20/2017 09:08 In :
Customer: 8638404 THE AMBIENT GROUP LLC
Order : 950949 Camden, NJ. ABC Barrel Project
P.O. :

Tkt. No. 1006027531



Product 114203
Bank Run
S.O. Info: Camden, NJ.
Ship Ref: 327 N. Front St

	Pounds	Kilo
Gross	78,780	35,734
Tare	26,240 *	11,902
Net	52,540	23,832
	26.27 Ton	23.83

* Predetermined Tare

	UNIT	TOTALS
Material:		
Freight:		
Tax:		
Fee / Fuel:		
Other Chrg: No		

Today Tons:	235.22	Loads:
Tons To Date:	5,949.79	9
Today Tonnes	213.39	
Tonnes To Date:	5,397.56	

By acceptance of this ticket (with or without signature), driver accepts on behalf of themselves/their employer sole responsibility to ensure that the load received is within the weight limit authorized by law and shall hold seller harmless against any and all claims with respect to same
CURB DELIVERY ONLY. NOT RESPONSIBLE FOR ANY DAMAGE BEYOND CURB.

Carrier : 2347243 A P SIMIONE
Vehicle: SA194 Simione
License: AB423G
MaxGVW: 80,000
Received: _____

Cust: _____

Weighmaster: Colleen LeSage
P/D Status: Deliver

Customer Do Not Accept [2] Scale: 1



Plant: 32411

Berlin
368 New Brooklyn Road
Berlin, NJ 08009
856-809-0142

3/20/2017 09:11 In :
Customer: 8638404 THE AMBIENT GROUP LLC
Order : 950949 Camden, NJ. ABC Barrel Project
P.O. :

Tkt. No. 1006027532

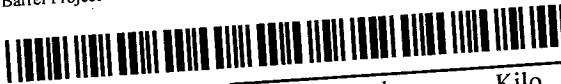

Product 114203
Bank Run
S.O. Info: Camden, NJ.
Ship Ref: 327 N. Front St

	Pounds	Kilo
Gross	78,420	35,571
Tare	27,680 *	12,555
Net	50,740	23,015
	25.37 Ton	23.02

* Predetermined Tare

	UNIT	TOTALS
Material:		
Freight:		
Tax:		
Fee / Fuel:		
Other Chrg: No		

Today Tons:	260.59	Loads:
Tons To Date:	5,975.16	10
Today Tonnes	236.40	
Tonnes To Date:	5,420.57	

By acceptance of this ticket (with or without signature), driver accepts on behalf of themselves/their employer sole responsibility to ensure that the load received is within the weight limit authorized by law and shall hold seller harmless against any and all claims with respect to same
CURB DELIVERY ONLY. NOT RESPONSIBLE FOR ANY DAMAGE BEYOND CURB.

Carrier : 3804135 MOD HAULING SERVICES
Vehicle: MOD105 MOD Hauling Services
License: AT496J
MaxGVW: 80,000
Received: _____
Weighmaster: Colleen LeSage
P/D Status: Deliver

Cust: _____

Customer Do Not Accept [2] Scale: 1



Plant: 32411

Berlin

368 New Brooklyn Road
Berlin, NJ 08009
856-809-0142

3/20/2017 09:14 In:
Customer: 8638404 THE AMBIENT GROUP LLC
Order: 950949 Camden, NJ. ABC Barrel Project
P.O.:

Tkt. No. 1006027533

Product 114203
Bank Run
S.O. Info: Camden, NJ
Ship Ref: 327 N. Front St



	Pounds	Kilo
Gross	76,540	34,718
Tare	24,660 *	11,186
Net	51,880	23,532

25.94 Ton 23.53
* Predetermined Tare

	UNIT	TOTALS
Material:		
Freight:		
Tax:		
Fee / Fuel:		
Other Chrg: No		

Today Tons:	286.53	Loads:
Tons To Date:	6,001.10	11
Today Tonnes	259.94	
Tonnes To Date:	5,444.11	

Carrier: 2346970 GEORGE LAZOS TRUCKING
Vehicle: LG004 AP213T
License: LG004
MaxGVW: 80,000

By acceptance of this ticket (with or without signature), driver accepts on behalf of themselves/their employer sole responsibility to ensure that the load received is within the weight limit authorized by law and shall hold seller harmless against any and all claims with respect to same CURB DELIVERY ONLY. NOT RESPONSIBLE FOR ANY DAMAGE BEYOND CURB.

Received: _____
Weighmaster: Colleen LeSage

Cust: _____

P/D Status: Deliver

Customer Copy

Scale: 1



Plant: 32411

368 New Brooklyn Road
Berlin, NJ 08009
856-809-0142

3/20/2017 09:18 In:
Customer: 8638404 THE AMBIENT GROUP LLC
Order: 950949 Camden, NJ. ABC Barrel Project
P.O.:

Tkt. No. 1006027534

Product 114203
Bank Run
S.O. Info: Camden, NJ
Ship Ref: 327 N. Front St



	Pounds	Kilo
Gross	77,840	35,308
Tare	26,100 *	11,839
Net	51,740	23,469

25.87 Ton 23.47
* Predetermined Tare

	UNIT	TOTALS
Material:		
Freight:		
Tax:		
Fee / Fuel:		
Other Chrg: No		

Today Tons:	312.40	Loads:
Tons To Date:	6,026.97	12
Today Tonnes	283.40	
Tonnes To Date:	5,467.58	

By acceptance of this ticket (with or without signature), driver accepts on behalf of themselves/their employer sole responsibility to ensure that the load received is within the weight limit authorized by law and shall hold seller harmless against any and all claims with respect to same CURB DELIVERY ONLY. NOT RESPONSIBLE FOR ANY DAMAGE BEYOND CURB.

Carrier: 2347809 ROBBINS & SONS HAULING IN
Vehicle: RY093 AS527V
License: AS527V
MaxGVW: 80,000

Received: _____
Weighmaster: Colleen LeSage

Cust: _____

P/D Status: Deliver

Customer Do Not Accept [2]

Scale: 1



Plant: 32411

Berlin

368 New Brooklyn Road
Berlin, NJ 08009
856-809-0142

3/20/2017 09:26

In :

Customer: 8638404 THE AMBIENT GROUP LLC

Order : 950949 Camden, NJ. ABC Barrel Project

P.O. :

Tkt. No. 1006027535

Product 114203

Bank Run

S.O. Info: Camden, NJ.

Ship Ref: 327 N. Front St



	Pounds	Kilo
Gross	77,360	35,090
Tare	27,140 *	12,310
Net	50,220	22,779

25.11 Ton 22.78

* Predetermined Tare

	UNIT	TOTALS
Material:		
Freight:		
Tax:		
Fee / Fuel:		
Other Chrg: No		

Today Tons:	337.51	Loads:
Tons To Date:	6,052.08	13
Today Tonnes	306.18	
Tonnes To Date:	5,490.35	

Carrier : 2347631 R A DIMARIA

Vehicle: DY026 DiMaria

License: AS200U

MaxGVW: 80,000

Received: _____

Weighmaster: Colleen LeSage

By acceptance of this ticket (with or without signature), driver accepts on behalf of themselves/their employer sole responsibility to ensure that the load received is within the weight limit authorized by law and shall hold seller harmless against any and all claims with respect to same CURB DELIVERY ONLY. NOT RESPONSIBLE FOR ANY DAMAGE BEYOND CURB.

Cust: _____

P/D Status: Deliver

Customer Copy

Scale: 1



Plant: 32411

Berlin

368 New Brooklyn Road
Berlin, NJ 08009
856-809-0142

3/20/2017 09:29

In :

Customer: 8638404 THE AMBIENT GROUP LLC

Order : 950949 Camden, NJ. ABC Barrel Project

P.O. :

Tkt. No. 1006027536

Product 114203

Bank Run

S.O. Info: Camden, NJ.

Ship Ref: 327 N. Front St



	Pounds	Kilo
Gross	77,640	35,217
Tare	24,600 *	11,158
Net	53,040	24,059

26.52 Ton 24.06

* Predetermined Tare

	UNIT	TOTALS
Material:		
Freight:		
Tax:		
Fee / Fuel:		
Other Chrg: No		

Today Tons:	364.03	Loads:
Tons To Date:	6,078.60	14
Today Tonnes	330.24	
Tonnes To Date:	5,514.41	

By acceptance of this ticket (with or without signature), driver accepts on behalf of themselves/their employer sole responsibility to ensure that the load received is within the weight limit authorized by law and shall hold seller harmless against any and all claims with respect to same CURB DELIVERY ONLY. NOT RESPONSIBLE FOR ANY DAMAGE BEYOND CURB.

Cust: _____

Carrier : 2347024 JOHN MAYVILLE

Vehicle: MI488 John Mayville

License: AF420W

MaxGVW: 80,000

Received: _____

Weighmaster: Colleen LeSage

P/D Status: Deliver

Customer Do Not Accept [3]

Scale: 1



Plant: 32411

Berlin
368 New Brooklyn Road
Berlin, NJ 08009
856-809-0142

3/20/2017 09:48 In :
Customer: 8638404 THE AMBIENT GROUP LLC
Order : 950949 Camden, NJ. ABC Barrel Project
P.O. :

Tkt. No. 1006027539

Product 114203
Bank Run
S.O. Info: Camden, NJ.
Ship Ref: 327 N. Front St



	Pounds	Kilo
Gross	79,040	35,852
Tare	26,420 *	11,984
Net	52,620	23,868

26.31 Ton 23.87

* Predetermined Tare

	UNIT	TOTALS
Material:		
Freight:		
Tax:		
Fee / Fuel:		
Other Chrg: No		

Today Tons:	390.34	Loads:
Tons To Date:	6,104.91	15
Today Tonnes	354.11	
Tonnes To Date:	5,538.28	

Carrier : 2346970 GEORGE LAZOS TRUCKING
Vehicle: LG003 AS512W
License: AS512W
MaxGVW: 80,000

By acceptance of this ticket (with or without signature), driver accepts on behalf of themselves/their employer sole responsibility to ensure that the load received is within the weight limit authorized by law and shall hold seller harmless against any and all claims with respect to same CURB DELIVERY ONLY. NOT RESPONSIBLE FOR ANY DAMAGE BEYOND CURB.

Received: _____
Weighmaster: Colleen LeSage

Cust: _____

P/D Status: Deliver

Customer Do Not Accept [2] Scale: 1



Plant: 32411

Berlin
368 New Brooklyn Road
Berlin, NJ 08009
856-809-0142

3/20/2017 10:26 In : 10:07:50
Customer: 8638404 THE AMBIENT GROUP LLC
Order : 950949 Camden, NJ. ABC Barrel Project
P.O. :

Tkt. No. 1006027541

Product 114203
Bank Run
S.O. Info: Camden, NJ.
Ship Ref: 327 N. Front St



	Pounds	Kilo
Gross	78,420	35,571
Tare	27,860	12,637
Net	50,560	22,934

25.28 Ton 22.93

	UNIT	TOTALS
Material:		
Freight:		
Tax:		
Fee / Fuel:		
Other Chrg: No		

Today Tons:	415.62	Loads:
Tons To Date:	6,130.19	16
Today Tonnes	377.04	
Tonnes To Date:	5,561.21	

Carrier : 9249110 CLM CONTRACTING LLC
Vehicle: CLM6 CLM6
License: AT597T
MaxGVW: 80,000

By acceptance of this ticket (with or without signature), driver accepts on behalf of themselves/their employer sole responsibility to ensure that the load received is within the weight limit authorized by law and shall hold seller harmless against any and all claims with respect to same CURB DELIVERY ONLY. NOT RESPONSIBLE FOR ANY DAMAGE BEYOND CURB.

Received: _____
Weighmaster: Colleen LeSage

Cust: _____

P/D Status: Deliver

Customer Do Not Accept [2] Scale: 1



Plant: 32411

Berlin

368 New Brooklyn Road
Berlin, NJ 08009
856-809-0142

3/20/2017 10:31 In :
Customer: 8638404 THE AMBIENT GROUP LLC
Order : 950949 Camden, NJ. ABC Barrel Project
P.O. :

Tkt. No. 1006027542

Product 114203
Bank Run
S.O. Info: Camden, NJ.
Ship Ref: 327 N. Front St



	Pounds	Kilo
Gross	79,800	36,197
Tare	26,240 *	11,902
Net	53,560	24,294

26.78 Ton 24.29
* Predetermined Tare

	UNIT	TOTALS
Material:		
Freight:		
Tax:		
Fee / Fuel:		
Other Chrg: No		

Today Tons:	442.40	Loads:
Tons To Date:	6,156.97	17
Today Tonnes	401.34	
Tonnes To Date:	5,585.51	

Carrier : 2347243 A P SIMIONE
Vehicle: SA194 Simione
License: AB423G
MaxGVW: 80,000

By acceptance of this ticket (with or without signature), driver accepts on behalf of themselves/their employer sole responsibility to ensure that the load received is within the weight limit authorized by law and shall hold seller harmless against any and all claims with respect to same CURB DELIVERY ONLY. NOT RESPONSIBLE FOR ANY DAMAGE BEYOND CURB.

Received: _____
Weighmaster: Colleen LeSage

Cust: _____

P/D Status: Deliver

Customer Copy

Scale: 1



Plant: 32411

Berlin

368 New Brooklyn Road
Berlin, NJ 08009
856-809-0142

3/20/2017 10:34 In :
Customer: 8638404 THE AMBIENT GROUP LLC
Order : 950949 Camden, NJ. ABC Barrel Project
P.O. :

Tkt. No. 1006027543

Product 114203
Bank Run
S.O. Info: Camden, NJ.
Ship Ref: 327 N. Front St



	Pounds	Kilo
Gross	75,820	34,391
Tare	23,340 *	10,587
Net	52,480	23,805

26.24 Ton 23.80
* Predetermined Tare

	UNIT	TOTALS
Material:		
Freight:		
Tax:		
Fee / Fuel:		
Other Chrg: No		

Today Tons:	468.64	Loads:
Tons To Date:	6,183.21	18
Today Tonnes	425.14	
Tonnes To Date:	5,609.31	

Carrier : 8515471 CALLE TRUCKING LLC
Vehicle: CALLE9 AG07469
License: AG07469
MaxGVW: 80,000

By acceptance of this ticket (with or without signature), driver accepts on behalf of themselves/their employer sole responsibility to ensure that the load received is within the weight limit authorized by law and shall hold seller harmless against any and all claims with respect to same CURB DELIVERY ONLY. NOT RESPONSIBLE FOR ANY DAMAGE BEYOND CURB.

Received: Patricia LeSage
Weighmaster: Colleen LeSage

Cust: _____

P/D Status: Deliver

Customer Do Not Accept [2]

Scale: 1



Plant: 32411

Berlin

368 New Brooklyn Road
Berlin, NJ 08009
856-809-0142

3/20/2017 10:36

In:

Customer: 8638404 THE AMBIENT GROUP LLC

Order: 950949 Camden, NJ. ABC Barrel Project

P.O.:

Tkt. No. 1006027544

Product 114203

Bank Run

S.O. Info: Camden, NJ.

Ship Ref: 327 N. Front St



	Pounds	Kilo
Gross	78,880	35,779
Tare	27,680 *	12,555
Net	51,200	23,224

25.60 Ton 23.22

* Predetermined Tare

Today Tons:	494.24	Loads:
Tons To Date:	6,208.81	19
Today Tonnes	448.37	
Tonnes To Date:	5,632.54	

	UNIT	TOTALS
Material:		
Freight:		
Tax:		
Fee / Fuel:		
Other Chrg:	No	

Carrier: 3804135 MOD HAULING SERVICES

Vehicle: MOD105 MOD Hauling Services

License: AT496J

MaxGVW: 80,000

Received: [Signature]

Cust: _____

Weighmaster: Colleen LeSage

P/D Status: Deliver

Customer Copy

Scale: 1

By acceptance of this ticket (with or without signature), driver accepts on behalf of themselves/their employer sole responsibility to ensure that the load received is within the weight limit authorized by law and shall hold seller harmless against any and all claims with respect to same CURB DELIVERY ONLY. NOT RESPONSIBLE FOR ANY DAMAGE BEYOND CURB.



Plant: 32411

Berlin

368 New Brooklyn Road
Berlin, NJ 08009
856-809-0142

3/20/2017 10:40

In:

Customer: 8638404 THE AMBIENT GROUP LLC

Order: 950949 Camden, NJ. ABC Barrel Project

P.O.:

Tkt. No. 1006027546

Product 114203

Bank Run

S.O. Info: Camden, NJ.

Ship Ref: 327 N. Front St



	Pounds	Kilo
Gross	77,400	35,108
Tare	24,660 *	11,186
Net	52,740	23,922

26.37 Ton 23.92

* Predetermined Tare

Today Tons:	520.61	Loads:
Tons To Date:	6,235.18	20
Today Tonnes	472.29	
Tonnes To Date:	5,656.46	

	UNIT	TOTALS
Material:		
Freight:		
Tax:		
Fee / Fuel:		
Other Chrg:	No	

Carrier: 2346970 GEORGE LAZOS TRUCKING

Vehicle: LG004 AP213T

License: LG004

MaxGVW: 80,000

Received: _____

Cust: _____

Weighmaster: Colleen LeSage

P/D Status: Deliver

Customer Copy

Scale: 1

By acceptance of this ticket (with or without signature), driver accepts on behalf of themselves/their employer sole responsibility to ensure that the load received is within the weight limit authorized by law and shall hold seller harmless against any and all claims with respect to same CURB DELIVERY ONLY. NOT RESPONSIBLE FOR ANY DAMAGE BEYOND CURB.



Plant: 32411

Berlin
368 New Brooklyn Road
Berlin, NJ 08009
856-809-0142

3/20/2017 10:43 In :
Customer: 8638404 THE AMBIENT GROUP LLC
Order : 950949 Camden, NJ. ABC Barrel Project
P.O. :

Tkt. No. 1006027548

Product 114203
Bank Run
S.O. Info: Camden, NJ.
Ship Ref: 327 N. Front St



	Pounds	Kilo
Gross	78,380	35,553
Tare	26,100 *	11,839
Net	52,280	23,714

26.14 Ton 23.71

* Predetermined Tare

Today Tons:	546.75	Loads:
Tons To Date:	6,261.32	21
Today Tonnes	496.00	
Tonnes To Date:	5,680.17	

By acceptance of this ticket (with or without signature), driver accepts on behalf of themselves/their employer sole responsibility to ensure that the load received is within the weight limit authorized by law and shall hold seller harmless against any and all claims with respect to same. CURB DELIVERY ONLY. NOT RESPONSIBLE FOR ANY DAMAGE BEYOND CURB.

Material:	UNIT	TOTALS
Freight:		
Tax:		
Fee / Fuel:		
Other Chrg: No		

Carrier : 2347809 ROBBINS & SONS HAULING IN
Vehicle: RY093 AS527V
License: AS527V
MaxGVW: 80,000

Received: _____ Cust: _____

Weighmaster: Colleen LeSage

P/D Status: Deliver

Customer Do Not Accept [3] Scale: 1



Plant: 32411

Berlin
368 New Brooklyn Road
Berlin, NJ 08009
856-809-0142

3/20/2017 10:50 In :
Customer: 8638404 THE AMBIENT GROUP LLC
Order : 950949 Camden, NJ. ABC Barrel Project
P.O. :

Tkt. No. 1006027552

Product 114203
Bank Run
S.O. Info: Camden, NJ.
Ship Ref: 327 N. Front St



	Pounds	Kilo
Gross	78,320	35,525
Tare	27,140 *	12,310
Net	51,180	23,215

25.59 Ton 23.21

* Predetermined Tare

Today Tons:	572.34	Loads:
Tons To Date:	6,286.91	22
Today Tonnes	519.22	
Tonnes To Date:	5,703.39	

By acceptance of this ticket (with or without signature), driver accepts on behalf of themselves/their employer sole responsibility to ensure that the load received is within the weight limit authorized by law and shall hold seller harmless against any and all claims with respect to same. CURB DELIVERY ONLY. NOT RESPONSIBLE FOR ANY DAMAGE BEYOND CURB.

Material:	UNIT	TOTALS
Freight:		
Tax:		
Fee / Fuel:		
Other Chrg: No		

Carrier : 2347631 R A DIMARIA
Vehicle: DY026 DiMaria
License: AS200U
MaxGVW: 80,000

Received: _____ Cust: _____

Weighmaster: Colleen LeSage

P/D Status: Deliver

Customer Do Not Accept [2] Scale: 1



Plant: 32411

Berlin
368 New Brooklyn Road
Berlin, NJ 08009
856-809-0142

3/20/2017 10:55 In :
Customer: 8638404 THE AMBIENT GROUP LLC
Order : 950949 Camden, NJ. ABC Barrel Project
P.O. :

Tkt. No. 1006027554



Product 114203
Bank Run
S.O. Info: Camden, NJ.
Ship Ref: 327 N. Front St

	Pounds	Kilo
Gross	78,500	35,607
Tare	24,600 *	11,158
Net	53,900	24,449

26.95 Ton 24.45
* Predetermined Tare

	UNIT	TOTALS
Material:		
Freight:		
Tax:		
Fee / Fuel:		
Other Chrg: No		

Today Tons:	599.29	Loads:
Tons To Date:	6,313.86	23
Today Tonnes	543.67	
Tonnes To Date:	5,727.84	

Carrier : 2347024 JOHN MAYVILLE
Vehicle: MI488 John Mayville
License: AF420W
MaxGVW: 80,000
Received: _____
Weighmaster: Colleen LeSage

By acceptance of this ticket (with or without signature), driver accepts on behalf of themselves/their employer sole responsibility to ensure that the load received is within the weight limit authorized by law and shall hold seller harmless against any and all claims with respect to same
CURB DELIVERY ONLY .NOT RESPONSIBLE FOR ANY DAMAGE BEYOND CURB.

Cust: _____

P/D Status: Deliver

Customer Do Not Accept [1] Scale: 1



Plant: 32411

Berlin
368 New Brooklyn Road
Berlin, NJ 08009
856-809-0142

3/20/2017 11:19 In :
Customer: 8638404 THE AMBIENT GROUP LLC
Order : 950949 Camden, NJ. ABC Barrel Project
P.O. :

Tkt. No. 1006027559



Product 114203
Bank Run
S.O. Info: Camden, NJ.
Ship Ref: 327 N. Front St

	Pounds	Kilo
Gross	78,340	35,534
Tare	26,420 *	11,984
Net	51,920	23,551

25.96 Ton 23.55
* Predetermined Tare

	UNIT	TOTALS
Material:		
Freight:		
Tax:		
Fee / Fuel:		
Other Chrg: No		

Today Tons:	625.25	Loads:
Tons To Date:	6,339.82	24
Today Tonnes	567.22	
Tonnes To Date:	5,751.39	

Carrier : 2346970 GEORGE LAZOS TRUCKING
Vehicle: LG003 AS512W
License: AS512W
MaxGVW: 80,000
Received: _____
Weighmaster: Colleen LeSage

By acceptance of this ticket (with or without signature), driver accepts on behalf of themselves/their employer sole responsibility to ensure that the load received is within the weight limit authorized by law and shall hold seller harmless against any and all claims with respect to same
CURB DELIVERY ONLY .NOT RESPONSIBLE FOR ANY DAMAGE BEYOND CURB.

Cust: _____

P/D Status: Deliver

Customer Do Not Accept [2] Scale: 1



Plant: 32411

Berlin

368 New Brooklyn Road
Berlin, NJ 08009
856-809-0142

3/20/2017 12:09 In :
Customer: 8638404 THE AMBIENT GROUP LLC
Order : 950949 Camden, NJ. ABC Barrel Project
P.O. :

Tkt. No. 1006027563



Product 114203
Bank Run
S.O. Info: Camden, NJ.
Ship Ref: 327 N. Front St

	Pounds	Kilo
Gross	77,980	35,371
Tare	27,860 *	12,637
Net	50,120	22,734

25.06 Ton 22.73

* Predetermined Tare

	UNIT	TOTALS
Material:		
Freight:		
Tax:		
Fee / Fuel:		
Other Chrg: No		

Today Tons:	650.31	Loads:
Tons To Date:	6,364.88	25
Today Tonnes	589.95	
Tonnes To Date:	5,774.12	

Carrier : 9249110 CLM CONTRACTING LLC
Vehicle: CLM6 CLM6
License: AT597T
MaxGVW: 80,000

By acceptance of this ticket (with or without signature), driver accepts on behalf of themselves/their employer sole responsibility to ensure that the load received is within the weight limit authorized by law and shall hold seller harmless against any and all claims with respect to same CURB DELIVERY ONLY. NOT RESPONSIBLE FOR ANY DAMAGE BEYOND CURB.

Received: _____
Weighmaster: Colleen LeSage

Cust: _____

P/D Status: Deliver

Customer Copy

Scale: 1



Plant: 32411

Berlin

368 New Brooklyn Road
Berlin, NJ 08009
856-809-0142

3/20/2017 12:11 In :
Customer: 8638404 THE AMBIENT GROUP LLC
Order : 950949 Camden, NJ. ABC Barrel Project
P.O. :

Tkt. No. 1006027564



Product 114203
Bank Run
S.O. Info: Camden, NJ.
Ship Ref: 327 N. Front St

	Pounds	Kilo
Gross	78,620	35,661
Tare	26,240 *	11,902
Net	52,380	23,759

26.19 Ton 23.76

* Predetermined Tare

	UNIT	TOTALS
Material:		
Freight:		
Tax:		
Fee / Fuel:		
Other Chrg: No		

Today Tons:	676.50	Loads:
Tons To Date:	6,391.07	26
Today Tonnes	613.71	
Tonnes To Date:	5,797.88	

By acceptance of this ticket (with or without signature), driver accepts on behalf of themselves/their employer sole responsibility to ensure that the load received is within the weight limit authorized by law and shall hold seller harmless against any and all claims with respect to same CURB DELIVERY ONLY. NOT RESPONSIBLE FOR ANY DAMAGE BEYOND CURB.

Carrier : 2347243 A P SIMIONE
Vehicle: SA194 Simione
License: AB423G
MaxGVW: 80,000

Received: _____
Weighmaster: Colleen LeSage

Cust: _____

P/D Status: Deliver

Customer Do Not Accept [3]

Scale: 1



Plant: 32411

Berlin

368 New Brooklyn Road
Berlin, NJ 08009
856-809-0142

3/20/2017 12:13

In :

Customer: 8638404 THE AMBIENT GROUP LLC

Order : 950949 Camden, NJ. ABC Barrel Project

P.O. :

Tkt. No. 1006027565

Product 114203

Bank Run

S.O. Info: Camden, NJ.

Ship Ref: 327 N. Front St



	Pounds	Kilo
Gross	78,280	35,507
Tare	27,680 *	12,555
Net	50,600	22,952

25.30 Ton 22.95

* Predetermined Tare

Today Tons:	701.80	Loads:
Tons To Date:	6,416.37	27
Today Tonnes	636.66	
Tonnes To Date:	5,820.83	

	UNIT	TOTALS
Material:		
Freight:		
Tax:		
Fee / Fuel:		
Other Chrg: No		

Carrier : 3804135 MOD HAULING SERVICES

Vehicle: MOD105 MOD Hauling Services

License: AT496J

MaxGVW: 80000

Received: *[Signature]*

Weighmaster: Colleen LeSage

By acceptance of this ticket (with or without signature), driver accepts on behalf of themselves/their employer sole responsibility to ensure that the load received is within the weight limit authorized by law and shall hold seller harmless against any and all claims with respect to same CURB DELIVERY ONLY. NOT RESPONSIBLE FOR ANY DAMAGE BEYOND CURB.

Cust: _____

P/D Status: Deliver

Customer Copy

Scale: 1



Plant: 32411

368 New Brooklyn Road
Berlin, NJ 08009
856-809-0142

3/20/2017 12:16

In :

Customer: 8638404 THE AMBIENT GROUP LLC

Order : 950949 Camden, NJ. ABC Barrel Project

P.O. :

Tkt. No. 1006027566

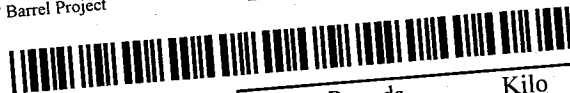

Product 114203

Bank Run

S.O. Info: Camden, NJ.

Ship Ref: 327 N. Front St

	Pounds	Kilo
Gross	76,140	34,537
Tare	23,340 *	10,587
Net	52,800	23,950

26.40 Ton 23.95

* Predetermined Tare

Today Tons:	728.20	Loads:
Tons To Date:	6,442.77	28
Today Tonnes	660.61	
Tonnes To Date:	5,844.78	

By acceptance of this ticket (with or without signature), driver accepts on behalf of themselves/their employer sole responsibility to ensure that the load received is within the weight limit authorized by law and shall hold seller harmless against any and all claims with respect to same CURB DELIVERY ONLY. NOT RESPONSIBLE FOR ANY DAMAGE BEYOND CURB.

Cust: _____

Customer Do Not Accept [3]

Scale: 1

	UNIT	TOTALS
Material:		
Freight:		
Tax:		
Fee / Fuel:		
Other Chrg: No		

Carrier : 8515471 CALLE TRUCKING LLC

Vehicle: CALLE9 AG07469

License: AG07469

MaxGVW: 80,000

Received: *[Signature]*

Weighmaster: Colleen LeSage

P/D Status: Deliver



Plant: 32411

Berlin

368 New Brooklyn Road
Berlin, NJ 08009
856-809-0142

3/20/2017 12:19 In :
Customer: 8638404 THE AMBIENT GROUP LLC
Order : 950949 Camden, NJ. ABC Barrel Project
P.O. :

Tkt. No. 1006027567

Product 114203
Bank Run
S.O. Info: Camden, NJ.
Ship Ref: 327 N. Front St



	Pounds	Kilo
Gross	77,220	35,026
Tare	24,660 *	11,186
Net	52,560	23,841

26.28 Ton 23.84

* Predetermined Tare

	UNIT	TOTALS
Material:		
Freight:		
Tax:		
Fee / Fuel:		
Other Chrg:	No	

Today Tons:	754.48	Loads:
Tons To Date:	6,469.05	29
Today Tonnes	684.45	
Tonnes To Date:	5,868.62	

Carrier : 2346970 GEORGE LAZOS TRUCKING
Vehicle: LG004 AP213T
License: LG004
MaxGVW: 80,000

By acceptance of this ticket (with or without signature), driver accepts on behalf of themselves/their employer sole responsibility to ensure that the load received is within the weight limit authorized by law and shall hold seller harmless against any and all claims with respect to same CURB DELIVERY ONLY. NOT RESPONSIBLE FOR ANY DAMAGE BEYOND CURB.

Received: _____
Weighmaster: Colleen LeSage

Cust: _____

P/D Status: Deliver

Customer Copy

Scale: 1



Plant: 32411

Berlin

368 New Brooklyn Road
Berlin, NJ 08009
856-809-0142

3/20/2017 12:22 In :
Customer: 8638404 THE AMBIENT GROUP LLC
Order : 950949 Camden, NJ. ABC Barrel Project
P.O. :

Tkt. No. 1006027569

Product 114203
Bank Run
S.O. Info: Camden, NJ.
Ship Ref: 327 N. Front St

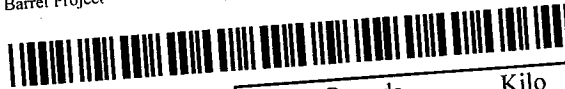

	Pounds	Kilo
Gross	78,260	35,498
Tare	26,100 *	11,839
Net	52,160	23,659

26.08 Ton 23.66

* Predetermined Tare

	UNIT	TOTALS
Material:		
Freight:		
Tax:		
Fee / Fuel:		
Other Chrg:	No	

Today Tons:	806.57	Loads:
Tons To Date:	6,521.14	31
Today Tonnes	731.71	
Tonnes To Date:	5,915.88	

Carrier : 2347809 ROBBINS & SONS HAULING IN
Vehicle: RY093 AS527V
License: AS527V
MaxGVW: 80,000
Received: _____
Weighmaster: Colleen LeSage

By acceptance of this ticket (with or without signature), driver accepts on behalf of themselves/their employer sole responsibility to ensure that the load received is within the weight limit authorized by law and shall hold seller harmless against any and all claims with respect to same CURB DELIVERY ONLY. NOT RESPONSIBLE FOR ANY DAMAGE BEYOND CURB.

Cust: _____

Customer Do Not Accept [!]

Scale: 1



Plant: 32411

Berlin
368 New Brooklyn Road
Berlin, NJ 08009
856-809-0142

3/20/2017 12:25 In:
Customer: 8638404 THE AMBIENT GROUP LLC
Order : 950949 Camden, NJ. ABC Barrel Project
P.O. :

Tkt. No. 1006027570

Product 114203
Bank Run
S.O. Info: Camden, NJ.
Ship Ref: 327 N. Front St



	Pounds	Kilo
Gross	78,880	35,779
Tare	27,140 *	12,310
Net	51,740	23,469

25.87 Ton 23.47

* Predetermined Tare

	UNIT	TOTALS
Material:		
Freight:		
Tax:		
Fee / Fuel:		
Other Chrg: No		

Today Tons:	832.44	Loads:
Tons To Date:	6,547.01	32
Today Tonnes	755.18	
Tonnes To Date:	5,939.35	

Carrier : 2347631 R A DIMARIA
Vehicle: DY026 DiMaria
License: AS200U
MaxGVW: 80,000
Received: 
Weighmaster: Colleen LeSage

By acceptance of this ticket (with or without signature), driver accepts on behalf of themselves/their employer sole responsibility to ensure that the load received is within the weight limit authorized by law and shall hold seller harmless against any and all claims with respect to same CURB DELIVERY ONLY. NOT RESPONSIBLE FOR ANY DAMAGE BEYOND CURB.

Cust: _____

P/D Status: Deliver

Customer Do Not Accept [2] Scale: 1



Plant: 32411

Berlin
368 New Brooklyn Road
Berlin, NJ 08009
856-809-0142

3/20/2017 12:52 In:
Customer: 8638404 THE AMBIENT GROUP LLC
Order : 950949 Camden, NJ. ABC Barrel Project
P.O. :

Tkt. No. 1006027573

Product 114203
Bank Run
S.O. Info: Camden, NJ.
Ship Ref: 327 N. Front St



	Pounds	Kilo
Gross	78,740	35,716
Tare	26,420 *	11,984
Net	52,320	23,732

26.16 Ton 23.73

* Predetermined Tare

	UNIT	TOTALS
Material:		
Freight:		
Tax:		
Fee / Fuel:		
Other Chrg: No		

Today Tons:	859.84	Loads:
Tons To Date:	6,574.41	33
Today Tonnes	780.03	
Tonnes To Date:	5,964.20	

Carrier : 2346970 GEORGE LAZOS TRUCKING
Vehicle: LG003 AS512W
License: AS512W
MaxGVW: 80,000
Received: _____
Weighmaster: Colleen LeSage

By acceptance of this ticket (with or without signature), driver accepts on behalf of themselves/their employer sole responsibility to ensure that the load received is within the weight limit authorized by law and shall hold seller harmless against any and all claims with respect to same CURB DELIVERY ONLY. NOT RESPONSIBLE FOR ANY DAMAGE BEYOND CURB.

Cust: _____

P/D Status: Deliver

Customer Do Not Accept [1] Scale: 1



Plant: 32411

Berlin

368 New Brooklyn Road
Berlin, NJ 08009
856-809-0142

3/20/2017 12:27 In :
Customer: 8638404 THE AMBIENT GROUP LLC
Order : 950949 Camden, NJ. ABC Barrel Project
P.O. :

Tkt. No. 1006027571

Product 114203
Bank Run
S.O. Info: Camden, NJ.
Ship Ref: 327 N. Front St



	Pounds	Kilo
Gross	79,100	35,879
Tare	24,600 *	11,158
Net	54,500	24,721

27.25 Ton 24.72
* Predetermined Tare

	UNIT	TOTALS
Material:		
Freight:		
Tax:		
Fee / Fuel:		
Other Chrg: No		

Today Tons:	859.69	Loads:
Tons To Date:	6,574.26	33
Today Tonnes	779.90	
Tonnes To Date:	5,964.07	

Carrier : 2347024 JOHN MAYVILLE
Vehicle: MI488 John Mayville
License: AF420W
MaxGVW: 80,000

By acceptance of this ticket (with or without signature), driver accepts on behalf of themselves/their employer sole responsibility to ensure that the load received is within the weight limit authorized by law and shall holdseller harmless against any and all claims with respect to same CURB DELIVERY ONLY. NOT RESPONSIBLE FOR ANY DAMAGE BEYOND CURB.

Received: _____
Weighmaster: Colleen LeSage

Cust: _____

P/D Status: Deliver

Customer Copy

Scale: 1



Plant: 32411

Berlin

368 New Brooklyn Road
Berlin, NJ 08009
856-809-0142

3/20/2017 13:14 In : 12:58:14
Customer: 8638404 THE AMBIENT GROUP LLC
Order : 950949 Camden, NJ. ABC Barrel Project
P.O. :

Tkt. No. 1006027574

Product 114203
Bank Run
S.O. Info: Camden, NJ.
Ship Ref: 327 N. Front St



	Pounds	Kilo
Gross	79,860	36,224
Tare	25,840 *	11,721
Net	54,020	24,503

27.01 Ton 24.50
* Predetermined Tare

	UNIT	TOTALS
Material:		
Freight:		
Tax:		
Fee / Fuel:		
Other Chrg: No		

Today Tons:	886.85	Loads:
Tons To Date:	6,601.42	34
Today Tonnes	804.54	
Tonnes To Date:	5,988.71	

Carrier : 8647386 TURKEYROOST TRANSPORT
Vehicle: TUR001 Turkeyroost
License: AP182A
MaxGVW: 80,000

By acceptance of this ticket (with or without signature), driver accepts on behalf of themselves/their employer sole responsibility to ensure that the load received is within the weight limit authorized by law and shall holdseller harmless against any and all claims with respect to same CURB DELIVERY ONLY. NOT RESPONSIBLE FOR ANY DAMAGE BEYOND CURB.

Received: _____
Weighmaster: Colleen LeSage

Cust: _____

P/D Status: Deliver

Customer Copy

Scale: 1



Plant: 32411

Berlin
368 New Brooklyn Road
Berlin, NJ 08009
856-809-0142

3/20/2017 14:03 In:
Customer: 8638404 THE AMBIENT GROUP LLC
Order : 950949 Camden, NJ. ABC Barrel Project
P.O. :

Tkt. No. 1006027578

Product 114203
Bank Run
S.O. Info: Camden, NJ.
Ship Ref: 327 N. Front St



	Pounds	Kilo
Gross	78,880	35,779
Tare	26,240 *	11,902
Net	52,640	23,877

26.32 Ton 23.88

* Predetermined Tare

	UNIT	TOTALS
Material:		
Freight:		
Tax:		
Fee / Fuel:		
Other Chrg: No		

Today Tons:	913.17	Loads:
Tons To Date:	6,627.74	35
Today Tonnes	828.41	
Tonnes To Date:	6,012.58	

Carrier : 2347243 A P SIMIONE
Vehicle: SA194 Simione
License: AB423G
MaxGVW: 80,000

By acceptance of this ticket (with or without signature), driver accepts on behalf of themselves/their employer sole responsibility to ensure that the load received is within the weight limit authorized by law and shall hold seller harmless against any and all claims with respect to same CURB DELIVERY ONLY. NOT RESPONSIBLE FOR ANY DAMAGE BEYOND CURB.

Received: _____ Cust: _____

Weighmaster: Colleen LeSage

P/D Status: Deliver

Customer Do Not Accept [2] Scale: 1



Plant: 32411

Berlin
368 New Brooklyn Road
Berlin, NJ 08009
856-809-0142

3/20/2017 14:05 In:
Customer: 8638404 THE AMBIENT GROUP LLC
Order : 950949 Camden, NJ. ABC Barrel Project
P.O. :

Tkt. No. 1006027579

Product 114203
Bank Run
S.O. Info: Camden, NJ.
Ship Ref: 327 N. Front St



	Pounds	Kilo
Gross	75,740	34,355
Tare	23,340 *	10,587
Net	52,400	23,768

26.20 Ton 23.77

* Predetermined Tare

	UNIT	TOTALS
Material:		
Freight:		
Tax:		
Fee / Fuel:		
Other Chrg: No		

Today Tons:	939.37	Loads:
Tons To Date:	6,653.94	36
Today Tonnes	852.18	
Tonnes To Date:	6,036.35	

Carrier : 8515471 CALLE TRUCKING LLC
Vehicle: CALLE9 AG07469
License: AG07469
MaxGVW: 80,000

By acceptance of this ticket (with or without signature), driver accepts on behalf of themselves/their employer sole responsibility to ensure that the load received is within the weight limit authorized by law and shall hold seller harmless against any and all claims with respect to same CURB DELIVERY ONLY. NOT RESPONSIBLE FOR ANY DAMAGE BEYOND CURB.

Received: Colleen LeSage Cust: _____

Weighmaster: Colleen LeSage

P/D Status: Deliver

Customer Do Not Accept [3] Scale: 1



Plant: 32411

Berlin

368 New Brooklyn Road
Berlin, NJ 08009
856-809-0142

3/20/2017 14:07

In :

Customer: 8638404 THE AMBIENT GROUP LLC

Order : 950949 Camden, NJ. ABC Barrel Project

P.O. :

Tkt. No. 1006027580



Product 114203

Bank Run

S.O. Info: Camden, NJ.

Ship Ref: 327 N. Front St

	Pounds	Kilo
Gross	76,560	34,727
Tare	24,660 *	11,186
Net	51,900	23,541

25.95 Ton 23.54

* Predetermined Tare

	UNIT	TOTALS
Material:		
Freight:		
Tax:		
Fee / Fuel:		
Other Chrg:	No	

Today Tons:	965.32	Loads:
Tons To Date:	6,679.89	37
Today Tonnes	875.72	
Tonnes To Date:	6,059.89	

By acceptance of this ticket (with or without signature), driver accepts on behalf of themselves/their employer sole responsibility to ensure that the load received is within the weight limit authorized by law and shall hold self harmless against any and all claims with respect to same CURB DELIVERY ONLY. NOT RESPONSIBLE FOR ANY DAMAGE BEYOND CURB.

Carrier : 2346970 GEORGE LAZOS TRUCKING

Vehicle: LG004 AP213T

License: LG004

MaxGVW: 80,000

Received: _____

Cust: _____

Weighmaster: Colleen LeSage

P/D Status: Deliver

Customer Copy

Scale: 1



Plant: 32411

Berlin

368 New Brooklyn Road
Berlin, NJ 08009
856-809-0142

3/21/2017 07:11 In: 6:45:13
Customer: 8638404 THE AMBIENT GROUP LLC
Order : 950949 Camden, NJ. ABC Barrel Project
P.O. :

Tkt. No. 1006027587



Product 114203
Bank Run
S.O. Info: Camden, NJ.
Ship Ref: 327 N. Front St

	Pounds	Kilo
Gross	78,740	35,716
Tare	28,240	12,809
Net	50,500	22,906
	25.25 Ton	22.91

	UNIT	TOTALS
Material:		
Freight:		
Tax:		
Fee / Fuel:		
Other Chrg: No		

Today Tons:	25.25	Loads:
Tons To Date:	6,705.14	1
Today Tonnes	22.91	
Tonnes To Date:	6,082.80	

Carrier : 8040648 GJ SCOTT LLC
Vehicle: GS16 GS16
License: AT639K
MaxGVW: 80,000

By acceptance of this ticket (with or without signature), driver accepts on behalf of themselves/their employer sole responsibility to ensure that the load received is within the weight limit authorized by law and shall hold seller harmless against any and all claims with respect to same CURB DELIVERY ONLY. NOT RESPONSIBLE FOR ANY DAMAGE BEYOND CURB.

Received: _____
Weighmaster: Colleen LeSage
P/D Status: Deliver

Cust: _____
 Customer Do Not Accept [2] Scale: 1



Plant: 32411

Berlin

368 New Brooklyn Road
Berlin, NJ 08009
856-809-0142

3/21/2017 07:18 In: 6:45:40
Customer: 8638404 THE AMBIENT GROUP LLC
Order : 950949 Camden, NJ. ABC Barrel Project
P.O. :

Tkt. No. 1006027588



Product 114203
Bank Run
S.O. Info: Camden, NJ.
Ship Ref: 327 N. Front St

	Pounds	Kilo
Gross	77,760	35,271
Tare	27,120	12,301
Net	50,640	22,970
	25.32 Ton	22.97

	UNIT	TOTALS
Material:		
Freight:		
Tax:		
Fee / Fuel:		
Other Chrg: No		

Today Tons:	50.57	Loads:
Tons To Date:	6,730.46	2
Today Tonnes	45.88	
Tonnes To Date:	6,105.77	

Carrier : 8040648 GJ SCOTT LLC
Vehicle: GS6 GS6
License: AK761C
MaxGVW: 80,000

By acceptance of this ticket (with or without signature), driver accepts on behalf of themselves/their employer sole responsibility to ensure that the load received is within the weight limit authorized by law and shall hold seller harmless against any and all claims with respect to same CURB DELIVERY ONLY. NOT RESPONSIBLE FOR ANY DAMAGE BEYOND CURB.

Received: _____
Weighmaster: Colleen LeSage
P/D Status: Deliver

Cust: _____
 Customer Do Not Accept [3] Scale: 1



Plant: 32411

Berlin
368 New Brooklyn Road
Berlin, NJ 08009
856-809-0142

3/21/2017 07:20 In: 6:28:02
Customer: 8638404 THE AMBIENT GROUP LLC
Order: 950949 Camden, NJ. ABC Barrel Project
P.O.:

Tkt. No. 1006027589

Product 114203
Bank Run
S.O. Info: Camden, NJ.
Ship Ref: 327 N. Front St



	Pounds	Kilo
Gross	78,600	35,652
Tare	26,480	12,011
Net	52,120	23,641
26.06 Ton		23.64

	UNIT	TOTALS
Material:		
Freight:		
Tax:		
Fee / Fuel:		
Other Chrg: No		

Today Tons:	76.63	Loads:
Tons To Date:	6,756.52	3
Today Tonnes	69.52	
Tonnes To Date:	6,129.41	

Carrier: 2347243 A P SIMIONE
Vehicle: SA194 Simione
License: AB423G
MaxGVW: 80,000

By acceptance of this ticket (with or without signature), driver accepts on behalf of themselves/their employer sole responsibility to ensure that the load received is within the weight limit authorized by law and shall hold seller harmless against any and all claims with respect to same CURB DELIVERY ONLY. NOT RESPONSIBLE FOR ANY DAMAGE BEYOND CURB.

Received: _____
Weighmaster: Colleen LeSage

Cust: _____

P/D Status: Deliver

Customer Do Not Accept [2] Scale: 1



Plant: 32411

Berlin
368 New Brooklyn Road
Berlin, NJ 08009
856-809-0142

3/21/2017 07:21 In: 6:56:53
Customer: 8638404 THE AMBIENT GROUP LLC
Order: 950949 Camden, NJ. ABC Barrel Project
P.O.:

Tkt. No. 1006027590

Product 114203
Bank Run
S.O. Info: Camden, NJ.
Ship Ref: 327 N. Front St



	Pounds	Kilo
Gross	78,200	35,471
Tare	27,720	12,574
Net	50,480	22,897
25.24 Ton		22.90

	UNIT	TOTALS
Material:		
Freight:		
Tax:		
Fee / Fuel:		
Other Chrg: No		

Today Tons:	101.87	Loads:
Tons To Date:	6,781.76	4
Today Tonnes	92.41	
Tonnes To Date:	6,152.31	

Carrier: 3804135 MOD HAULING SERVICES
Vehicle: MOD105 MOD Hauling Services
License: AT496J
MaxGVW: 80,000

By acceptance of this ticket (with or without signature), driver accepts on behalf of themselves/their employer sole responsibility to ensure that the load received is within the weight limit authorized by law and shall hold seller harmless against any and all claims with respect to same CURB DELIVERY ONLY. NOT RESPONSIBLE FOR ANY DAMAGE BEYOND CURB.

Received: MLD
Weighmaster: Colleen LeSage

Cust: _____

P/D Status: Deliver

Customer Do Not Accept [3] Scale: 1



Plant: 32411

Berlin

368 New Brooklyn Road
Berlin, NJ 08009
856-809-0142

3/21/2017 07:23 In: 7:06:04
Customer: 8638404 THE AMBIENT GROUP LLC
Order : 950949 Camden, NJ. ABC Barrel Project
P.O. :

Tkt. No. 1006027591



Product 114203
Bank Run
S.O. Info: Camden, NJ.
Ship Ref: 327 N. Front St

	Pounds	Kilo
Gross	78,060	35,407
Tare	27,100	12,292
Net	50,960	23,115
	25.48 Ton	23.12

UNIT	TOTALS
Material:	
Freight:	
Tax:	
Fee / Fuel:	
Other Chrg: No	

Today Tons:	127.35	Loads:
Tons To Date:	6,807.24	5
Today Tonnes	115.53	
Tonnes To Date:	6,175.42	

By acceptance of this ticket (with or without signature), driver accepts on behalf of themselves/their employer sole responsibility to ensure that the load received is within the weight limit authorized by law and shall hold seller harmless against any and all claims with respect to same CURB DELIVERY ONLY. NOT RESPONSIBLE FOR ANY DAMAGE BEYOND CURB.

Carrier : 2347631 R A DIMARIA
Vehicle: DY026 DiMaria
License: AS2001
MaxGVW: 80,000

Received:
Weighmaster: Colleen LeSage

Cust: _____

P/D Status: Deliver

Customer Do Not Accept [3] Scale: 1



Plant: 32411

Berlin

368 New Brooklyn Road
Berlin, NJ 08009
856-809-0142

3/21/2017 08:28 In: 6:27:48
Customer: 8638404 THE AMBIENT GROUP LLC
Order : 950949 Camden, NJ. ABC Barrel Project
P.O. :

Tkt. No. 1006027599



Product 114203
Bank Run
S.O. Info: Camden, NJ.
Ship Ref: 327 N. Front St

	Pounds	Kilo
Gross	79,180	35,915
Tare	26,640	12,084
Net	52,540	23,832
	26.27 Ton	23.83

UNIT	TOTALS
Material:	
Freight:	
Tax:	
Fee / Fuel:	
Other Chrg: No	

Today Tons:	153.62	Loads:
Tons To Date:	6,833.51	6
Today Tonnes	139.36	
Tonnes To Date:	6,199.26	

By acceptance of this ticket (with or without signature), driver accepts on behalf of themselves/their employer sole responsibility to ensure that the load received is within the weight limit authorized by law and shall hold seller harmless against any and all claims with respect to same CURB DELIVERY ONLY. NOT RESPONSIBLE FOR ANY DAMAGE BEYOND CURB.

Carrier : 2347032 ROCKY LOGIOVINO TRUCKIN
Vehicle: LR060 Rocky
License: AM637B
MaxGVW: 80,000

Received: _____
Weighmaster: Colleen LeSage

Cust: _____

P/D Status: Deliver

Customer Do Not Accept [2] Scale: 1



Plant: 32411

Berlin

368 New Brooklyn Road
Berlin, NJ 08009
856-809-0142,

3/21/2017 09:15

In :

Customer: 8638404 THE AMBIENT GROUP LLC

Order : 950949 Camden, NJ. ABC Barrel Project

P.O. :

Tkt. No. 1006027604

Product 114203

Bank Run

S.O. Info: Camden, NJ.

Ship Ref: 327 N. Front St



	Pounds	Kilo
Gross	78,820	35,752
Tare	26,480 *	12,011
Net	52,340	23,741

26.17 Ton 23.74

* Predetermined Tare

UNIT	TOTALS
Material:	
Freight:	
Tax:	
Fee / Fuel:	
Other Chrg: <u>No</u>	

Today Tons:	179.79	Loads:
Tons To Date:	6,859.68	7
Today Tonnes	163.10	
Tonnes To Date:	6,223.00	

By acceptance of this ticket (with or without signature), driver accepts on behalf of themselves/their employer sole responsibility to ensure that the load received is within the weight limit authorized by law and shall hold seller harmless against any and all claims with respect to same CURB DELIVERY ONLY. NOT RESPONSIBLE FOR ANY DAMAGE BEYOND CURB.

Carrier : 2347243 A P SIMIONE

Vehicle: SA194 Simione

License: AB423G

MaxGVW: 80,000

Received: _____

Cust: _____

Weighmaster: Colleen LeSage

P/D Status: Deliver

Customer Do Not Accept [2] Scale: 1



Plant: 32411

Berlin

368 New Brooklyn Road
Berlin, NJ 08009
856-809-0142,

3/21/2017 09:18

In :

Customer: 8638404 THE AMBIENT GROUP LLC

Order : 950949 Camden, NJ. ABC Barrel Project

P.O. :

Tkt. No. 1006027605

Product 114203

Bank Run

S.O. Info: Camden, NJ.

Ship Ref: 327 N. Front St



	Pounds	Kilo
Gross	78,040	35,398
Tare	27,720 *	12,574
Net	50,320	22,825

25.16 Ton 22.82

* Predetermined Tare

UNIT	TOTALS
Material:	
Freight:	
Tax:	
Fee / Fuel:	
Other Chrg: <u>No</u>	

Today Tons:	204.95	Loads:
Tons To Date:	6,884.84	8
Today Tonnes	185.93	
Tonnes To Date:	6,245.82	

By acceptance of this ticket (with or without signature), driver accepts on behalf of themselves/their employer sole responsibility to ensure that the load received is within the weight limit authorized by law and shall hold seller harmless against any and all claims with respect to same CURB DELIVERY ONLY. NOT RESPONSIBLE FOR ANY DAMAGE BEYOND CURB.

Carrier : 3804135 MOD HAULING SERVICES

Vehicle: MOD105 MOD Hauling Services

License: AT496J

MaxGVW: 80,000

Received: MS

Cust: _____

Weighmaster: Colleen LeSage

P/D Status: Deliver

Customer Do Not Accept [1] Scale: 1



Plant: 32411

Berlin
368 New Brooklyn Road
Berlin, NJ 08009
856-809-0142

3/21/2017 09:22 In:
Customer: 8638404 THE AMBIENT GROUP LLC
Order : 950949 Camden, NJ. ABC Barrel Project
P.O. :

Tkt. No. 1006027606

Product 114203
Bank Run
S.O. Info: Camden, NJ.
Ship Ref: 327 N. Front St



	Pounds	Kilo
Gross	79,100	35,879
Tare	28,240 *	12,809
Net	50,860	23,070

25.43 Ton 23.07

* Predetermined Tare

	UNIT	TOTALS
Material:		
Freight:		
Tax:		
Fee / Fuel:		
Other Chrg: No		

Today Tons:	230.38	Loads:
Tons To Date:	6,910.27	9
Today Tonnes	209.00	
Tonnes To Date:	6,268.89	

Carrier : 8040648 GJ SCOTT LLC
Vehicle: GS16 GS16
License: AT639K
MaxGVW: 80,000

By acceptance of this ticket (with or without signature), driver accepts on behalf of themselves/their employer sole responsibility to ensure that the load received is within the weight limit authorized by law and shall hold seller harmless against any and all claims with respect to same CURB DELIVERY ONLY. NOT RESPONSIBLE FOR ANY DAMAGE BEYOND CURB.

Received:

Cust: _____

Weighmaster: Colleen LeSage

P/D Status: Deliver

Customer Do Not Accept [2] Scale: 1



Plant: 32411

Berlin
368 New Brooklyn Road
Berlin, NJ 08009
856-809-0142

3/21/2017 09:24 In:
Customer: 8638404 THE AMBIENT GROUP LLC
Order : 950949 Camden, NJ. ABC Barrel Project
P.O. :

Tkt. No. 1006027607

Product 114203
Bank Run
S.O. Info: Camden, NJ.
Ship Ref: 327 N. Front St



	Pounds	Kilo
Gross	77,540	35,172
Tare	27,120 *	12,301
Net	50,420	22,870

25.21 Ton 22.87

* Predetermined Tare

	UNIT	TOTALS
Material:		
Freight:		
Tax:		
Fee / Fuel:		
Other Chrg: No		

Today Tons:	255.59	Loads:
Tons To Date:	6,935.48	10
Today Tonnes	231.87	
Tonnes To Date:	6,291.76	

Carrier : 8040648 GJ SCOTT LLC
Vehicle: GS6 GS6
License: AK761C
MaxGVW: 80,000

By acceptance of this ticket (with or without signature), driver accepts on behalf of themselves/their employer sole responsibility to ensure that the load received is within the weight limit authorized by law and shall hold seller harmless against any and all claims with respect to same CURB DELIVERY ONLY. NOT RESPONSIBLE FOR ANY DAMAGE BEYOND CURB.

Received:

Cust: _____

Weighmaster: Colleen LeSage

P/D Status: Deliver

Customer Do Not Accept [3] Scale: 1



Plant: 32411

Berlin
368 New Brooklyn Road
Berlin, NJ 08009
856-809-0142

3/21/2017 09:27 In :
Customer: 8638404 THE AMBIENT GROUP LLC
Order : 950949 Camden, NJ. ABC Barrel Project
P.O. :

Tkt. No. 1006027608



Product 114203
Bank Run
S.O. Info: Camden, NJ.
Ship Ref: 327 N. Front St

	Pounds	Kilo
Gross	78,160	35,453
Tare	27,100 *	12,292
Net	51,060	23,160

25.53 Ton 23.16

* Predetermined Tare

Today Tons:	281.12	Loads:
Tons To Date:	6,961.01	11
Today Tonnes	255.03	
Tonnes To Date:	6,314.92	

By acceptance of this ticket (with or without signature), driver accepts on behalf of themselves/their employer sole responsibility to ensure that the load received is within the weight limit authorized by law and shall hold seller harmless against any and all claims with respect to same CURB DELIVERY ONLY. NOT RESPONSIBLE FOR ANY DAMAGE BEYOND CURB.

UNIT	TOTALS
Material:	
Freight:	
Tax:	
Fee / Fuel:	
Other Chrg: No	

Carrier : 2347631 R A DIMARIA

Vehicle: DY026 DiMaria

License: AS200U

MaxGVW: 80,000

Received: 

Cust: _____

Weighmaster: Colleen LeSage

P/D Status: Deliver

Customer Do Not Accept [3] Scale: 1



Plant: 32411

Berlin
368 New Brooklyn Road
Berlin, NJ 08009
856-809-0142

3/21/2017 10:00 In :
Customer: 8638404 THE AMBIENT GROUP LLC
Order : 950949 Camden, NJ. ABC Barrel Project
P.O. :

Tkt. No. 1006027612



Product 114203
Bank Run
S.O. Info: Camden, NJ.
Ship Ref: 327 N. Front St

	Pounds	Kilo
Gross	79,740	36,169
Tare	26,640 *	12,084
Net	53,100	24,086

26.55 Ton 24.09

* Predetermined Tare

Today Tons:	307.67	Loads:
Tons To Date:	6,987.56	12
Today Tonnes	279.11	
Tonnes To Date:	6,339.01	

By acceptance of this ticket (with or without signature), driver accepts on behalf of themselves/their employer sole responsibility to ensure that the load received is within the weight limit authorized by law and shall hold seller harmless against any and all claims with respect to same CURB DELIVERY ONLY. NOT RESPONSIBLE FOR ANY DAMAGE BEYOND CURB.

UNIT	TOTALS
Material:	
Freight:	
Tax:	
Fee / Fuel:	
Other Chrg: No	

Carrier : 2347032 ROCKY LOGIOVINO TRUCKIN

Vehicle: LR060 Rocky

License: AM637B

MaxGVW: 80,000

Received: _____

Cust: _____

Weighmaster: Colleen LeSage

P/D Status: Deliver

Customer Do Not Accept [3] Scale: 1



Plant: 32411

Berlin
368 New Brooklyn Road
Berlin, NJ 08009
856-809-0142

3/21/2017 10:43 In:
Customer: 8638404 THE AMBIENT GROUP LLC
Order : 950949 Camden, NJ. ABC Barrel Project
P.O. :

Tkt. No. 1006027617



Product 114203
Bank Run
S.O. Info: Camden, NJ.
Ship Ref: 327 N. Front St

	Pounds	Kilo
Gross	79,720	36,160
Tare	26,480 *	12,011
Net	53,240	24,149

26.62 Ton 24.15

* Predetermined Tare

	UNIT	TOTALS
Material:		
Freight:		
Tax:		
Fee / Fuel:		
Other Chrg: No		

Today Tons:	334.29	Loads:
Tons To Date:	7,014.18	13
Today Tonnes	303.26	
Tonnes To Date:	6,363.16	

By acceptance of this ticket (with or without signature), driver accepts on behalf of themselves/their employer sole responsibility to ensure that the load received is within the weight limit authorized by law and shall hold seller harmless against any and all claims with respect to same CURB DELIVERY ONLY. NOT RESPONSIBLE FOR ANY DAMAGE BEYOND CURB.

Carrier : 2347243 A P SIMIONE
Vehicle: SA194 Simione
License: AB423G
MaxGVW: 80,000

Received: _____ Cust: _____

Weighmaster: Colleen LeSage

P/D Status: Deliver

Customer Do Not Accept [2] Scale: 1



Plant: 32411

Berlin
368 New Brooklyn Road
Berlin, NJ 08009
856-809-0142

3/21/2017 10:44 In:
Customer: 8638404 THE AMBIENT GROUP LLC
Order : 950949 Camden, NJ. ABC Barrel Project
P.O. :

Tkt. No. 1006027618



Product 114203
Bank Run
S.O. Info: Camden, NJ.
Ship Ref: 327 N. Front St

	Pounds	Kilo
Gross	78,740	35,716
Tare	27,720 *	12,574
Net	51,020	23,142

25.51 Ton 23.14

* Predetermined Tare

	UNIT	TOTALS
Material:		
Freight:		
Tax:		
Fee / Fuel:		
Other Chrg: No		

Today Tons:	359.80	Loads:
Tons To Date:	7,039.69	14
Today Tonnes	326.41	
Tonnes To Date:	6,386.30	

By acceptance of this ticket (with or without signature), driver accepts on behalf of themselves/their employer sole responsibility to ensure that the load received is within the weight limit authorized by law and shall hold seller harmless against any and all claims with respect to same CURB DELIVERY ONLY. NOT RESPONSIBLE FOR ANY DAMAGE BEYOND CURB.

Carrier : 3804135 MOD HAULING SERVICES
Vehicle: MOD105 MOD Hauling Services
License: AT496J
MaxGVW: 80,000

Received: _____ Cust: _____

Weighmaster: Colleen LeSage

P/D Status: Deliver

Customer Do Not Accept [2] Scale: 1



Plant: 32411

Berlin
368 New Brooklyn Road
Berlin, NJ 08009
856-809-0142

3/21/2017 10:47 In:
Customer: 8638404 THE AMBIENT GROUP LLC
Order: 950949 Camden, NJ. ABC Barrel Project
P.O.:

Tkt. No. 1006027619



Product 114203
Bank Run
S.O. Info: Camden, NJ.
Ship Ref: 327 N. Front St

	Pounds	Kilo
Gross	78,940	35,807
Tare	28,240 *	12,809
Net	50,700	22,997

25.35 Ton 23.00
* Predetermined Tare

Material:	UNIT	TOTALS
Freight:		
Tax:		
Fee / Fuel:		
Other Chrg: No		

Today Tons:	385.15	Loads:
Tons To Date:	7,065.04	15
Today Tonnes	349.40	
Tonnes To Date:	6,409.30	

Carrier: 8040648 GJ SCOTT LLC
Vehicle: GS16 GS16
License: AT639K
MaxGVW: 80,000

By acceptance of this ticket (with or without signature), driver accepts on behalf of themselves/their employer sole responsibility to ensure that the load received is within the weight limit authorized by law and shall hold seller harmless against any and all claims with respect to same CURB DELIVERY ONLY. NOT RESPONSIBLE FOR ANY DAMAGE BEYOND CURB.

Received: _____
Weighmaster: Colleen LeSage
P/D Status: Deliver

Cust: _____
Customer Do Not Accept [2] Scale: 1



Plant: 32411

Berlin
368 New Brooklyn Road
Berlin, NJ 08009
856-809-0142

3/21/2017 10:50 In:
Customer: 8638404 THE AMBIENT GROUP LLC
Order: 950949 Camden, NJ. ABC Barrel Project
P.O.:

Tkt. No. 1006027620



Product 114203
Bank Run
S.O. Info: Camden, NJ.
Ship Ref: 327 N. Front St

	Pounds	Kilo
Gross	78,120	35,435
Tare	27,120 *	12,301
Net	51,000	23,133

25.50 Ton 23.13
* Predetermined Tare

Material:	UNIT	TOTALS
Freight:		
Tax:		
Fee / Fuel:		
Other Chrg: No		

Today Tons:	410.65	Loads:
Tons To Date:	7,090.54	16
Today Tonnes	372.54	
Tonnes To Date:	6,432.43	

Carrier: 8040648 GJ SCOTT LLC
Vehicle: GS6 GS6
License: AK761C
MaxGVW: 80,000

By acceptance of this ticket (with or without signature), driver accepts on behalf of themselves/their employer sole responsibility to ensure that the load received is within the weight limit authorized by law and shall hold seller harmless against any and all claims with respect to same CURB DELIVERY ONLY. NOT RESPONSIBLE FOR ANY DAMAGE BEYOND CURB.

Received: _____
Weighmaster: Colleen LeSage
P/D Status: Deliver

Cust: _____
Customer Do Not Accept [3] Scale: 1



Plant: 32411

Berlin
368 New Brooklyn Road
Berlin, NJ 08009
856-809-0142

3/21/2017 10:53 In :
Customer: 8638404 THE AMBIENT GROUP LLC
Order : 950949 Camden, NJ. ABC Barrel Project
P.O. :

Tkt. No. 1006027621



Product 114203
Bank Run
S.O. Info: Camden, NJ.
Ship Ref: 327 N. Front St

	Pounds	Kilo
Gross	77,620	35,208
Tare	27,100 *	12,292
Net	50,520	22,915

25.26 Ton 22.92

* Predetermined Tare

Today Tons:	435.91	Loads:
Tons To Date:	7,115.80	17
Today Tonnes	395.45	
Tonnes To Date:	6,455.35	

By acceptance of this ticket (with or without signature), driver accepts on behalf of themselves/their employer sole responsibility to ensure that the load received is within the weight limit authorized by law and shall hold seller harmless against any and all claims with respect to same CURB DELIVERY ONLY. NOT RESPONSIBLE FOR ANY DAMAGE BEYOND CURB.

UNIT	TOTALS
Material:	
Freight:	
Tax:	
Fee / Fuel:	
Other Chrg: No	

Carrier : 2347631 R A DIMARIA
Vehicle: DY026 DiMaria
License: AS200U
MaxGVW: 80,000

Received: 
Weighmaster: Colleen LeSage

Cust: _____

P/D Status: Deliver

Customer Do Not Accept [3] Scale: 1



Plant: 32411

Berlin
368 New Brooklyn Road
Berlin, NJ 08009
856-809-0142

3/21/2017 10:56 In : 10:34:39
Customer: 8638404 THE AMBIENT GROUP LLC
Order : 950949 Camden, NJ. ABC Barrel Project
P.O. :

Tkt. No. 1006027622



Product 114203
Bank Run
S.O. Info: Camden, NJ.
Ship Ref: 327 N. Front St

	Pounds	Kilo
Gross	76,920	34,890
Tare	24,780	11,240
Net	52,140	23,650

26.07 Ton 23.65

Today Tons:	461.98	Loads:
Tons To Date:	7,141.87	18
Today Tonnes	419.10	
Tonnes To Date:	6,479.00	

By acceptance of this ticket (with or without signature), driver accepts on behalf of themselves/their employer sole responsibility to ensure that the load received is within the weight limit authorized by law and shall hold seller harmless against any and all claims with respect to same CURB DELIVERY ONLY. NOT RESPONSIBLE FOR ANY DAMAGE BEYOND CURB.

UNIT	TOTALS
Material:	
Freight:	
Tax:	
Fee / Fuel:	
Other Chrg: No	

Carrier : 8515471 CALLE TRUCKING LLC
Vehicle: CALLE5 Calle Trucking
License: AF49921
MaxGVW: 80,000

Received: _____
Weighmaster: Colleen LeSage

Cust: _____

P/D Status: Deliver

Customer Do Not Accept [2] Scale: 1



Plant: 32411

Berlin
368 New Brooklyn Road
Berlin, NJ 08009
856-809-0142

3/21/2017 11:23 In :
Customer: 8638404 THE AMBIENT GROUP LLC
Order : 950949 Camden, NJ. ABC Barrel Project
P.O. :

Tkt. No. 1006027624

Product 114203
Bank Run
S.O. Info: Camden, NJ.
Ship Ref: 327 N. Front St



	Pounds	Kilo
Gross	78,780	35,734
Tare	26,640 *	12,084
Net	52,140	23,650

26.07 Ton 23.65
* Predetermined Tare

Material:	UNIT	TOTALS
Freight:		
Tax:		
Fee / Fuel:		
Other Chrg: No		

Today Tons:	488.05	Loads:
Tons To Date:	7,167.94	19
Today Tonnes	442.75	
Tonnes To Date:	6,502.65	

Carrier : 2347032 ROCKY LOGIOVINO TRUCKIN
Vehicle: LR060 Rocky
License: AM637B
MaxGVW: 80,000

By acceptance of this ticket (with or without signature), driver accepts on behalf of themselves/their employer sole responsibility to ensure that the load received is within the weight limit authorized by law and shall hold seller harmless against any and all claims with respect to same CURB DELIVERY ONLY. NOT RESPONSIBLE FOR ANY DAMAGE BEYOND CURB.

Received: _____ Cust: _____
Weighmaster: Colleen LeSage

P/D Status: Deliver

Customer Do Not Accept [2] Scale: 1



Plant: 32411

Berlin
368 New Brooklyn Road
Berlin, NJ 08009
856-809-0142

3/21/2017 11:31 In : 11:16:02
Customer: 8638404 THE AMBIENT GROUP LLC
Order : 950949 Camden, NJ. ABC Barrel Project
P.O. :

Tkt. No. 1006027627

Product 114203
Bank Run
S.O. Info: Camden, NJ.
Ship Ref: 327 N. Front St



	Pounds	Kilo
Gross	79,360	35,997
Tare	26,080	11,830
Net	53,280	24,167

26.64 Ton 24.17

Material:	UNIT	TOTALS
Freight:		
Tax:		
Fee / Fuel:		
Other Chrg: No		

Today Tons:	514.69	Loads:
Tons To Date:	7,194.58	20
Today Tonnes	466.92	
Tonnes To Date:	6,526.81	

Carrier : 8515471 CALLE TRUCKING LLC
Vehicle: CALLE3 Calle Trucking
License: AG15212
MaxGVW: 80,000

By acceptance of this ticket (with or without signature), driver accepts on behalf of themselves/their employer sole responsibility to ensure that the load received is within the weight limit authorized by law and shall hold seller harmless against any and all claims with respect to same CURB DELIVERY ONLY. NOT RESPONSIBLE FOR ANY DAMAGE BEYOND CURB.

Received: _____ Cust: _____
Weighmaster: Colleen LeSage

P/D Status: Deliver

Customer Do Not Accept [3] Scale: 1



Plant: 32411

Berlin
368 New Brooklyn Road
Berlin, NJ 08009
856-809-0142

3/21/2017 12:08 In:
Customer: 8638404 THE AMBIENT GROUP LLC
Order : 950949 Camden, NJ. ABC Barrel Project
P.O. :

Tkt. No. 1006027630



Product 114203
Bank Run
S.O. Info: Camden, NJ.
Ship Ref: 327 N. Front St

	Pounds	Kilo
Gross	78,840	35,761
Tare	26,480 *	12,011
Net	52,360	23,750

26.18 Ton 23.75
* Predetermined Tare

	UNIT	TOTALS
Material:		
Freight:		
Tax:		
Fee / Fuel:		
Other Chrg: No		

Today Tons:	540.87	Loads:
Tons To Date:	7,220.76	21
Today Tonnes	490.67	
Tonnes To Date:	6,550.56	

Carrier : 2347243 A P SIMIONE
Vehicle: SA194 Simione
License: AB423G
MaxGVW: 80,000

By acceptance of this ticket (with or without signature), driver accepts on behalf of themselves/their employer sole responsibility to ensure that the load received is within the weight limit authorized by law and shall hold seller harmless against any and all claims with respect to same CURB DELIVERY ONLY. NOT RESPONSIBLE FOR ANY DAMAGE BEYOND CURB.

Received: _____
Weighmaster: Colleen LeSage

Cust: _____

P/D Status: Deliver

Customer Do Not Accept [2] Scale: 1



Plant: 32411

Berlin
368 New Brooklyn Road
Berlin, NJ 08009
856-809-0142

3/21/2017 12:11 In:
Customer: 8638404 THE AMBIENT GROUP LLC
Order : 950949 Camden, NJ. ABC Barrel Project
P.O. :

Tkt. No. 1006027631



Product 114203
Bank Run
S.O. Info: Camden, NJ.
Ship Ref: 327 N. Front St

	Pounds	Kilo
Gross	78,900	35,788
Tare	27,720 *	12,574
Net	51,180	23,215

25.59 Ton 23.21
* Predetermined Tare

	UNIT	TOTALS
Material:		
Freight:		
Tax:		
Fee / Fuel:		
Other Chrg: No		

Today Tons:	566.46	Loads:
Tons To Date:	7,246.35	22
Today Tonnes	513.88	
Tonnes To Date:	6,573.78	

Carrier : 3804135 MOD HAULING SERVICES
Vehicle: MOD105 MOD Hauling Services
License: AT496J
MaxGVW: 80,000

By acceptance of this ticket (with or without signature), driver accepts on behalf of themselves/their employer sole responsibility to ensure that the load received is within the weight limit authorized by law and shall hold seller harmless against any and all claims with respect to same CURB DELIVERY ONLY. NOT RESPONSIBLE FOR ANY DAMAGE BEYOND CURB.

Received: MOD
Weighmaster: Colleen LeSage

Cust: _____

P/D Status: Deliver

Customer Do Not Accept [2] Scale: 1



Plant: 32411

Berlin
368 New Brooklyn Road
Berlin, NJ 08009
856-809-0142

3/21/2017 12:14 In :
Customer: 8638404 THE AMBIENT GROUP LLC
Order : 950949 Camden, NJ. ABC Barrel Project
P.O. :

Tkt. No. 1006027632

Product 114203
Bank Run
S.O. Info: Camden, NJ.
Ship Ref: 327 N. Front St



	Pounds	Kilo
Gross	77,900	35,335
Tare	27,100 *	12,292
Net	50,800	23,042

25.40 Ton 23.04
* Predetermined Tare

UNIT	TOTALS
Material:	
Freight:	
Tax:	
Fee / Fuel:	
Other Chrg: No	

Today Tons:	591.86	Loads:
Tons To Date:	7,271.75	23
Today Tonnes	536.93	
Tonnes To Date:	6,596.82	

Carrier : 2347631 R A DIMARIA
Vehicle: DY026 DiMaria
License: AS200U
MaxGVW: 80,000
Received:
Weighmaster: Colleen LeSage

By acceptance of this ticket (with or without signature), driver accepts on behalf of themselves/their employer sole responsibility to ensure that the load received is within the weight limit authorized by law and shall hold seller harmless against any and all claims with respect to same CURB DELIVERY ONLY. NOT RESPONSIBLE FOR ANY DAMAGE BEYOND CURB.

Cust: _____

P/D Status: Deliver

Customer Do Not Accept [2] Scale: 1



Plant: 32411

Berlin
368 New Brooklyn Road
Berlin, NJ 08009
856-809-0142

3/21/2017 12:16 In :
Customer: 8638404 THE AMBIENT GROUP LLC
Order : 950949 Camden, NJ. ABC Barrel Project
P.O. :

Tkt. No. 1006027633

Product 114203
Bank Run
S.O. Info: Camden, NJ.
Ship Ref: 327 N. Front St



	Pounds	Kilo
Gross	77,960	35,362
Tare	28,240 *	12,809
Net	49,720	22,553

24.86 Ton 22.55
* Predetermined Tare

UNIT	TOTALS
Material:	
Freight:	
Tax:	
Fee / Fuel:	
Other Chrg: No	

Today Tons:	616.72	Loads:
Tons To Date:	7,296.61	24
Today Tonnes	559.48	
Tonnes To Date:	6,619.37	

Carrier : 8040648 GJ SCOTT LLC
Vehicle: GS16 GS16
License: AT639K
MaxGVW: 80,000
Received:
Weighmaster: Colleen LeSage

By acceptance of this ticket (with or without signature), driver accepts on behalf of themselves/their employer sole responsibility to ensure that the load received is within the weight limit authorized by law and shall hold seller harmless against any and all claims with respect to same CURB DELIVERY ONLY. NOT RESPONSIBLE FOR ANY DAMAGE BEYOND CURB.

Cust: _____

P/D Status: Deliver

Customer Do Not Accept [2] Scale: 1



Plant: 32411

Berlin
368 New Brooklyn Road
Berlin, NJ 08009
856-809-0142

3/21/2017 12:20 In :
Customer: 8638404 THE AMBIENT GROUP LLC
Order : 950949 Camden, NJ. ABC Barrel Project
P.O. :

Tkt. No. 1006027635



Product 114203
Bank Run
S.O. Info: Camden, NJ.
Ship Ref: 327 N. Front St

	Pounds	Kilo
Gross	76,440	34,673
Tare	24,780 *	11,240
Net	51,660	23,433

25.83 Ton 23.43

* Predetermined Tare

Today Tons:	642.55	Loads:
Tons To Date:	7,322.44	25
Today Tonnes	582.91	
Tonnes To Date:	6,642.81	

By acceptance of this ticket (with or without signature), driver accepts on behalf of themselves/their employer sole responsibility to ensure that the load received is within the weight limit authorized by law and shall hold seller harmless against any and all claims with respect to same CURB DELIVERY ONLY. NOT RESPONSIBLE FOR ANY DAMAGE BEYOND CURB.

UNIT	TOTALS
Material:	
Freight:	
Tax:	
Fee / Fuel:	
Other Chrg: <u>No</u>	

Carrier : 8515471 CALLE TRUCKING LLC
Vehicle: CALLE5 Calle Trucking
License: AF49921
MaxGVW: 80,000

Received: _____ Cust: _____

Weighmaster: Colleen LeSage

P/D Status: Deliver

Customer Do Not Accept [3] Scale: 1



Plant: 32411

Berlin
368 New Brooklyn Road
Berlin, NJ 08009
856-809-0142

3/21/2017 12:22 In :
Customer: 8638404 THE AMBIENT GROUP LLC
Order : 950949 Camden, NJ. ABC Barrel Project
P.O. :

Tkt. No. 1006027636



Product 114203
Bank Run
S.O. Info: Camden, NJ.
Ship Ref: 327 N. Front St

	Pounds	Kilo
Gross	76,820	34,845
Tare	27,120 *	12,301
Net	49,700	22,544

24.85 Ton 22.54

* Predetermined Tare

Today Tons:	667.40	Loads:
Tons To Date:	7,347.29	26
Today Tonnes	605.45	
Tonnes To Date:	6,665.35	

By acceptance of this ticket (with or without signature), driver accepts on behalf of themselves/their employer sole responsibility to ensure that the load received is within the weight limit authorized by law and shall hold seller harmless against any and all claims with respect to same CURB DELIVERY ONLY. NOT RESPONSIBLE FOR ANY DAMAGE BEYOND CURB.

UNIT	TOTALS
Material:	
Freight:	
Tax:	
Fee / Fuel:	
Other Chrg: <u>No</u>	

Carrier : 8040648 GJ SCOTT LLC
Vehicle: GS6 GS6
License: AK761C
MaxGVW: 80,000

Received: _____ Cust: _____

Weighmaster: Colleen LeSage

P/D Status: Deliver

Customer Do Not Accept [2] Scale: 1



Plant: 32411

Berlin
368 New Brooklyn Road
Berlin, NJ 08009
856-809-0142

3/21/2017 12:51 In :
Customer: 8638404 THE AMBIENT GROUP LLC
Order : 950949 Camden, NJ. ABC Barrel Project
P.O. :

Tkt. No. 1006027639



Product 114203
Bank Run
S.O. Info: Camden, NJ.
Ship Ref: 327 N. Front St

	Pounds	Kilo
Gross	79,060	35,861
Tare	26,640 *	12,084
Net	52,420	23,777

26.21 Ton 23.78

* Predetermined Tare

	UNIT	TOTALS
Material:		
Freight:		
Tax:		
Fee / Fuel:		
Other Chrg: No		

Today Tons:	693.61	Loads:
Tons To Date:	7,373.50	27
Today Tonnes	629.23	
Tonnes To Date:	6,689.13	

Carrier : 2347032 ROCKY LOGIOVINO TRUCKIN
Vehicle: LR060 Rocky
License: AM637B
MaxGVW: 80,000

By acceptance of this ticket (with or without signature), driver accepts on behalf of themselves/their employer sole responsibility to ensure that the load received is within the weight limit authorized by law and shall hold seller harmless against any and all claims with respect to same CURB DELIVERY ONLY. NOT RESPONSIBLE FOR ANY DAMAGE BEYOND CURB.

Received: _____ Cust: _____
Weighmaster: Colleen LeSage

P/D Status: Deliver

Customer Do Not Accept [2] Scale: 1



Plant: 32411

Berlin
368 New Brooklyn Road
Berlin, NJ 08009
856-809-0142

3/21/2017 13:42 In :
Customer: 8638404 THE AMBIENT GROUP LLC
Order : 950949 Camden, NJ. ABC Barrel Project
P.O. :

Tkt. No. 1006027647



Product 114203
Bank Run
S.O. Info: Camden, NJ.
Ship Ref: 327 N. Front St

	Pounds	Kilo
Gross	76,200	34,564
Tare	24,780 *	11,240
Net	51,420	23,324

25.71 Ton 23.32

* Predetermined Tare

	UNIT	TOTALS
Material:		
Freight:		
Tax:		
Fee / Fuel:		
Other Chrg: No		

Today Tons:	719.32	Loads:
Tons To Date:	7,399.21	28
Today Tonnes	652.56	
Tonnes To Date:	6,712.45	

Carrier : 8515471 CALLE TRUCKING LLC
Vehicle: CALLE5 Calle Trucking
License: AF49921
MaxGVW: 80,000

By acceptance of this ticket (with or without signature), driver accepts on behalf of themselves/their employer sole responsibility to ensure that the load received is within the weight limit authorized by law and shall hold seller harmless against any and all claims with respect to same CURB DELIVERY ONLY. NOT RESPONSIBLE FOR ANY DAMAGE BEYOND CURB.

Received: _____ Cust: _____
Weighmaster: Colleen LeSage

P/D Status: Deliver

Customer Do Not Accept [2] Scale: 1



Plant: 32411

Berlin

368 New Brooklyn Road
Berlin, NJ 08009
856-809-0142

3/21/2017 13:48

In :

Customer: 8638404 THE AMBIENT GROUP LLC

Order : 950949 Camden, NJ. ABC Barrel Project

P.O. :

Tkt. No. 1006027648

Product 114203

Bank Run

S.O. Info: Camden, NJ.

Ship Ref: 327 N. Front St



	Pounds	Kilo
Gross	78,680	35,689
Tare	28,240 *	12,809
Net	50,440	22,879

25.22 Ton 22.88

* Predetermined Tare

	UNIT	TOTALS
Material:		
Freight:		
Tax:		
Fee / Fuel:		
Other Chrg: No		

Today Tons:	744.54	Loads:
Tons To Date:	7,424.43	29
Today Tonnes	675.44	
Tonnes To Date:	6,735.33	

Carrier : 8040648 GJ SCOTT LLC

Vehicle: GS16 GS16

License: AT639K

MaxGVW: 80,000

Received: _____

Weighmaster: Colleen LeSage

Cust: _____

By acceptance of this ticket (with or without signature), driver accepts on behalf of themselves/their employer sole responsibility to ensure that the load received is within the weight limit authorized by law and shall hold seller harmless against any and all claims with respect to same CURB DELIVERY ONLY. NOT RESPONSIBLE FOR ANY DAMAGE BEYOND CURB.

P/D Status: Deliver

Customer Copy

Scale: 1



Plant: 32411

Berlin

368 New Brooklyn Road
Berlin, NJ 08009
856-809-0142

3/21/2017 13:52

In :

Customer: 8638404 THE AMBIENT GROUP LLC

Order : 950949 Camden, NJ. ABC Barrel Project

P.O. :

Tkt. No. 1006027649

Product 114203

Bank Run

S.O. Info: Camden, NJ.

Ship Ref: 327 N. Front St



	Pounds	Kilo
Gross	77,180	35,008
Tare	27,120 *	12,301
Net	50,060	22,707

25.03 Ton 22.71

* Predetermined Tare

	UNIT	TOTALS
Material:		
Freight:		
Tax:		
Fee / Fuel:		
Other Chrg: No		

Today Tons:	769.57	Loads:
Tons To Date:	7,449.46	30
Today Tonnes	698.14	
Tonnes To Date:	6,758.04	

Carrier : 8040648 GJ SCOTT LLC

Vehicle: GS6 GS6

License: AK761C

MaxGVW: 80,000

Received: _____

Weighmaster: Colleen LeSage

Cust: _____

By acceptance of this ticket (with or without signature), driver accepts on behalf of themselves/their employer sole responsibility to ensure that the load received is within the weight limit authorized by law and shall hold seller harmless against any and all claims with respect to same CURB DELIVERY ONLY. NOT RESPONSIBLE FOR ANY DAMAGE BEYOND CURB.

P/D Status: Deliver

Customer Do Not Accept [1]

Scale: 1



Plant: 32411

Berlin

368 New Brooklyn Road
Berlin, NJ 08009
856-809-0142

3/21/2017 13:54

In: 13:32:51

Customer: 8638404

THE AMBIENT GROUP LLC

Order: 950949

Camden, NJ. ABC Barrel Project

Tkt. No.

1006027650

P.O.:



Product 114203

Bank Run

S.O. Info: Camden, NJ.

Ship Ref: 327 N. Front St

	Pounds	Kilo
Gross	75,660	34,319
Tare	23,180	10,514
Net	52,480	23,805
	26.24 Ton	23.80

	UNIT	TOTALS
Material:		
Freight:		
Tax:		
Fee / Fuel:		
Other Chrg:	No	

Today Tons:	795.81	Loads:
Tons To Date:	7,475.70	31
Today Tonnes	721.95	
Tonnes To Date:	6,781.84	

Carrier : 8515471 CALLE TRUCKING LLC

Vehicle: CALLE9

AG07469

License: AG07469

MaxGVW: 80,000

Received: 

Weighmaster: Colleen LeSage

P/D Status: Deliver

By acceptance of this ticket (with or without signature), driver accepts on behalf of themselves/their employer sole responsibility to ensure that the load received is within the weight limit authorized by law and shall hold seller harmless against any and all claims with respect to same CURB DELIVERY ONLY. NOT RESPONSIBLE FOR ANY DAMAGE BEYOND CURB.

Cust: _____

Customer Copy

Scale: 1



Plant: 32411

Berlin

368 New Brooklyn Road
Berlin, NJ 08009
856-809-0142

3/22/2017 07:23

In: 6:45:09

Customer: 8638404 THE AMBIENT GROUP LLC

Order: 950949 Camden, NJ. ABC Barrel Project

P.O.:

Tkt. No. 1006027659

Product 114203

Bank Run

S.O. Info: Camden, NJ.

Ship Ref: 327 N. Front St



	Pounds	Kilo
Gross	77,380	35,099
Tare	28,120	12,755
Net	49,260	22,344

24.63 Ton 22.34

	UNIT	TOTALS
Material:		
Freight:		
Tax:		
Fee / Fuel:		
Other Chrg:	No	

Today Tons:	24.63	Loads:
Tons To Date:	7,500.33	1
Today Tonnes	22.34	
Tonnes To Date:	6,804.18	

Carrier: 8040648 GJ SCOTT LLC

Vehicle: GS16 GS16

License: AT639K

MaxGVW: 80,000

Received:

Weighmaster: Colleen LeSage

By acceptance of this ticket (with or without signature), driver accepts on behalf of themselves/their employer sole responsibility to ensure that the load received is within the weight limit authorized by law and shall hold seller harmless against any and all claims with respect to same CURB DELIVERY ONLY. NOT RESPONSIBLE FOR ANY DAMAGE BEYOND CURB.

Cust: _____

P/D Status: Deliver

Customer Copy

Scale: 1



Plant: 32411

Berlin

368 New Brooklyn Road
Berlin, NJ 08009
856-809-0142

3/22/2017 07:26

In: 6:45:29

Customer: 8638404 THE AMBIENT GROUP LLC

Order: 950949 Camden, NJ. ABC Barrel Project

P.O.:

Tkt. No. 1006027660

Product 114203

Bank Run

S.O. Info: Camden, NJ.

Ship Ref: 327 N. Front St



	Pounds	Kilo
Gross	76,700	34,791
Tare	27,040	12,265
Net	49,660	22,525

24.83 Ton 22.53

	UNIT	TOTALS
Material:		
Freight:		
Tax:		
Fee / Fuel:		
Other Chrg:	No	

Today Tons:	49.46	Loads:
Tons To Date:	7,525.16	2
Today Tonnes	44.87	
Tonnes To Date:	6,826.71	

Carrier: 8040648 GJ SCOTT LLC

Vehicle: GS6 GS6

License: AK761C

MaxGVW: 80,000

Received:

Weighmaster: Colleen LeSage

By acceptance of this ticket (with or without signature), driver accepts on behalf of themselves/their employer sole responsibility to ensure that the load received is within the weight limit authorized by law and shall hold seller harmless against any and all claims with respect to same CURB DELIVERY ONLY. NOT RESPONSIBLE FOR ANY DAMAGE BEYOND CURB.

Cust: _____

P/D Status: Deliver

Customer Copy

Scale: 1



Plant: 32411

Berlin

368 New Brooklyn Road
Berlin, NJ 08009
856-809-0142

3/22/2017 07:27 In: 6:44:28
Customer: 8638404 THE AMBIENT GROUP LLC
Order : 950949 Camden, NJ. ABC Barrel Project
P.O. :

Tkt. No. 1006027661

Product 114203
Bank Run
S.O. Info: Camden, NJ
Ship Ref: 327 N. Front St



	UNIT	TOTALS
Material:		
Freight:		
Tax:		
Fee / Fuel:		
Other Chrg: No		

	Pounds	Kilo
Gross	78,540	35,625
Tare	25,800	11,703
Net	52,740	23,922
	26.37 Ton	23.92

Today Tons:	75.83	Loads:	
Tons To Date:	7,551.53		3
Today Tonnes	68.79		
Tonnes To Date:	6,850.63		

Carrier : 8647386 TURKEYROOST TRANSPORT
Vehicle: TUR001 Turkeyroost
License: AP182A
MaxGVW: 80,000
Received: _____
Weighmaster: Colleen LeSage

By acceptance of this ticket (with or without signature), driver accepts on behalf of themselves/their employer sole responsibility to ensure that the load received is within the weight limit authorized by law and shall hold seller harmless against any and all claims with respect to same
CURB DELIVERY ONLY. NOT RESPONSIBLE FOR ANY DAMAGE BEYOND CURB.

Cust: _____

P/D Status: Deliver

Customer Do Not Accept [1] Scale: 1



Plant: 32411

Berlin

368 New Brooklyn Road
Berlin, NJ 08009
856-809-0142

3/22/2017 07:29 In: 6:47:47
Customer: 8638404 THE AMBIENT GROUP LLC
Order : 950949 Camden, NJ. ABC Barrel Project
P.O. :

Tkt. No. 1006027662

Product 114203
Bank Run
S.O. Info: Camden, NJ
Ship Ref: 327 N. Front St



	UNIT	TOTALS
Material:		
Freight:		
Tax:		
Fee / Fuel:		
Other Chrg: No		

	Pounds	Kilo
Gross	75,740	34,355
Tare	24,600	11,158
Net	51,140	23,197
	25.57 Ton	23.20

Today Tons:	101.40	Loads:	
Tons To Date:	7,577.10		4
Today Tonnes	91.99		
Tonnes To Date:	6,873.83		

Carrier : 2346970 GEORGE LAZOS TRUCKING
Vehicle: LG004 AP213T
License: LG004
MaxGVW: 80,000
Received: _____
Weighmaster: Colleen LeSage

By acceptance of this ticket (with or without signature), driver accepts on behalf of themselves/their employer sole responsibility to ensure that the load received is within the weight limit authorized by law and shall hold seller harmless against any and all claims with respect to same
CURB DELIVERY ONLY. NOT RESPONSIBLE FOR ANY DAMAGE BEYOND CURB.

Cust: _____

P/D Status: Deliver

Customer Copy Scale: 1



Plant: 32411

Berlin

368 New Brooklyn Road
Berlin, NJ 08009
856-809-0142

3/22/2017 07:31

In: 6:54:50

Customer: 8638404

THE AMBIENT GROUP LLC

Order : 950949

Camden, NJ. ABC Barrel Project

Tkt. No. 1006027663

P.O. :



Product 114203

Bank Run

S.O. Info: Camden, NJ.

Ship Ref: 327 N. Front St

	Pounds	Kilo
Gross	78,900	35,788
Tare	26,640	12,084
Net	52,260	23,705
	26.13 Ton	23.70

	UNIT	TOTALS
Material:		
Freight:		
Tax:		
Fee / Fuel:		
Other Chrg: No		

Today Tons:	127.53	Loads:
Tons To Date:	7,603.23	5
Today Tonnes	115.69	
Tonnes To Date:	6,897.53	

Carrier : 2347032 ROCKY LOGIOVINO TRUCKIN

Vehicle: LR060

Rocky

License: AM637B

MaxGVW: 80,000

Received: _____

Cust: _____

Weighmaster: Colleen LeSage

P/D Status: Deliver

By acceptance of this ticket (with or without signature), driver accepts on behalf of themselves/their employer sole responsibility to ensure that the load received is within the weight limit authorized by law and shall hold seller harmless against any and all claims with respect to same
CURB DELIVERY ONLY. NOT RESPONSIBLE FOR ANY DAMAGE BEYOND CURB.

Customer Do Not Accept [1] Scale: 1



Plant: 32411

Berlin

368 New Brooklyn Road
Berlin, NJ 08009
856-809-0142

3/22/2017 08:17

In: 6:27:10

Customer: 8638404

THE AMBIENT GROUP LLC

Order : 950949

Camden, NJ. ABC Barrel Project

Tkt. No. 1006027673

P.O. :



Product 114203

Bank Run

S.O. Info: Camden, NJ.

Ship Ref: 327 N. Front St

	Pounds	Kilo
Gross	77,600	35,199
Tare	25,020	11,349
Net	52,580	23,850
	26.29 Ton	23.85

	UNIT	TOTALS
Material:		
Freight:		
Tax:		
Fee / Fuel:		
Other Chrg: No		

Today Tons:	153.82	Loads:
Tons To Date:	7,629.52	6
Today Tonnes	139.54	
Tonnes To Date:	6,921.38	

Carrier : 8540415 S CUMMINS LLC

Vehicle: CUM17

Steve

License: AT979F

MaxGVW: 80,000

Received: _____

Cust: _____

Weighmaster: Colleen LeSage

P/D Status: Deliver

By acceptance of this ticket (with or without signature), driver accepts on behalf of themselves/their employer sole responsibility to ensure that the load received is within the weight limit authorized by law and shall hold seller harmless against any and all claims with respect to same
CURB DELIVERY ONLY. NOT RESPONSIBLE FOR ANY DAMAGE BEYOND CURB.

Customer Copy Scale: 1



Plant: 32411

Berlin

368 New Brooklyn Road
Berlin, NJ 08009
856-809-0142

3/22/2017 08:41 In: 7:40:13
Customer: 8638404 THE AMBIENT GROUP LLC
Order : 950949 Camden, NJ. ABC Barrel Project
P.O. :

Tkt. No. 1006027674

Product 114203
Bank Run
S.O. Info: Camden, NJ.
Ship Ref: 327 N. Front St



	Pounds	Kilo
Gross	76,180	34,555
Tare	25,320	11,485
Net	50,860	23,070
	25.43 Ton	23.07

	UNIT	TOTALS
Material:		
Freight:		
Tax:		
Fee / Fuel:		
Other Chrg:	No	

Today Tons:	179.25	Loads:
Tons To Date:	7,654.95	7
Today Tonnes	162.61	
Tonnes To Date:	6,944.45	

Carrier : 2347198 RAIO CONTRACTING & MATE
Vehicle: RO207 AT303G
License: AT303G
MaxGVW: 80,000
Received: _____
Weighmaster: Colleen LeSage

By acceptance of this ticket (with or without signature), driver accepts on behalf of themselves/their employer sole responsibility to ensure that the load received is within the weight limit authorized by law and shall hold seller harmless against any and all claims with respect to same CURB DELIVERY ONLY. NOT RESPONSIBLE FOR ANY DAMAGE BEYOND CURB.

Cust: _____

P/D Status: Deliver

Customer Copy

Scale: 1



Plant: 32411

Berlin

368 New Brooklyn Road
Berlin, NJ 08009
856-809-0142

3/22/2017 08:42 In: 7:40:23
Customer: 8638404 THE AMBIENT GROUP LLC
Order : 950949 Camden, NJ. ABC Barrel Project
P.O. :

Tkt. No. 1006027675

Product 114203
Bank Run
S.O. Info: Camden, NJ.
Ship Ref: 327 N. Front St



	Pounds	Kilo
Gross	77,040	34,945
Tare	25,020	11,349
Net	52,020	23,596
	26.01 Ton	23.60

	UNIT	TOTALS
Material:		
Freight:		
Tax:		
Fee / Fuel:		
Other Chrg:	No	

Today Tons:	205.26	Loads:
Tons To Date:	7,680.96	8
Today Tonnes	186.21	
Tonnes To Date:	6,968.05	

Carrier : 2347198 RAIO CONTRACTING & MATE
Vehicle: RO222 AK269E
License: AK269e
MaxGVW: 80,000
Received: _____
Weighmaster: Colleen LeSage

By acceptance of this ticket (with or without signature), driver accepts on behalf of themselves/their employer sole responsibility to ensure that the load received is within the weight limit authorized by law and shall hold seller harmless against any and all claims with respect to same CURB DELIVERY ONLY. NOT RESPONSIBLE FOR ANY DAMAGE BEYOND CURB.

Cust: _____

P/D Status: Deliver

Customer Copy

Scale: 1



Plant: 32411

Berlin

368 New Brooklyn Road
Berlin, NJ 08009
856-809-0142

3/22/2017 08:49 In: 8:37:38
Customer: 8638404 THE AMBIENT GROUP LLC
Order: 950949 Camden, NJ. ABC Barrel Project
P.O.:

Tkt. No. 1006027676



Product 114203
Bank Run
S.O. Info: Camden, NJ.
Ship Ref: 327 N. Front St

	Pounds	Kilo
Gross	75,700	34,337
Tare	24,440	11,086
Net	51,260	23,251
	25.63 Ton	23.25

	UNIT	TOTALS
Material:		
Freight:		
Tax:		
Fee / Fuel:		
Other Chrg: No		

Today Tons:	230.89	Loads:
Tons To Date:	7,706.59	9
Today Tonnes	209.46	
Tonnes To Date:	6,991.30	

Carrier: 2347198 RAIO CONTRACTING & MATE
Vehicle: RO217 AH178X
License:
MaxGVW: 80,000
Received: _____
Weighmaster: Colleen LeSage

By acceptance of this ticket (with or without signature), driver accepts on behalf of themselves/their employer sole responsibility to ensure that the load received is within the weight limit authorized by law and shall hold seller harmless against any and all claims with respect to same CURB DELIVERY ONLY. NOT RESPONSIBLE FOR ANY DAMAGE BEYOND CURB.

Cust: _____

P/D Status: Deliver

Customer Copy

Scale: 1



Plant: 32411

Berlin

368 New Brooklyn Road
Berlin, NJ 08009
856-809-0142

3/22/2017 09:13 In:
Customer: 8638404 THE AMBIENT GROUP LLC
Order: 950949 Camden, NJ. ABC Barrel Project
P.O.:

Tkt. No. 1006027683



Product 114203
Bank Run
S.O. Info: Camden, NJ.
Ship Ref: 327 N. Front St

	Pounds	Kilo
Gross	77,740	35,262
Tare	28,120 *	12,755
Net	49,620	22,507
	24.81 Ton	22.51

* Predetermined Tare

	UNIT	TOTALS
Material:		
Freight:		
Tax:		
Fee / Fuel:		
Other Chrg: No		

Today Tons:	255.70	Loads:
Tons To Date:	7,731.40	10
Today Tonnes	231.97	
Tonnes To Date:	7,013.81	

Carrier: 8040648 GJ SCOTT LLC
Vehicle: GS16 GS16
License: AT639K
MaxGVW: 80,000
Received: _____
Weighmaster: Colleen LeSage

By acceptance of this ticket (with or without signature), driver accepts on behalf of themselves/their employer sole responsibility to ensure that the load received is within the weight limit authorized by law and shall hold seller harmless against any and all claims with respect to same CURB DELIVERY ONLY. NOT RESPONSIBLE FOR ANY DAMAGE BEYOND CURB.

Cust: _____

P/D Status: Deliver

Customer Copy

Scale: 1



Plant: 32411

Berlin

368 New Brooklyn Road
Berlin, NJ 08009
856-809-0142

3/22/2017 09:17

In :

Customer: 8638404 THE AMBIENT GROUP LLC

Order : 950949 Camden, NJ. ABC Barrel Project

P.O. :

Tkt. No. 1006027684

Product 114203



Bank Run

S.O. Info: Camden, NJ.

Ship Ref: 327 N. Front St

	Pounds	Kilo
Gross	77,520	35,162
Tare	27,040 *	12,265
Net	50,480	22,897

25.24 Ton 22.90

* Predetermined Tare

	UNIT	TOTALS
Material:		
Freight:		
Tax:		
Fee / Fuel:		
Other Chrg: No		

Today Tons:	280.94	Loads:
Tons To Date:	7,756.64	11
Today Tonnes	254.86	
Tonnes To Date:	7,036.71	

Carrier : 8040648 GJ SCOTT LLC

Vehicle: GS6 GS6

License: AK761C

MaxGVW: 80,000

Received: 

Cust: _____

Weighmaster: Colleen LeSage

P/D Status: Deliver

By acceptance of this ticket (with or without signature), driver accepts on behalf of themselves/their employer sole responsibility to ensure that the load received is within the weight limit authorized by law and shall hold seller harmless against any and all claims with respect to same
CURB DELIVERY ONLY. NOT RESPONSIBLE FOR ANY DAMAGE BEYOND CURB.

Customer Do Not Accept [1] Scale: 1



Plant: 32411

Berlin

368 New Brooklyn Road
Berlin, NJ 08009
856-809-0142

3/22/2017 09:19

In :

Customer: 8638404 THE AMBIENT GROUP LLC

Order : 950949 Camden, NJ. ABC Barrel Project

P.O. :

Tkt. No. 1006027685

Product 114203



Bank Run

S.O. Info: Camden, NJ.

Ship Ref: 327 N. Front St

	Pounds	Kilo
Gross	78,840	35,761
Tare	26,640 *	12,084
Net	52,200	23,678

26.10 Ton 23.68

* Predetermined Tare

	UNIT	TOTALS
Material:		
Freight:		
Tax:		
Fee / Fuel:		
Other Chrg: No		

Today Tons:	307.04	Loads:
Tons To Date:	7,782.74	12
Today Tonnes	278.54	
Tonnes To Date:	7,060.38	

Carrier : 2347032 ROCKY LOGIOVINO TRUCKIN

Vehicle: LR060 Rocky

License: AM637B

MaxGVW: 80,000

Received: _____

Cust: _____

Weighmaster: Colleen LeSage

P/D Status: Deliver

By acceptance of this ticket (with or without signature), driver accepts on behalf of themselves/their employer sole responsibility to ensure that the load received is within the weight limit authorized by law and shall hold seller harmless against any and all claims with respect to same
CURB DELIVERY ONLY. NOT RESPONSIBLE FOR ANY DAMAGE BEYOND CURB.

Customer Copy Scale: 1



Plant: 32411

Berlin

368 New Brooklyn Road
Berlin, NJ 08009
856-809-0142

3/22/2017 09:22

In :

Customer: 8638404 THE AMBIENT GROUP LLC

Order : 950949 Camden, NJ. ABC Barrel Project

P.O. :

Tkt. No. 1006027686

Product 114203

Bank Run

S.O. Info: Camden, NJ.

Ship Ref: 327 N. Front St



	Pounds	Kilo
Gross	76,920	34,890
Tare	24,600 *	11,158
Net	52,320	23,732

26.16 Ton 23.73

* Predetermined Tare

Today Tons:	333.20	Loads:
Tons To Date:	7,808.90	13
Today Tonnes	302.27	
Tonnes To Date:	7,084.11	

	UNIT	TOTALS
Material:		
Freight:		
Tax:		
Fee / Fuel:		
Other Chrg:	No	

Carrier : 2346970 GEORGE LAZOS TRUCKING

Vehicle: LG004 AP213T

License: LG004

MaxGVW: 80,000

Received: _____

Cust: _____

Weighmaster: Colleen LeSage

P/D Status: Deliver

Customer Copy

Scale: 1

By acceptance of this ticket (with or without signature), driver accepts on behalf of themselves/their employer sole responsibility to ensure that the load received is within the weight limit authorized by law and shall holdseller harmless against any and all claims with respect to same CURB DELIVERY ONLY. NOT RESPONSIBLE FOR ANY DAMAGE BEYOND CURB.



Plant: 32411

Berlin

368 New Brooklyn Road
Berlin, NJ 08009
856-809-0142

3/22/2017 09:27

In :

Customer: 8638404 THE AMBIENT GROUP LLC

Order : 950949 Camden, NJ. ABC Barrel Project

P.O. :

Tkt. No. 1006027688

Product 114203

Bank Run

S.O. Info: Camden, NJ.

Ship Ref: 327 N. Front St



	Pounds	Kilo
Gross	79,840	36,215
Tare	25,800 *	11,703
Net	54,040	24,512

27.02 Ton 24.51

* Predetermined Tare

Today Tons:	360.22	Loads:
Tons To Date:	7,835.92	14
Today Tonnes	326.79	
Tonnes To Date:	7,108.63	

	UNIT	TOTALS
Material:		
Freight:		
Tax:		
Fee / Fuel:		
Other Chrg:	No	

Carrier : 8647386 TURKEYROOST TRANSPORT

Vehicle: TUR001 Turkeyroost

License: AP182A

MaxGVW: 80,000

Received: _____

Cust: _____

Weighmaster: Colleen LeSage

P/D Status: Deliver

Customer Copy

Scale: 1

By acceptance of this ticket (with or without signature), driver accepts on behalf of themselves/their employer sole responsibility to ensure that the load received is within the weight limit authorized by law and shall holdseller harmless against any and all claims with respect to same CURB DELIVERY ONLY. NOT RESPONSIBLE FOR ANY DAMAGE BEYOND CURB.



Plant: 32411

Berlin

368 New Brooklyn Road
Berlin, NJ 08009
856-809-0142

3/22/2017 09:49

In:

Customer: 8638404 THE AMBIENT GROUP LLC

Order : 950949 Camden, NJ. ABC Barrel Project

P.O. :

Tkt. No. 1006027690

Product 114203

Bank Run

S.O. Info: Camden, NJ.

Ship Ref: 327 N. Front St



	Pounds	Kilo
Gross	78,240	35,489
Tare	25,020 *	11,349
Net	53,220	24,140

26.61 Ton 24.14

* Predetermined Tare

	UNIT	TOTALS
Material:		
Freight:		
Tax:		
Fee / Fuel:		
Other Chrg: No		

Today Tons:	386.83	Loads:
Tons To Date:	7,862.53	15
Today Tonnes	350.93	
Tonnes To Date:	7,132.77	

Carrier : 8540415 S CUMMINS LLC

Vehicle: CUM17 Steve

License: AT979F

MaxGVW: 80,000

Received:

Weighmaster: Colleen LeSage

By acceptance of this ticket (with or without signature), driver accepts on behalf of themselves/their employer sole responsibility to ensure that the load received is within the weight limit authorized by law and shall holdseller harmless against any and all claims with respect to same CURB DELIVERY ONLY. NOT RESPONSIBLE FOR ANY DAMAGE BEYOND CURB.

Cust: _____

P/D Status: Deliver

Customer Copy

Scale: 1



Plant: 32411

Berlin

368 New Brooklyn Road
Berlin, NJ 08009
856-809-0142

3/22/2017 10:41

In:

Customer: 8638404 THE AMBIENT GROUP LLC

Order : 950949 Camden, NJ. ABC Barrel Project

P.O. :

Tkt. No. 1006027696

Product 114203

Bank Run

S.O. Info: Camden, NJ.

Ship Ref: 327 N. Front St



	Pounds	Kilo
Gross	78,060	35,407
Tare	28,120 *	12,755
Net	49,940	22,652

24.97 Ton 22.65

* Predetermined Tare

	UNIT	TOTALS
Material:		
Freight:		
Tax:		
Fee / Fuel:		
Other Chrg: No		

Today Tons:	411.80	Loads:
Tons To Date:	7,887.50	16
Today Tonnes	373.58	
Tonnes To Date:	7,155.42	

Carrier : 8040648 GJ SCOTT LLC

Vehicle: GS16 GS16

License: AT639K

MaxGVW: 80,000

Received:

Weighmaster: Colleen LeSage

By acceptance of this ticket (with or without signature), driver accepts on behalf of themselves/their employer sole responsibility to ensure that the load received is within the weight limit authorized by law and shall holdseller harmless against any and all claims with respect to same CURB DELIVERY ONLY. NOT RESPONSIBLE FOR ANY DAMAGE BEYOND CURB.

Cust: _____

P/D Status: Deliver

Customer Copy

Scale: 1



Plant: 32411

Berlin

368 New Brooklyn Road
Berlin, NJ 08009
856-809-0142

3/22/2017 10:45

In:

Customer: 8638404 THE AMBIENT GROUP LLC

Order : 950949 Camden, NJ. ABC Barrel Project

P.O. :

Tkt. No. 1006027697

Product 114203

Bank Run

S.O. Info: Camden, NJ.

Ship Ref: 327 N. Front St



	Pounds	Kilo
Gross	76,180	34,555
Tare	27,040 *	12,265
Net	49,140	22,290

24.57 Ton 22.29

* Predetermined Tare

	UNIT	TOTALS
Material:		
Freight:		
Tax:		
Fee / Fuel:		
Other Chrg:	No	

Today Tons:	436.37	Loads:
Tons To Date:	7,912.07	17
Today Tonnes	395.87	
Tonnes To Date:	7,177.71	

Carrier : 8040648 GJ SCOTT LLC

Vehicle: GS6 GS6

License: AK761C

MaxGVW: 80,000

By acceptance of this ticket (with or without signature), driver accepts on behalf of themselves/their employer sole responsibility to ensure that the load received is within the weight limit authorized by law and shall hold seller harmless against any and all claims with respect to same CURB DELIVERY ONLY. NOT RESPONSIBLE FOR ANY DAMAGE BEYOND CURB.

Received: _____

Cust: _____

Weighmaster: Colleen LeSage

P/D Status: Deliver

Customer Copy

Scale: 1



Plant: 32411

Berlin

368 New Brooklyn Road
Berlin, NJ 08009
856-809-0142

3/22/2017 10:47

In:

Customer: 8638404 THE AMBIENT GROUP LLC

Order : 950949 Camden, NJ. ABC Barrel Project

P.O. :

Tkt. No. 1006027698

Product 114203

Bank Run

S.O. Info: Camden, NJ.

Ship Ref: 327 N. Front St



	Pounds	Kilo
Gross	75,000	34,019
Tare	24,600 *	11,158
Net	50,400	22,861

25.20 Ton 22.86

* Predetermined Tare

	UNIT	TOTALS
Material:		
Freight:		
Tax:		
Fee / Fuel:		
Other Chrg:	No	

Today Tons:	461.57	Loads:
Tons To Date:	7,937.27	18
Today Tonnes	418.73	
Tonnes To Date:	7,200.57	

Carrier : 2346970 GEORGE LAZOS TRUCKING

Vehicle: LG004 AP213T

License: LG004

MaxGVW: 80,000

By acceptance of this ticket (with or without signature), driver accepts on behalf of themselves/their employer sole responsibility to ensure that the load received is within the weight limit authorized by law and shall hold seller harmless against any and all claims with respect to same CURB DELIVERY ONLY. NOT RESPONSIBLE FOR ANY DAMAGE BEYOND CURB.

Received: _____

Cust: _____

Weighmaster: Colleen LeSage

P/D Status: Deliver

Customer Copy

Scale: 1



Plant: 32411

Berlin

368 New Brooklyn Road
Berlin, NJ 08009
856-809-0142

3/22/2017 10:51 In:
Customer: 8638404 THE AMBIENT GROUP LLC
Order : 950949 Camden, NJ. ABC Barrel Project
P.O. :

Tkt. No. 1006027699



Product 114203
Bank Run
S.O. Info: Camden, NJ.
Ship Ref: 327 N. Front St

	Pounds	Kilo
Gross	79,740	36,169
Tare	26,640 *	12,084
Net	53,100	24,086

26.55 Ton 24.09
* Predetermined Tare

	UNIT	TOTALS
Material:		
Freight:		
Tax:		
Fee / Fuel:		
Other Chrg: No		

Today Tons:	488.12	Loads:
Tons To Date:	7,963.82	19
Today Tonnes	442.81	
Tonnes To Date:	7,224.66	

Carrier : 2347032 ROCKY LOGIOVINO TRUCKIN
Vehicle: LR060 Rocky
License: AM637B
MaxGVW: 80,000

By acceptance of this ticket (with or without signature), driver accepts on behalf of themselves/their employer sole responsibility to ensure that the load received is within the weight limit authorized by law and shall hold seller harmless against any and all claims with respect to same CURB DELIVERY ONLY. NOT RESPONSIBLE FOR ANY DAMAGE BEYOND CURB.

Received: _____
Weighmaster: Colleen LeSage

Cust: _____

P/D Status: Deliver

Customer Copy

Scale: 1



Plant: 32411

Berlin

368 New Brooklyn Road
Berlin, NJ 08009
856-809-0142

3/22/2017 10:53 In:
Customer: 8638404 THE AMBIENT GROUP LLC
Order : 950949 Camden, NJ. ABC Barrel Project
P.O. :

Tkt. No. 1006027700



Product 114203
Bank Run
S.O. Info: Camden, NJ.
Ship Ref: 327 N. Front St

	Pounds	Kilo
Gross	79,020	35,843
Tare	25,800 *	11,703
Net	53,220	24,140

26.61 Ton 24.14
* Predetermined Tare

	UNIT	TOTALS
Material:		
Freight:		
Tax:		
Fee / Fuel:		
Other Chrg: No		

Today Tons:	514.73	Loads:
Tons To Date:	7,990.43	20
Today Tonnes	466.96	
Tonnes To Date:	7,248.80	

Carrier : 8647386 TURKEYROOST TRANSPORT
Vehicle: TUR001 Turkeyroost
License: AP182A
MaxGVW: 80,000

By acceptance of this ticket (with or without signature), driver accepts on behalf of themselves/their employer sole responsibility to ensure that the load received is within the weight limit authorized by law and shall hold seller harmless against any and all claims with respect to same CURB DELIVERY ONLY. NOT RESPONSIBLE FOR ANY DAMAGE BEYOND CURB.

Received: _____
Weighmaster: Colleen LeSage

Cust: _____

P/D Status: Deliver

Customer Do Not Accept [1]

Scale: 1



Plant: 32411

Berlin

368 New Brooklyn Road
Berlin, NJ 08009
856-809-0142

3/22/2017 11:39 In: 11:21:29
Customer: 8638404 THE AMBIENT GROUP LLC
Order : 950949 Camden, NJ. ABC Barrel Project
P.O. :

Tkt. No. 1006027705

Product 114203
Bank Run
S.O. Info: Camden, NJ.
Ship Ref: 327 N. Front St



	Pounds	Kilo
Gross	78,000	35,380
Tare	27,320 *	12,392
Net	50,680	22,988

25.34 Ton 22.99
* Predetermined Tare

	UNIT	TOTALS
Material:		
Freight:		
Tax:		
Fee / Fuel:		
Other Chrg: No		

Today Tons:	540.07	Loads:
Tons To Date:	8,015.77	21
Today Tonnes	489.94	
Tonnes To Date:	7,271.78	

Carrier : 3804135 MOD HAULING SERVICES
Vehicle: MOD105 MOD Hauling Services
License: AT496J
MaxGVW: 80,000
Received: [Signature]
Weighmaster: Colleen LeSage

By acceptance of this ticket (with or without signature), driver accepts on behalf of themselves/their employer sole responsibility to ensure that the load received is within the weight limit authorized by law and shall hold seller harmless against any and all claims with respect to same CURB DELIVERY ONLY. NOT RESPONSIBLE FOR ANY DAMAGE BEYOND CURB.

Cust: _____

P/D Status: Deliver

Customer Copy

Scale: 1



Plant: 32411

Berlin

368 New Brooklyn Road
Berlin, NJ 08009
856-809-0142

3/22/2017 12:07 In:
Customer: 8638404 THE AMBIENT GROUP LLC
Order : 950949 Camden, NJ. ABC Barrel Project
P.O. :

Tkt. No. 1006027708

Product 114203
Bank Run
S.O. Info: Camden, NJ.
Ship Ref: 327 N. Front St

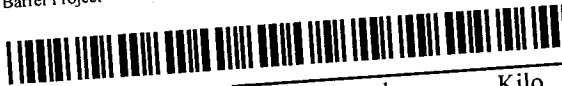

	Pounds	Kilo
Gross	78,420	35,571
Tare	28,120 *	12,755
Net	50,300	22,816

25.15 Ton 22.82
* Predetermined Tare

	UNIT	TOTALS
Material:		
Freight:		
Tax:		
Fee / Fuel:		
Other Chrg: No		

Today Tons:	565.22	Loads:
Tons To Date:	8,040.92	22
Today Tonnes	512.76	
Tonnes To Date:	7,294.60	

By acceptance of this ticket (with or without signature), driver accepts on behalf of themselves/their employer sole responsibility to ensure that the load received is within the weight limit authorized by law and shall hold seller harmless against any and all claims with respect to same CURB DELIVERY ONLY. NOT RESPONSIBLE FOR ANY DAMAGE BEYOND CURB.

Carrier : 8040648 GJ SCOTT LLC
Vehicle: GS16 GS16
License: AT639K
MaxGVW: 80,000
Received: [Signature]
Weighmaster: Colleen LeSage

Cust: _____

P/D Status: Deliver

Customer Copy

Scale: 1



Plant: 32411

Berlin

368 New Brooklyn Road
Berlin, NJ 08009
856-809-0142

3/22/2017 12:13 In:
Customer: 8638404 THE AMBIENT GROUP LLC
Order : 950949 Camden, NJ. ABC Barrel Project
P.O. :

Tkt. No. 1006027709



Product 114203
Bank Run
S.O. Info: Camden, NJ.
Ship Ref: 327 N. Front St

	Pounds	Kilo
Gross	77,320	35,072
Tare	27,040 *	12,265
Net	50,280	22,807

25.14 Ton 22.81

* Predetermined Tare

	UNIT	TOTALS
Material:		
Freight:		
Tax:		
Fee / Fuel:		
Other Chrg: No		

Today Tons:	590.36	Loads:
Tons To Date:	8,066.06	23
Today Tonnes	535.57	
Tonnes To Date:	7,317.41	

By acceptance of this ticket (with or without signature), driver accepts on behalf of themselves/their employer sole responsibility to ensure that the load received is within the weight limit authorized by law and shall hold seller harmless against any and all claims with respect to same CURB DELIVERY ONLY. NOT RESPONSIBLE FOR ANY DAMAGE BEYOND CURB.

Carrier : 8040648 GJ SCOTT LLC

Vehicle: GS6 GS6

License: AK761C

MaxGVW: 80,000

Received: 

Cust: _____

Weighmaster: Colleen LeSage

P/D Status: Deliver

Customer Copy

Scale: 1



Plant: 32411

Berlin

368 New Brooklyn Road
Berlin, NJ 08009
856-809-0142

3/22/2017 12:14 In:
Customer: 8638404 THE AMBIENT GROUP LLC
Order : 950949 Camden, NJ. ABC Barrel Project
P.O. :

Tkt. No. 1006027710



Product 114203
Bank Run
S.O. Info: Camden, NJ.
Ship Ref: 327 N. Front St

	Pounds	Kilo
Gross	77,700	35,244
Tare	24,600 *	11,158
Net	53,100	24,086

26.55 Ton 24.09

* Predetermined Tare

	UNIT	TOTALS
Material:		
Freight:		
Tax:		
Fee / Fuel:		
Other Chrg: No		

Today Tons:	616.91	Loads:
Tons To Date:	8,092.61	24
Today Tonnes	559.65	
Tonnes To Date:	7,341.49	

By acceptance of this ticket (with or without signature), driver accepts on behalf of themselves/their employer sole responsibility to ensure that the load received is within the weight limit authorized by law and shall hold seller harmless against any and all claims with respect to same CURB DELIVERY ONLY. NOT RESPONSIBLE FOR ANY DAMAGE BEYOND CURB.

Carrier : 2346970 GEORGE LAZOS TRUCKING

Vehicle: LG004 AP213T

License: LG004

MaxGVW: 80,000

Received: _____

Cust: _____

Weighmaster: Colleen LeSage

P/D Status: Deliver

Customer Copy

Scale: 1



Plant: 32411

Berlin

368 New Brooklyn Road
Berlin, NJ 08009
856-809-0142

3/22/2017 12:16

In: 11:50:37

Customer: 8638404

THE AMBIENT GROUP LLC

Order : 950949

Camden, NJ. ABC Barrel Project

Tkt. No. 1006027711

P.O. :



Product 114203

Bank Run

S.O. Info: Camden, NJ.

Ship Ref: 327 N. Front St

	Pounds	Kilo
Gross	75,780	34,373
Tare	24,640	11,177
Net	51,140	23,197
	25.57 Ton	23.20

	UNIT	TOTALS
Material:		
Freight:		
Tax:		
Fee / Fuel:		
Other Chrg: No		

Today Tons:	642.48	Loads:
Tons To Date:	8,118.18	25
Today Tonnes	582.85	
Tonnes To Date:	7,364.69	

Carrier : 2347198 RAIO CONTRACTING & MATE

Vehicle: RO219

AJ734F

License: RO219

MaxGVW: 80,000

Received: _____

MoE

Cust: _____

Weighmaster: Colleen LeSage

P/D Status: **Deliver**

By acceptance of this ticket (with or without signature), driver accepts on behalf of themselves/their employer sole responsibility to ensure that the load received is within the weight limit authorized by law and shall hold seller harmless against any and all claims with respect to same CURB DELIVERY ONLY. NOT RESPONSIBLE FOR ANY DAMAGE BEYOND CURB.

Customer Do Not Accept [1] Scale: 1



Plant: 32411

Berlin

368 New Brooklyn Road
Berlin, NJ 08009
856-809-0142

3/22/2017 12:18

In: 11:51:11

Customer: 8638404

THE AMBIENT GROUP LLC

Order : 950949

Camden, NJ. ABC Barrel Project

Tkt. No. 1006027712

P.O. :



Product 114203

Bank Run

S.O. Info: Camden, NJ.

Ship Ref: 327 N. Front St

	Pounds	Kilo
Gross	78,100	35,426
Tare	26,560	12,047
Net	51,540	23,378
	25.77 Ton	23.38

	UNIT	TOTALS
Material:		
Freight:		
Tax:		
Fee / Fuel:		
Other Chrg: No		

Today Tons:	668.25	Loads:
Tons To Date:	8,143.95	26
Today Tonnes	606.23	
Tonnes To Date:	7,388.07	

Carrier : 2347198 RAIO CONTRACTING & MATE

Vehicle: RO215

AH264S

License: AH264S

MaxGVW: 80,000

Received: _____

Cust: _____

Weighmaster: Colleen LeSage

P/D Status: **Deliver**

By acceptance of this ticket (with or without signature), driver accepts on behalf of themselves/their employer sole responsibility to ensure that the load received is within the weight limit authorized by law and shall hold seller harmless against any and all claims with respect to same CURB DELIVERY ONLY. NOT RESPONSIBLE FOR ANY DAMAGE BEYOND CURB.

Customer Do Not Accept [1] Scale: 1



Plant: 32411

Berlin
368 New Brooklyn Road
Berlin, NJ 08009
856-809-0142

3/22/2017 12:21 In :
Customer: 8638404 THE AMBIENT GROUP LLC
Order : 950949 Camden, NJ. ABC Barrel Project
P.O. :

Tkt. No. 1006027713

Product 114203
Bank Run
S.O. Info: Camden, NJ.
Ship Ref: 327 N. Front St



	Pounds	Kilo
Gross	78,720	35,707
Tare	26,640 *	12,084
Net	52,080	23,623

26.04 Ton 23.62
* Predetermined Tare

	UNIT	TOTALS
Material:		
Freight:		
Tax:		
Fee / Fuel:		
Other Chrg: No		

Today Tons:	694.29	Loads:
Tons To Date:	8,169.99	27
Today Tonnes	629.85	
Tonnes To Date:	7,411.69	

Carrier : 2347032 ROCKY LOGIOVINO TRUCKIN
Vehicle: LR060 Rocky
License: AM637B
MaxGVW: 80,000
Received: _____
Weighmaster: Colleen LeSage

By acceptance of this ticket (with or without signature), driver accepts on behalf of themselves/their employer sole responsibility to ensure that the load received is within the weight limit authorized by law and shall hold seller harmless against any and all claims with respect to same
CURB DELIVERY ONLY. NOT RESPONSIBLE FOR ANY DAMAGE BEYOND CURB.

Cust: _____

P/D Status: Deliver

Customer Do Not Accept [1] Scale: 1



Plant: 32411

Berlin
368 New Brooklyn Road
Berlin, NJ 08009
856-809-0142

3/22/2017 12:26 In :
Customer: 8638404 THE AMBIENT GROUP LLC
Order : 950949 Camden, NJ. ABC Barrel Project
P.O. :

Tkt. No. 1006027714

Product 114203
Bank Run
S.O. Info: Camden, NJ.
Ship Ref: 327 N. Front St



	Pounds	Kilo
Gross	79,300	35,970
Tare	25,800 *	11,703
Net	53,500	24,267

26.75 Ton 24.27
* Predetermined Tare

	UNIT	TOTALS
Material:		
Freight:		
Tax:		
Fee / Fuel:		
Other Chrg: No		

Today Tons:	721.04	Loads:
Tons To Date:	8,196.74	28
Today Tonnes	654.12	
Tonnes To Date:	7,435.96	

Carrier : 8647386 TURKEYROOST TRANSPORT
Vehicle: TUR001 Turkeyroost
License: AP182A
MaxGVW: 80,000
Received: _____
Weighmaster: Colleen LeSage

By acceptance of this ticket (with or without signature), driver accepts on behalf of themselves/their employer sole responsibility to ensure that the load received is within the weight limit authorized by law and shall hold seller harmless against any and all claims with respect to same
CURB DELIVERY ONLY. NOT RESPONSIBLE FOR ANY DAMAGE BEYOND CURB.

Cust: _____

P/D Status: Deliver

Customer Do Not Accept [1] Scale: 1



Plant: 32411

Berlin

368 New Brooklyn Road

Berlin, NJ 08009

856-809-0142

3/22/2017 13:13

In :

Customer: 8638404

THE AMBIENT GROUP LLC

Order : 950949

Camden, NJ. ABC Barrel Project

Tkt. No.

1006027722

P.O. :

Product 114203

Bank Run

S.O. Info: Camden, NJ.

Ship Ref: 327 N. Front St



	Pounds	Kilo
Gross	72,580	32,922
Tare	25,320 *	11,485
Net	47,260	21,437

23.63 Ton 21.44

* Predetermined Tare

Today Tons:	744.67	Loads:
Tons To Date:	8,220.37	29
Today Tonnes	675.55	
Tonnes To Date:	7,457.39	

	UNIT	TOTALS
Material:		
Freight:		
Tax:		
Fee / Fuel:		
Other Chrg: No		2207

By acceptance of this ticket (with or without signature), driver accepts on behalf of themselves/their employer sole responsibility to ensure that the load received is within the weight limit authorized by law and shall hold seller harmless against any and all claims with respect to same CURB DELIVERY ONLY. NOT RESPONSIBLE FOR ANY DAMAGE BEYOND CURB.

Carrier : 2347198 RAIO CONTRACTING & MATE

Vehicle: RO207

AT303G

License: AT303G

MaxGVW: 80,000

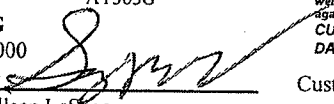
Received:  Cust: _____

Weighmaster: Colleen LeSage

P/D Status: Deliver

HANSON COPY

Scale: 1



Plant: 32411

Berlin

368 New Brooklyn Road

Berlin, NJ 08009

856-809-0142

3/22/2017 13:52

In :

Customer: 8638404

THE AMBIENT GROUP LLC

Order : 950949

Camden, NJ. ABC Barrel Project

Tkt. No.

1006027730

P.O. :

Product 114203

Bank Run

S.O. Info: Camden, NJ.

Ship Ref: 327 N. Front St



	Pounds	Kilo
Gross	77,500	35,153
Tare	24,600 *	11,158
Net	52,900	23,995

26.45 Ton 24.00

* Predetermined Tare

Today Tons:	771.12	Loads:
Tons To Date:	8,246.82	30
Today Tonnes	699.55	
Tonnes To Date:	7,481.39	

	UNIT	TOTALS
Material:		
Freight:		
Tax:		
Fee / Fuel:		
Other Chrg: No		

By acceptance of this ticket (with or without signature), driver accepts on behalf of themselves/their employer sole responsibility to ensure that the load received is within the weight limit authorized by law and shall hold seller harmless against any and all claims with respect to same CURB DELIVERY ONLY. NOT RESPONSIBLE FOR ANY DAMAGE BEYOND CURB.

Carrier : 2346970 GEORGE LAZOS TRUCKING

Vehicle: LG004

AP213T

License: LG004

MaxGVW: 80,000

Received: _____ Cust: _____

Weighmaster: Colleen LeSage

P/D Status: Deliver

Customer Copy

Scale: 1



Plant: 32411

Berlin

368 New Brooklyn Road
Berlin, NJ 08009
856-809-0142

3/22/2017 13:58

In :

Customer: 8638404 THE AMBIENT GROUP LLC

Order : 950949 Camden, NJ. ABC Barrel Project

P.O. :

Tkt. No. 1006027732

Product 114203

Bank Run

S.O. Info: Camden, NJ.

Ship Ref: 327 N. Front St



	Pounds	Kilo
Gross	78,540	35,625
Tare	28,120 *	12,755
Net	50,420	22,870

25.21 Ton 22.87

* Predetermined Tare

Today Tons:	796.33	Loads:
Tons To Date:	8,272.03	31
Today Tonnes	722.42	
Tonnes To Date:	7,504.26	

	UNIT	TOTALS
Material:		
Freight:		
Tax:		
Fee / Fuel:		
Other Chrg: No		

By acceptance of this ticket (with or without signature), driver accepts on behalf of themselves/their employer sole responsibility to ensure that the load received is within the weight limit authorized by law and shall hold seller harmless against any and all claims with respect to same CURB DELIVERY ONLY. NOT RESPONSIBLE FOR ANY DAMAGE BEYOND CURB.

Carrier : 8040648 GJ SCOTT LLC

Vehicle: GS16 GS16

License: AT639K

MaxGVW: 80,000

Received: _____

Weighmaster: Colleen LeSage

Cust: _____

P/D Status: Deliver

Customer Copy

Scale: 1



Plant: 32411

Berlin

368 New Brooklyn Road
Berlin, NJ 08009
856-809-0142

3/22/2017 14:01

In :

Customer: 8638404 THE AMBIENT GROUP LLC

Order : 950949 Camden, NJ. ABC Barrel Project

P.O. :

Tkt. No. 1006027733

Product 114203

Bank Run

S.O. Info: Camden, NJ.

Ship Ref: 327 N. Front St



	Pounds	Kilo
Gross	76,980	34,918
Tare	27,040 *	12,265
Net	49,940	22,652

24.97 Ton 22.65

* Predetermined Tare

Today Tons:	821.30	Loads:
Tons To Date:	8,297.00	32
Today Tonnes	745.07	
Tonnes To Date:	7,526.91	

By acceptance of this ticket (with or without signature), driver accepts on behalf of themselves/their employer sole responsibility to ensure that the load received is within the weight limit authorized by law and shall hold seller harmless against any and all claims with respect to same CURB DELIVERY ONLY. NOT RESPONSIBLE FOR ANY DAMAGE BEYOND CURB.

Carrier : 8040648 GJ SCOTT LLC

Vehicle: GS6 GS6

License: AK761C

MaxGVW: 80,000

Received: _____

Weighmaster: Colleen LeSage

Cust: _____

P/D Status: Deliver

Customer Copy

Scale: 1



Plant: 32411

Berlin

368 New Brooklyn Road
Berlin, NJ 08009
856-809-0142

3/23/2017 07:18 In: 6:45:20
Customer: 8638404 THE AMBIENT GROUP LLC
Order: 950949 Camden, NJ. ABC Barrel Project
P.O.:

Tkt. No. 1006027739

Product 114203
Bank Run
S.O. Info: Camden, NJ
Ship Ref: 327 N. Front St



	Pounds	Kilo
Gross	75,980	34,464
Tare	24,580	11,149
Net	51,400	23,315

25.70 Ton 23.31

	UNIT	TOTALS
Material:		
Freight:		
Tax:		
Fee / Fuel:		
Other Chrg: No		

Today Tons:	25.70	Loads:
Tons To Date:	8,322.70	1
Today Tonnes	23.31	
Tonnes To Date:	7,550.23	

Carrier: 2346970 GEORGE LAZOS TRUCKING
Vehicle: LG004 AP213T
License: LG004
MaxGVW: 80,000

By acceptance of this ticket (with or without signature), driver accepts on behalf of themselves/their employer sole responsibility to ensure that the load received is within the weight limit authorized by law and shall holdseller harmless against any and all claims with respect to same CURB DELIVERY ONLY. NOT RESPONSIBLE FOR ANY DAMAGE BEYOND CURB.

Received: _____
Weighmaster: Colleen LeSage

Cust: _____

P/D Status: Deliver

Customer Copy Scale: 1



Plant: 32411

Berlin

368 New Brooklyn Road
Berlin, NJ 08009
856-809-0142

3/23/2017 07:21 In: 6:41:08
Customer: 8638404 THE AMBIENT GROUP LLC
Order: 950949 Camden, NJ. ABC Barrel Project
P.O.:

Tkt. No. 1006027740

Product 114203
Bank Run
S.O. Info: Camden, NJ
Ship Ref: 327 N. Front St



	Pounds	Kilo
Gross	78,320	35,525
Tare	28,620	12,982
Net	49,700	22,544

24.85 Ton 22.54

	UNIT	TOTALS
Material:		
Freight:		
Tax:		
Fee / Fuel:		
Other Chrg: No		

Today Tons:	50.55	Loads:
Tons To Date:	8,347.55	2
Today Tonnes	45.86	
Tonnes To Date:	7,572.77	

Carrier: 8040648 GJ SCOTT LLC
Vehicle: GS15 GS15
License: AS672T
MaxGVW: 80,000

By acceptance of this ticket (with or without signature), driver accepts on behalf of themselves/their employer sole responsibility to ensure that the load received is within the weight limit authorized by law and shall holdseller harmless against any and all claims with respect to same CURB DELIVERY ONLY. NOT RESPONSIBLE FOR ANY DAMAGE BEYOND CURB.

Received: _____
Weighmaster: Colleen LeSage

Cust: _____

P/D Status: Deliver

Customer Copy Scale: 1



Plant: 32411

Berlin

368 New Brooklyn Road
Berlin, NJ 08009
856-809-0142

3/23/2017 07:24 In: 6:44:08
Customer: 8638404 THE AMBIENT GROUP LLC
Order : 950949 Camden, NJ. ABC Barrel Project
P.O. :

Tkt. No. 1006027741

Product 114203
Bank Run
S.O. Info: Camden, NJ.
Ship Ref: 327 N. Front St



	Pounds	Kilo
Gross	76,200	34,564
Tare	28,080	12,737
Net	48,120	21,827
	24.06 Ton	21.83

	UNIT	TOTALS
Material:		
Freight:		
Tax:		
Fee / Fuel:		
Other Chrg: No		

Today Tons:	74.61	Loads:
Tons To Date:	8,371.61	3
Today Tonnes	67.69	
Tonnes To Date:	7,594.60	

By acceptance of this ticket (with or without signature), driver accepts on behalf of themselves/their employer sole responsibility to ensure that the load received is within the weight limit authorized by law and shall hold seller harmless against any and all claims with respect to same CURB DELIVERY ONLY. NOT RESPONSIBLE FOR ANY DAMAGE BEYOND CURB.

Carrier : 8040648 GJ SCOTT LLC
Vehicle: GS16 GS16
License: AT639K
MaxGVW: 80,000

Received: _____
Weighmaster: Colleen LeSage

Cust: _____

P/D Status: Deliver

Customer Copy

Scale: 1



Plant: 32411

Berlin

368 New Brooklyn Road
Berlin, NJ 08009
856-809-0142

3/23/2017 07:26 In: 6:44:32
Customer: 8638404 THE AMBIENT GROUP LLC
Order : 950949 Camden, NJ. ABC Barrel Project
P.O. :

Tkt. No. 1006027742

Product 114203
Bank Run
S.O. Info: Camden, NJ.
Ship Ref: 327 N. Front St



	Pounds	Kilo
Gross	76,600	34,745
Tare	28,400	12,882
Net	48,200	21,863
	24.10 Ton	21.86

	UNIT	TOTALS
Material:		
Freight:		
Tax:		
Fee / Fuel:		
Other Chrg: No		

Today Tons:	98.71	Loads:
Tons To Date:	8,395.71	4
Today Tonnes	89.55	
Tonnes To Date:	7,616.46	

By acceptance of this ticket (with or without signature), driver accepts on behalf of themselves/their employer sole responsibility to ensure that the load received is within the weight limit authorized by law and shall hold seller harmless against any and all claims with respect to same CURB DELIVERY ONLY. NOT RESPONSIBLE FOR ANY DAMAGE BEYOND CURB.

Carrier : 8040648 GJ SCOTT LLC
Vehicle: GS17 GS17
License: AT640K
MaxGVW: 80,000

Received: _____
Weighmaster: Colleen LeSage

Cust: _____

P/D Status: Deliver

Customer Do Not Accept [1]

Scale: 1



Plant: 32411

Berlin

368 New Brooklyn Road
Berlin, NJ 08009
856-809-0142

3/23/2017 07:29

In: 6:45:00

Customer: 8638404

THE AMBIENT GROUP LLC

Order: 950949

Camden, NJ. ABC Barrel Project

Tkt. No. 1006027743

P.O.:

Product 114203

Bank Run

S.O. Info: Camden, NJ.

Ship Ref: 327 N. Front St



	UNIT	TOTALS
Material:		
Freight:		
Tax:		
Fee / Fuel:		
Other Chrg: No		

	Pounds	Kilo
Gross	77,200	35,017
Tare	27,880	12,646
Net	49,320	22,371
	24.66 Ton	22.37

Today Tons:	123.37	Loads:
Tons To Date:	8,420.37	5
Today Tonnes	111.92	
Tonnes To Date:	7,638.83	

By acceptance of this ticket (with or without signature), driver accepts on behalf of themselves/their employer sole responsibility to ensure that the load received is within the weight limit authorized by law and shall hold seller harmless against any and all claims with respect to same
CURB DELIVERY ONLY. NOT RESPONSIBLE FOR ANY DAMAGE BEYOND CURB.

Carrier: 8040648 GJ SCOTT LLC

Vehicle: GS4

GS4

License: AJ118L

MaxGVW: 80,000

Received: _____

Cust: _____

Weighmaster: Colleen LeSage

P/D Status: Deliver

Customer Do Not Accept [1] Scale: 1



Plant: 32411

Berlin

368 New Brooklyn Road
Berlin, NJ 08009
856-809-0142

3/23/2017 07:38

In: 6:50:14

Customer: 8638404

THE AMBIENT GROUP LLC

Order: 950949

Camden, NJ. ABC Barrel Project

Tkt. No. 1006027747

P.O.:

Product 114203

Bank Run

S.O. Info: Camden, NJ.

Ship Ref: 327 N. Front St



	UNIT	TOTALS
Material:		
Freight:		
Tax:		
Fee / Fuel:		
Other Chrg: No		

	Pounds	Kilo
Gross	77,320	35,072
Tare	25,820	11,712
Net	51,500	23,360
	25.75 Ton	23.36

Today Tons:	149.12	Loads:
Tons To Date:	8,446.12	6
Today Tonnes	135.28	
Tonnes To Date:	7,662.19	

By acceptance of this ticket (with or without signature), driver accepts on behalf of themselves/their employer sole responsibility to ensure that the load received is within the weight limit authorized by law and shall hold seller harmless against any and all claims with respect to same
CURB DELIVERY ONLY. NOT RESPONSIBLE FOR ANY DAMAGE BEYOND CURB.

Carrier: 8647386 TURKEYROOST TRANSPORT

Vehicle: TUR001

Turkeyroost

License: AP182A

MaxGVW: 80,000

Received: _____

Cust: _____

Weighmaster: Colleen LeSage

P/D Status: Deliver

Customer Do Not Accept [3] Scale: 1



Plant: 32411

Berlin

368 New Brooklyn Road
Berlin, NJ 08009
856-809-0142

3/23/2017 07:44 In: 7:23:49
Customer: 8638404 THE AMBIENT GROUP LLC
Order : 950949 Camden, NJ. ABC Barrel Project
P.O. :

Tkt. No. 1006027748

Product 114203
Bank Run
S.O. Info: Camden, NJ.
Ship Ref: 327 N. Front St



	Pounds	Kilo
Gross	75,800	34,382
Tare	29,080	13,190
Net	46,720	21,192
	23.36 Ton	21.19

	UNIT	TOTALS
Material:		
Freight:		
Tax:		
Fee / Fuel:		
Other Chrg: No		

Today Tons:	172.48	Loads:
Tons To Date:	8,469.48	7
Today Tonnes	156.47	
Tonnes To Date:	7,683.38	

Carrier : 9109539 VML TRUCKING2 LLC
Vehicle: VML102 XASG14
License: XASG14
MaxGVW: 80,000

By acceptance of this ticket (with or without signature), driver accepts on behalf of themselves/their employer sole responsibility to ensure that the load received is within the weight limit authorized by law and shall hold seller harmless against any and all claims with respect to same CURB DELIVERY ONLY. NOT RESPONSIBLE FOR ANY DAMAGE BEYOND CURB.

Received: _____
Weighmaster: Colleen LeSage

Cust: _____

P/D Status: Deliver

Customer Copy

Scale: 1



Plant: 32411

Berlin

368 New Brooklyn Road
Berlin, NJ 08009
856-809-0142

3/23/2017 08:37 In: 8:17:33
Customer: 8638404 THE AMBIENT GROUP LLC
Order : 950949 Camden, NJ. ABC Barrel Project
P.O. :

Tkt. No. 1006027753

Product 114203
Bank Run
S.O. Info: Camden, NJ.
Ship Ref: 327 N. Front St



	Pounds	Kilo
Gross	76,020	34,482
Tare	23,440	10,632
Net	52,580	23,850
	26.29 Ton	23.85

	UNIT	TOTALS
Material:		
Freight:		
Tax:		
Fee / Fuel:		
Other Chrg: No		

Today Tons:	198.77	Loads:
Tons To Date:	8,495.77	8
Today Tonnes	180.32	
Tonnes To Date:	7,707.23	

Carrier : 8515471 CALLE TRUCKING LLC
Vehicle: CALLE9 Grey truck
License: AG07469
MaxGVW: 80,000

By acceptance of this ticket (with or without signature), driver accepts on behalf of themselves/their employer sole responsibility to ensure that the load received is within the weight limit authorized by law and shall hold seller harmless against any and all claims with respect to same CURB DELIVERY ONLY. NOT RESPONSIBLE FOR ANY DAMAGE BEYOND CURB.

Received: _____
Weighmaster: Colleen LeSage

Cust: _____

P/D Status: Deliver

Customer Copy

Scale: 1



Plant: 32411

Berlin
368 New Brooklyn Road
Berlin, NJ 08009
856-809-0142

3/23/2017 09:02 In:
Customer: 8638404 THE AMBIENT GROUP LLC
Order: 950949 Camden, NJ. ABC Barrel Project
P.O.:

Tkt. No. 1006027755



Product 114203
Bank Run
S.O. Info: Camden, NJ.
Ship Ref: 327 N. Front St

	Pounds	Kilo
Gross	78,000	35,380
Tare	28,620 *	12,982
Net	49,380	22,398
24.69 Ton		22.40

* Predetermined Tare

	UNIT	TOTALS
Material:		
Freight:		
Tax:		
Fee / Fuel:		
Other Chrg: <u>No</u>		

Today Tons:	223.46	Loads:	
Tons To Date:	8,520.46		9
Today Tonnes	202.72		
Tonnes To Date:	7,729.63		

Carrier: 8040648 GJ SCOTT LLC
Vehicle: GS15 GS15
License: AS672T
MaxGVW: 80,000

By acceptance of this ticket (with or without signature), driver accepts on behalf of themselves/their employer sole responsibility to ensure that the load received is within the weight limit authorized by law and shall hold seller harmless against any and all claims with respect to same CURB DELIVERY ONLY. NOT RESPONSIBLE FOR ANY DAMAGE BEYOND CURB.

Received: [Signature]
Weighmaster: Colleen LeSage

Cust: _____

P/D Status: Deliver

Customer Do Not Accept [2] Scale: 1



Plant: 32411

Berlin
368 New Brooklyn Road
Berlin, NJ 08009
856-809-0142

3/23/2017 09:05 In:
Customer: 8638404 THE AMBIENT GROUP LLC
Order: 950949 Camden, NJ. ABC Barrel Project
P.O.:

Tkt. No. 1006027756



Product 114203
Bank Run
S.O. Info: Camden, NJ.
Ship Ref: 327 N. Front St

	Pounds	Kilo
Gross	77,960	35,362
Tare	24,580 *	11,149
Net	53,380	24,213
26.69 Ton		24.21

* Predetermined Tare

	UNIT	TOTALS
Material:		
Freight:		
Tax:		
Fee / Fuel:		
Other Chrg: <u>No</u>		

Today Tons:	250.15	Loads:	
Tons To Date:	8,547.15		10
Today Tonnes	226.93		
Tonnes To Date:	7,753.84		

Carrier: 2346970 GEORGE LAZOS TRUCKING
Vehicle: LG004 AP213T
License: LG004
MaxGVW: 80,000

By acceptance of this ticket (with or without signature), driver accepts on behalf of themselves/their employer sole responsibility to ensure that the load received is within the weight limit authorized by law and shall hold seller harmless against any and all claims with respect to same CURB DELIVERY ONLY. NOT RESPONSIBLE FOR ANY DAMAGE BEYOND CURB.

Received: _____
Weighmaster: Colleen LeSage

Cust: _____

P/D Status: Deliver

Customer Copy Scale: 1



Plant: 32411

Berlin

368 New Brooklyn Road
Berlin, NJ 08009
856-809-0142

3/23/2017 09:08

In :

Customer: 8638404 THE AMBIENT GROUP LLC

Order : 950949 Camden, NJ. ABC Barrel Project

P.O. :

Tkt. No. 1006027757

Product 114203

Bank Run

S.O. Info: Camden, NJ.

Ship Ref: 327 N. Front St



	Pounds	Kilo
Gross	79,000	35,834
Tare	28,080 *	12,737
Net	50,920	23,097

25.46 Ton 23.10

* Predetermined Tare

	UNIT	TOTALS
Material:		
Freight:		
Tax:		
Fee / Fuel:		
Other Chrg: No		

Today Tons:	275.61	Loads:
Tons To Date:	8,572.61	11
Today Tonnes	250.03	
Tonnes To Date:	7,776.94	

Carrier : 8040648 GJ SCOTT LLC

Vehicle: GS16 GS16

License: AT639K

MaxGVW: 80,000

Received:

Weighmaster: Colleen LeSage

Cust: _____

P/D Status: Deliver

Customer Copy

Scale: 1

By acceptance of this ticket (with or without signature), driver accepts on behalf of themselves/their employer sole responsibility to ensure that the load received is within the weight limit authorized by law and shall hold seller harmless against any and all claims with respect to same CURB DELIVERY ONLY. NOT RESPONSIBLE FOR ANY DAMAGE BEYOND CURB.



Plant: 32411

Berlin

368 New Brooklyn Road
Berlin, NJ 08009
856-809-0142

3/23/2017 09:11

In :

Customer: 8638404 THE AMBIENT GROUP LLC

Order : 950949 Camden, NJ. ABC Barrel Project

P.O. :

Tkt. No. 1006027758

Product 114203

Bank Run

S.O. Info: Camden, NJ.

Ship Ref: 327 N. Front St



	Pounds	Kilo
Gross	79,020	35,843
Tare	28,400 *	12,882
Net	50,620	22,961

25.31 Ton 22.96

* Predetermined Tare

	UNIT	TOTALS
Material:		
Freight:		
Tax:		
Fee / Fuel:		
Other Chrg: No		

Today Tons:	300.92	Loads:
Tons To Date:	8,597.92	12
Today Tonnes	272.99	
Tonnes To Date:	7,799.90	

Carrier : 8040648 GJ SCOTT LLC

Vehicle: GS17 GS17

License: AT640K

MaxGVW: 80,000

Received: _____

Weighmaster: Colleen LeSage

Cust: _____

P/D Status: Deliver

Customer Do Not Accept [3]

Scale: 1

By acceptance of this ticket (with or without signature), driver accepts on behalf of themselves/their employer sole responsibility to ensure that the load received is within the weight limit authorized by law and shall hold seller harmless against any and all claims with respect to same CURB DELIVERY ONLY. NOT RESPONSIBLE FOR ANY DAMAGE BEYOND CURB.



Plant: 32411

Berlin
368 New Brooklyn Road
Berlin, NJ 08009
856-809-0142

3/23/2017 09:12 In :
Customer: 8638404 THE AMBIENT GROUP LLC
Order : 950949 Camden, NJ. ABC Barrel Project
P.O. :

Tkt. No. 1006027759



Product 114203
Bank Run
S.O. Info: Camden, NJ.
Ship Ref: 327 N. Front St

	Pounds	Kilo
Gross	78,240	35,489
Tare	27,880 *	12,646
Net	50,360	22,843

25.18 Ton 22.84
* Predetermined Tare

Today Tons:	326.10	Loads:
Tons To Date:	8,623.10	13
Today Tonnes	295.83	
Tonnes To Date:	7,822.74	

	UNIT	TOTALS
Material:		
Freight:		
Tax:		
Fee / Fuel:		
Other Chrg: No		

Carrier : 8040648 GJ SCOTT LLC
Vehicle: GS4 GS4
License: AJ118L
MaxGVW: 80,000

By acceptance of this ticket (with or without signature), driver accepts on behalf of themselves/their employer sole responsibility to ensure that the load received is within the weight limit authorized by law and shall hold seller harmless against any and all claims with respect to same CURB DELIVERY ONLY. NOT RESPONSIBLE FOR ANY DAMAGE BEYOND CURB.

Received: _____ Cust: _____
Weighmaster: Colleen LeSage

P/D Status: Deliver

Customer Do Not Accept [3] Scale: 1



Plant: 32411

Berlin
368 New Brooklyn Road
Berlin, NJ 08009
856-809-0142

3/23/2017 09:14 In :
Customer: 8638404 THE AMBIENT GROUP LLC
Order : 950949 Camden, NJ. ABC Barrel Project
P.O. :

Tkt. No. 1006027760



Product 114203
Bank Run
S.O. Info: Camden, NJ.
Ship Ref: 327 N. Front St

	Pounds	Kilo
Gross	78,800	35,743
Tare	25,820 *	11,712
Net	52,980	24,031

26.49 Ton 24.03
* Predetermined Tare

Today Tons:	352.59	Loads:
Tons To Date:	8,649.59	14
Today Tonnes	319.86	
Tonnes To Date:	7,846.78	

	UNIT	TOTALS
Material:		
Freight:		
Tax:		
Fee / Fuel:		
Other Chrg: No		

Carrier : 8647386 TURKEYROOST TRANSPORT
Vehicle: TUR001 Turkeyroost
License: AP182A
MaxGVW: 80,000

By acceptance of this ticket (with or without signature), driver accepts on behalf of themselves/their employer sole responsibility to ensure that the load received is within the weight limit authorized by law and shall hold seller harmless against any and all claims with respect to same CURB DELIVERY ONLY. NOT RESPONSIBLE FOR ANY DAMAGE BEYOND CURB.

Received: _____ Cust: _____
Weighmaster: Colleen LeSage

P/D Status: Deliver

Customer Copy Scale: 1



Plant: 32411

Berlin
368 New Brooklyn Road
Berlin, NJ 08009
856-809-0142

3/23/2017 09:29 In: 9:11:08
Customer: 8638404 THE AMBIENT GROUP LLC
Order : 950949 Camden, NJ. ABC Barrel Project
P.O. :

Tkt. No. 1006027765



Product 114203
Bank Run
S.O. Info: Camden, NJ.
Ship Ref: 327 N. Front St

	Pounds	Kilo
Gross	78,860	35,770
Tare	26,260	11,911
Net	52,600	23,859
26.30 Ton		23.86

	UNIT	TOTALS
Material:		
Freight:		
Tax:		
Fee / Fuel:		
Other Chrg: No		

Today Tons:	378.89	Loads:
Tons To Date:	8,675.89	15
Today Tonnes	343.72	
Tonnes To Date:	7,870.64	

By acceptance of this ticket (with or without signature), driver accepts on behalf of themselves/their employer sole responsibility to ensure that the load received is within the weight limit authorized by law and shall hold seller harmless against any and all claims with respect to same CURB DELIVERY ONLY. NOT RESPONSIBLE FOR ANY DAMAGE BEYOND CURB.

Carrier : 2347032 ROCKY LOGIOVINO TRUCKIN
Vehicle: LR060 Rocky
License: AM637B
MaxGVW: 80,000
Received: _____
Weighmaster: Colleen LeSage

Cust: _____

P/D Status: Deliver

Customer Do Not Accept [2] Scale: 1



Plant: 32411

Berlin
368 New Brooklyn Road
Berlin, NJ 08009
856-809-0142

3/23/2017 09:31 In :
Customer: 8638404 THE AMBIENT GROUP LLC
Order : 950949 Camden, NJ. ABC Barrel Project
P.O. :

Tkt. No. 1006027766



Product 114203
Bank Run
S.O. Info: Camden, NJ.
Ship Ref: 327 N. Front St

	Pounds	Kilo
Gross	76,920	34,890
Tare	29,080 *	13,190
Net	47,840	21,700
23.92 Ton		21.70

	UNIT	TOTALS
Material:		
Freight:		
Tax:		
Fee / Fuel:		
Other Chrg: No		

* Predetermined Tare

Today Tons:	402.81	Loads:
Tons To Date:	8,699.81	16
Today Tonnes	365.42	
Tonnes To Date:	7,892.33	

By acceptance of this ticket (with or without signature), driver accepts on behalf of themselves/their employer sole responsibility to ensure that the load received is within the weight limit authorized by law and shall hold seller harmless against any and all claims with respect to same CURB DELIVERY ONLY. NOT RESPONSIBLE FOR ANY DAMAGE BEYOND CURB.

Carrier : 9109539 VML TRUCKING2 LLC
Vehicle: VML102 XASG14
License: XASG14
MaxGVW: 80,000
Received: _____
Weighmaster: Colleen LeSage

Cust: _____

P/D Status: Deliver

Customer Do Not Accept [2] Scale: 1



Plant: 32411

Berlin

368 New Brooklyn Road
Berlin, NJ 08009
856-809-0142

3/23/2017 09:41 In :
Customer: 8638404 THE AMBIENT GROUP LLC
Order : 950949 Camden, NJ. ABC Barrel Project
P.O. :

Tkt. No. 1006027767



Product 114203
Bank Run
S.O. Info: Camden, NJ.
Ship Ref: 327 N. Front St

	Pounds	Kilo
Gross	77,680	35,235
Tare	24,440 *	11,086
Net	53,240	24,149

26.62 Ton 24.15

* Predetermined Tare

UNIT	TOTALS
Material:	
Freight:	
Tax:	
Fee / Fuel:	
Other Chrg: <u>No</u>	

Today Tons:	429.43	Loads:
Tons To Date:	8,726.43	17
Today Tonnes	389.57	
Tonnes To Date:	7,916.48	

By acceptance of this ticket (with or without signature), driver accepts on behalf of themselves/their employer sole responsibility to ensure that the load received is within the weight limit authorized by law and shall hold seller harmless against any and all claims with respect to same CURB DELIVERY ONLY. NOT RESPONSIBLE FOR ANY DAMAGE BEYOND CURB.

Carrier : 8540415 S CUMMINS LLC
Vehicle: CUM17 Steve
License: AT979F
MaxGVW: 80,000

Received: _____
Weighmaster: Colleen LeSage

Cust: _____

P/D Status: Deliver

Customer Do Not Accept [2] Scale: 1



Plant: 32411

Berlin

368 New Brooklyn Road
Berlin, NJ 08009
856-809-0142

3/23/2017 10:13 In :
Customer: 8638404 THE AMBIENT GROUP LLC
Order : 950949 Camden, NJ. ABC Barrel Project
P.O. :

Tkt. No. 1006027769



Product 114203
Bank Run
S.O. Info: Camden, NJ.
Ship Ref: 327 N. Front St

	Pounds	Kilo
Gross	74,980	34,010
Tare	23,440 *	10,632
Net	51,540	23,378

25.77 Ton 23.38

* Predetermined Tare

UNIT	TOTALS
Material:	
Freight:	
Tax:	
Fee / Fuel:	
Other Chrg: <u>No</u>	

Today Tons:	455.20	Loads:
Tons To Date:	8,752.20	18
Today Tonnes	412.95	
Tonnes To Date:	7,939.86	

By acceptance of this ticket (with or without signature), driver accepts on behalf of themselves/their employer sole responsibility to ensure that the load received is within the weight limit authorized by law and shall hold seller harmless against any and all claims with respect to same CURB DELIVERY ONLY. NOT RESPONSIBLE FOR ANY DAMAGE BEYOND CURB.

Carrier : 8515471 CALLE TRUCKING LLC
Vehicle: CALLE9 Grey truck
License: AG07469
MaxGVW: 80,000

Received: Colleen LeSage
Weighmaster: Colleen LeSage

Cust: _____

P/D Status: Deliver

Customer Do Not Accept [2] Scale: 1



Plant: 32411

Berlin

368 New Brooklyn Road
Berlin, NJ 08009
856-809-0142.

3/23/2017 10:31 In:
Customer: 8638404 THE AMBIENT GROUP LLC
Order : 950949 Camden, NJ. ABC Barrel Project
P.O. :

Tkt. No. 1006027770

Product 114203
Bank Run
S.O. Info: Camden, NJ.
Ship Ref: 327 N. Front St



	Pounds	Kilo
Gross	78,880	35,779
Tare	28,620 *	12,982
Net	50,260	22,798

25.13 Ton 22.80

* Predetermined Tare

	UNIT	TOTALS
Material:		
Freight:		
Tax:		
Fee / Fuel:		
Other Chrg:	No	

Today Tons:	480.33	Loads:
Tons To Date:	8,777.33	19
Today Tonnes	435.75	
Tonnes To Date:	7,962.66	

Carrier : 8040648 GJ SCOTT LLC
Vehicle: GS15 GS15
License: AS672T
MaxGVW: 80,000

By acceptance of this ticket (with or without signature), driver accepts on behalf of themselves/their employer sole responsibility to ensure that the load received is within the weight limit authorized by law and shall holdseller harmless against any and all claims with respect to same
CURB DELIVERY ONLY. NOT RESPONSIBLE FOR ANY DAMAGE BEYOND CURB.

Received:
Weighmaster: Colleen LeSage

Cust: _____

P/D Status: Deliver

Customer Copy Scale: 1



Plant: 32411

Berlin

368 New Brooklyn Road
Berlin, NJ 08009
856-809-0142.

3/23/2017 10:34 In:
Customer: 8638404 THE AMBIENT GROUP LLC
Order : 950949 Camden, NJ. ABC Barrel Project
P.O. :

Tkt. No. 1006027771

Product 114203
Bank Run
S.O. Info: Camden, NJ.
Ship Ref: 327 N. Front St



	Pounds	Kilo
Gross	77,900	35,335
Tare	28,080 *	12,737
Net	49,820	22,598

24.91 Ton 22.60

* Predetermined Tare

	UNIT	TOTALS
Material:		
Freight:		
Tax:		
Fee / Fuel:		
Other Chrg:	No	

Today Tons:	505.24	Loads:
Tons To Date:	8,802.24	20
Today Tonnes	458.35	
Tonnes To Date:	7,985.26	

Carrier : 8040648 GJ SCOTT LLC
Vehicle: GS16 GS16
License: AT639K
MaxGVW: 80,000

By acceptance of this ticket (with or without signature), driver accepts on behalf of themselves/their employer sole responsibility to ensure that the load received is within the weight limit authorized by law and shall holdseller harmless against any and all claims with respect to same
CURB DELIVERY ONLY. NOT RESPONSIBLE FOR ANY DAMAGE BEYOND CURB.

Received:
Weighmaster: Colleen LeSage

Cust: _____

P/D Status: Deliver

Customer Copy Scale: 1



Plant: 32411

Berlin

368 New Brooklyn Road
Berlin, NJ 08009
856-809-0142

3/23/2017 10:36

In :

Customer: 8638404 THE AMBIENT GROUP LLC

Order : 950949 Camden, NJ. ABC Barrel Project

P.O. :

Tkt. No. 1006027772

Product 114203



Bank Run

S.O. Info: Camden, NJ.

Ship Ref: 327 N. Front St

	Pounds	Kilo
Gross	79,000	35,834
Tare	28,400 *	12,882
Net	50,600	22,952

25.30 Ton 22.95

* Predetermined Tare

Today Tons:	530.54	Loads:
Tons To Date:	8,827.54	21
Today Tonnes	481.30	
Tonnes To Date:	8,008.21	

	UNIT	TOTALS
Material:		
Freight:		
Tax:		
Fee / Fuel:		
Other Chrg: No		

By acceptance of this ticket (with or without signature), driver accepts on behalf of themselves/their employer sole responsibility to ensure that the load received is within the weight limit authorized by law and shall hold seller harmless against any and all claims with respect to same
CURB DELIVERY ONLY. NOT RESPONSIBLE FOR ANY DAMAGE BEYOND CURB.

Carrier : 8040648 GJ SCOTT LLC

Vehicle: GS17 GS17

License: AT640K

MaxGVW: 80,000

Received: _____

Cust: _____

Weighmaster: Colleen LeSage

P/D Status: Deliver

Customer Do Not Accept [1] Scale: 1



Plant: 32411

Berlin

368 New Brooklyn Road
Berlin, NJ 08009
856-809-0142

3/23/2017 10:39

In :

Customer: 8638404 THE AMBIENT GROUP LLC

Order : 950949 Camden, NJ. ABC Barrel Project

P.O. :

Tkt. No. 1006027773

Product 114203

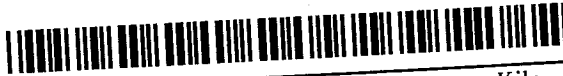

Bank Run

S.O. Info: Camden, NJ.

Ship Ref: 327 N. Front St

	Pounds	Kilo
Gross	78,440	35,580
Tare	27,880 *	12,646
Net	50,560	22,934

25.28 Ton 22.93

* Predetermined Tare

Today Tons:	555.82	Loads:
Tons To Date:	8,852.82	22
Today Tonnes	504.23	
Tonnes To Date:	8,031.14	

By acceptance of this ticket (with or without signature), driver accepts on behalf of themselves/their employer sole responsibility to ensure that the load received is within the weight limit authorized by law and shall hold seller harmless against any and all claims with respect to same
CURB DELIVERY ONLY. NOT RESPONSIBLE FOR ANY DAMAGE BEYOND CURB.

	UNIT	TOTALS
Material:		
Freight:		
Tax:		
Fee / Fuel:		
Other Chrg: No		

Carrier : 8040648 GJ SCOTT LLC

Vehicle: GS4 GS4

License: AJ118L

MaxGVW: 80,000

Received: _____

Cust: _____

Weighmaster: Colleen LeSage

P/D Status: Deliver

Customer Copy Scale: 1



Plant: 32411

Berlin

368 New Brooklyn Road
Berlin, NJ 08009
856-809-0142

3/23/2017 10:43

In:

Customer: 8638404 THE AMBIENT GROUP LLC

Order: 950949 Camden, NJ. ABC Barrel Project

P.O.:

Tkt. No. 1006027774

Product 114203

Bank Run

S.O. Info: Camden, NJ.

Ship Ref: 327 N. Front St



	Pounds	Kilo
Gross	77,020	34,936
Tare	24,580 *	11,149
Net	52,440	23,786

26.22 Ton 23.79

* Predetermined Tare

Today Tons:	582.04	Loads:
Tons To Date:	8,879.04	23
Today Tonnes	528.02	
Tonnes To Date:	8,054.93	

	UNIT	TOTALS
Material:		
Freight:		
Tax:		
Fee / Fuel:		
Other Chrg: No		

Carrier: 2346970 GEORGE LAZOS TRUCKING

Vehicle: LG004 AP213T

License: LG004

MaxGVW: 80,000

Received:

Weighmaster: Colleen LeSage

Cust:

P/D Status: Deliver

Customer Copy

Scale: 1

By acceptance of this ticket (with or without signature), driver accepts on behalf of themselves/their employer sole responsibility to ensure that the load received is within the weight limit authorized by law and shall hold seller harmless against any and all claims with respect to same CURB DELIVERY ONLY. NOT RESPONSIBLE FOR ANY DAMAGE BEYOND CURB.



Plant: 32411

Berlin

368 New Brooklyn Road
Berlin, NJ 08009
856-809-0142

3/23/2017 10:45

In:

Customer: 8638404 THE AMBIENT GROUP LLC

Order: 950949 Camden, NJ. ABC Barrel Project

P.O.:

Tkt. No. 1006027775

Product 114203

Bank Run

S.O. Info: Camden, NJ.

Ship Ref: 327 N. Front St

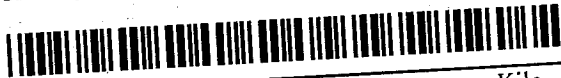

	Pounds	Kilo
Gross	78,740	35,716
Tare	25,820 *	11,712
Net	52,920	24,004

26.46 Ton 24.00

* Predetermined Tare

Today Tons:	608.50	Loads:
Tons To Date:	8,905.50	24
Today Tonnes	552.02	
Tonnes To Date:	8,078.93	

	UNIT	TOTALS
Material:		
Freight:		
Tax:		
Fee / Fuel:		
Other Chrg: No		

Carrier: 8647386 TURKEYROOST TRANSPORT

Vehicle: TUR001 Turkeyroost

License: AP182A

MaxGVW: 80,000

Received:

Weighmaster: Colleen LeSage

Cust:

P/D Status: Deliver

Customer Copy

Scale: 1

By acceptance of this ticket (with or without signature), driver accepts on behalf of themselves/their employer sole responsibility to ensure that the load received is within the weight limit authorized by law and shall hold seller harmless against any and all claims with respect to same CURB DELIVERY ONLY. NOT RESPONSIBLE FOR ANY DAMAGE BEYOND CURB.



Plant: 32411

Berlin

368 New Brooklyn Road
Berlin, NJ 08009
856-809-0142

3/23/2017 11:04 In :
Customer: 8638404 THE AMBIENT GROUP LLC
Order : 950949 Camden, NJ. ABC Barrel Project
P.O. :

Tkt. No. 1006027780

Product 114203
Bank Run
S.O. Info: Camden, NJ.
Ship Ref: 327 N. Front St



	Pounds	Kilo
Gross	78,020	35,389
Tare	29,080 *	13,190
Net	48,940	22,199

24.47 Ton 22.20
* Predetermined Tare

	UNIT	TOTALS
Material:		
Freight:		
Tax:		
Fee / Fuel:		
Other Chrg: No		

Today Tons:	632.97	Loads:
Tons To Date:	8,929.97	25
Today Tonnes	574.22	
Tonnes To Date:	8,101.13	

Carrier : 9109539 VML TRUCKING2 LLC
Vehicle: VML102 XASG14
License: XASG14
MaxGVW: 80,000

By acceptance of this ticket (with or without signature), driver accepts on behalf of themselves/their employer sole responsibility to ensure that the load received is within the weight limit authorized by law and shall holdseller harmless against any and all claims with respect to same CURB DELIVERY ONLY .NOT RESPONSIBLE FOR ANY DAMAGE BEYOND CURB.

Received: _____
Weighmaster: Colleen LeSage

Cust: _____

P/D Status: Deliver

Customer Copy

Scale: 1



Plant: 32411

Berlin

368 New Brooklyn Road
Berlin, NJ 08009
856-809-0142

3/23/2017 11:11 In :
Customer: 8638404 THE AMBIENT GROUP LLC
Order : 950949 Camden, NJ. ABC Barrel Project
P.O. :

Tkt. No. 1006027781

Product 114203
Bank Run
S.O. Info: Camden, NJ.
Ship Ref: 327 N. Front St



	Pounds	Kilo
Gross	79,000	35,834
Tare	26,260 *	11,911
Net	52,740	23,922

26.37 Ton 23.92
* Predetermined Tare

	UNIT	TOTALS
Material:		
Freight:		
Tax:		
Fee / Fuel:		
Other Chrg: No		

Today Tons:	659.34	Loads:
Tons To Date:	8,956.34	26
Today Tonnes	598.14	
Tonnes To Date:	8,125.05	

Carrier : 2347032 ROCKY LOGIOVINO TRUCKIN
Vehicle: LR060 Rocky
License: AM637B
MaxGVW: 80,000

By acceptance of this ticket (with or without signature), driver accepts on behalf of themselves/their employer sole responsibility to ensure that the load received is within the weight limit authorized by law and shall holdseller harmless against any and all claims with respect to same CURB DELIVERY ONLY .NOT RESPONSIBLE FOR ANY DAMAGE BEYOND CURB.

Received: _____
Weighmaster: Colleen LeSage

Cust: _____

P/D Status: Deliver

Customer Copy

Scale: 1



Plant: 32411

Berlin

368 New Brooklyn Road
Berlin, NJ 08009
856-809-0142

3/23/2017 11:13 In :
Customer: 8638404 THE AMBIENT GROUP LLC
Order : 950949 Camden, NJ. ABC Barrel Project
P.O. :

Tkt. No. 1006027782

Product 114203
Bank Run
S.O. Info: Camden, NJ.
Ship Ref: 327 N. Front St



	Pounds	Kilo
Gross	78,420	35,571
Tare	24,440 *	11,086
Net	53,980	24,485

26.99 Ton 24.48
* Predetermined Tare

	UNIT	TOTALS
Material:		
Freight:		
Tax:		
Fee / Fuel:		
Other Chrg: No		

Today Tons:	686.33	Loads:
Tons To Date:	8,983.33	27
Today Tonnes	622.63	
Tonnes To Date:	8,149.54	

Carrier : 8540415 S CUMMINS LLC
Vehicle: CUM17 Steve
License: AT979F
MaxGVW: 80,000

By acceptance of this ticket (with or without signature), driver accepts on behalf of themselves/their employer sole responsibility to ensure that the load received is within the weight limit authorized by law and shall hold seller harmless against any and all claims with respect to same CURB DELIVERY ONLY. NOT RESPONSIBLE FOR ANY DAMAGE BEYOND CURB.

Received: [Signature]
Weighmaster: Colleen LeSage

P/D Status: Deliver

Customer Copy

Scale: 1



Plant: 32411

Berlin

368 New Brooklyn Road
Berlin, NJ 08009
856-809-0142

3/23/2017 11:45 In :
Customer: 8638404 THE AMBIENT GROUP LLC
Order : 950949 Camden, NJ. ABC Barrel Project
P.O. :

Tkt. No. 1006027785

Product 114203
Bank Run
S.O. Info: Camden, NJ.
Ship Ref: 327 N. Front St



	Pounds	Kilo
Gross	76,000	34,473
Tare	24,520 *	11,122
Net	51,480 *	23,351

25.74 Ton 23.35
* Manual Weight

	UNIT	TOTALS
Material:		
Freight:		
Tax:		
Fee / Fuel:		
Other Chrg: No		

Today Tons:	712.07	Loads:
Tons To Date:	9,009.07	28
Today Tonnes	645.98	
Tonnes To Date:	8,172.89	

Carrier : 2347198 RAIO CONTRACTING & MATE
Vehicle: RO214 AH505N
License: AH505N
MaxGVW: 80,000

By acceptance of this ticket (with or without signature), driver accepts on behalf of themselves/their employer sole responsibility to ensure that the load received is within the weight limit authorized by law and shall hold seller harmless against any and all claims with respect to same CURB DELIVERY ONLY. NOT RESPONSIBLE FOR ANY DAMAGE BEYOND CURB.

Received: _____
Weighmaster: Colleen LeSage

Cust: _____

P/D Status: Deliver

Customer Do Not Accept [1]

Scale: 1



Plant: 32411

Berlin
368 New Brooklyn Road
Berlin, NJ 08009
856-809-0142, -

3/23/2017 11:48 In :
Customer: 8638404 THE AMBIENT GROUP LLC
Order : 950949 Camden, NJ. ABC Barrel Project
P.O. :

Tkt. No. 1006027786

Product 114203
Bank Run
S.O. Info: Camden, NJ.
Ship Ref: 327 N. Front St



	Pounds	Kilo
Gross	75,780	34,373
Tare	23,440 *	10,632
Net	52,340	23,741

26.17 Ton 23.74
* Predetermined Tare

	UNIT	TOTALS
Material:		
Freight:		
Tax:		
Fee / Fuel:		
Other Chrg: No		

Today Tons:	738.24	Loads:
Tons To Date:	9,035.24	29
Today Tonnes	669.72	
Tonnes To Date:	8,196.63	

Carrier : 8515471 CALLE TRUCKING LLC
Vehicle: CALLE9 Grey truck
License: AG07469
MaxGVW: 80,000

By acceptance of this ticket (with or without signature), driver accepts on behalf of themselves/their employer sole responsibility to ensure that the load received is within the weight limit authorized by law and shall hold seller harmless against any and all claims with respect to same CURB DELIVERY ONLY. NOT RESPONSIBLE FOR ANY DAMAGE BEYOND CURB.

Received: Colleen LeSage
Weighmaster: Colleen LeSage

Cust: _____

P/D Status: Deliver

Customer Do Not Accept [2] Scale: 1



Plant: 32411

Berlin
368 New Brooklyn Road
Berlin, NJ 08009
856-809-0142, -

3/23/2017 11:54 In : 11:37:29
Customer: 8638404 THE AMBIENT GROUP LLC
Order : 950949 Camden, NJ. ABC Barrel Project
P.O. :

Tkt. No. 1006027787

Product 114203
Bank Run
S.O. Info: Camden, NJ.
Ship Ref: 327 N. Front St



	Pounds	Kilo
Gross	75,440	34,219
Tare	24,660	11,186
Net	50,780	23,033

25.39 Ton 23.03

	UNIT	TOTALS
Material:		
Freight:		
Tax:		
Fee / Fuel:		
Other Chrg: No		

Today Tons:	763.63	Loads:
Tons To Date:	9,060.63	30
Today Tonnes	692.75	
Tonnes To Date:	8,219.67	

Carrier : 2347198 RAO CONTRACTING & MATE
Vehicle: RO219 AJ734F
License: RO219
MaxGVW: 80,000

By acceptance of this ticket (with or without signature), driver accepts on behalf of themselves/their employer sole responsibility to ensure that the load received is within the weight limit authorized by law and shall hold seller harmless against any and all claims with respect to same CURB DELIVERY ONLY. NOT RESPONSIBLE FOR ANY DAMAGE BEYOND CURB.

Received: _____
Weighmaster: Colleen LeSage

Cust: _____

P/D Status: Deliver

Customer Do Not Accept [3] Scale: 1



Plant: 32411

Berlin

368 New Brooklyn Road
Berlin, NJ 08009
856-809-0142

3/23/2017 12:00 In :
Customer: 8638404 THE AMBIENT GROUP LLC
Order : 950949 Camden, NJ. ABC Barrel Project
P.O. :

Tkt. No. 1006027788

Product 114203
Bank Run
S.O. Info: Camden, NJ.
Ship Ref: 327 N. Front St



	Pounds	Kilo
Gross	78,580	35,643
Tare	28,620 *	12,982
Net	49,960	22,661

24.98 Ton 22.66
* Predetermined Tare

	UNIT	TOTALS
Material:		
Freight:		
Tax:		
Fee / Fuel:		
Other Chrg: No		

Today Tons:	788.61	Loads:
Tons To Date:	9,085.61	31
Today Tonnes	715.41	
Tonnes To Date:	8,242.33	

Carrier : 8040648 GJ SCOTT LLC
Vehicle: GS15 GS15
License: AS672T
MaxGVW: 80,000

By acceptance of this ticket (with or without signature), driver accepts on behalf of themselves/their employer sole responsibility to ensure that the load received is within the weight limit authorized by law and shall hold seller harmless against any and all claims with respect to same CURB DELIVERY ONLY. NOT RESPONSIBLE FOR ANY DAMAGE BEYOND CURB.

Received:
Weighmaster: Colleen LeSage

Cust: _____

P/D Status: Deliver

Customer Copy

Scale: 1



Plant: 32411

Berlin

368 New Brooklyn Road
Berlin, NJ 08009
856-809-0142

3/23/2017 12:02 In :
Customer: 8638404 THE AMBIENT GROUP LLC
Order : 950949 Camden, NJ. ABC Barrel Project
P.O. :

Tkt. No. 1006027789

Product 114203
Bank Run
S.O. Info: Camden, NJ.
Ship Ref: 327 N. Front St



	Pounds	Kilo
Gross	77,780	35,280
Tare	28,080 *	12,737
Net	49,700	22,544

24.85 Ton 22.54
* Predetermined Tare

	UNIT	TOTALS
Material:		
Freight:		
Tax:		
Fee / Fuel:		
Other Chrg: No		

Today Tons:	813.46	Loads:
Tons To Date:	9,110.46	32
Today Tonnes	737.96	
Tonnes To Date:	8,264.87	

Carrier : 8040648 GJ SCOTT LLC
Vehicle: GS16 GS16
License: AT639K
MaxGVW: 80,000

By acceptance of this ticket (with or without signature), driver accepts on behalf of themselves/their employer sole responsibility to ensure that the load received is within the weight limit authorized by law and shall hold seller harmless against any and all claims with respect to same CURB DELIVERY ONLY. NOT RESPONSIBLE FOR ANY DAMAGE BEYOND CURB.

Received:
Weighmaster: Colleen LeSage

Cust: _____

P/D Status: Deliver

Customer Copy

Scale: 1



Plant: 32411

Berlin
368 New Brooklyn Road
Berlin, NJ 08009
856-809-0142,-

3/23/2017 12:05 In: 11:47:46
Customer: 8638404 THE AMBIENT GROUP LLC
Order: 950949 Camden, NJ. ABC Barrel Project
P.O.:

Tkt. No. 1006027790

Product 114203
Bank Run
S.O. Info: Camden, NJ.
Ship Ref: 327 N. Front St



	Pounds	Kilo
Gross	74,800	33,929
Tare	24,260	11,004
Net	50,540	22,925
	25.27 Ton	22.92

UNIT	TOTALS
Material:	
Freight:	
Tax:	
Fee / Fuel:	
Other Chrg: No	

Today Tons:	838.73	Loads:
Tons To Date:	9,135.73	33
Today Tonnes	760.88	
Tonnes To Date:	8,287.79	

Carrier : 2347198 RAIO CONTRACTING & MATE
Vehicle: RO217 AH178X
License:
MaxGVW: 80,000
Received: _____
Weighmaster: Colleen LeSage

By acceptance of this ticket (with or without signature), driver accepts on behalf of themselves/their employer sole responsibility to ensure that the load received is within the weight limit authorized by law and shall hold seller harmless against any and all claims with respect to same CURB DELIVERY ONLY. NOT RESPONSIBLE FOR ANY DAMAGE BEYOND CURB.

Cust: _____

P/D Status: Deliver

Customer Do Not Accept [2] Scale: 1



Plant: 32411

Berlin
368 New Brooklyn Road
Berlin, NJ 08009
856-809-0142,-

3/23/2017 12:07 In: _____
Customer: 8638404 THE AMBIENT GROUP LLC
Order: 950949 Camden, NJ. ABC Barrel Project
P.O.:

Tkt. No. 1006027791

Product 114203
Bank Run
S.O. Info: Camden, NJ.
Ship Ref: 327 N. Front St



	Pounds	Kilo
Gross	77,800	35,289
Tare	27,880 *	12,646
Net	49,920	22,643
	24.96 Ton	22.64

UNIT	TOTALS
Material:	
Freight:	
Tax:	
Fee / Fuel:	
Other Chrg: No	

Today Tons:	863.69	Loads:
Tons To Date:	9,160.69	34
Today Tonnes	783.53	
Tonnes To Date:	8,310.44	

Carrier : 8040648 GJ SCOTT LLC
Vehicle: GS4 GS4
License: AJ118L
MaxGVW: 80,000

By acceptance of this ticket (with or without signature), driver accepts on behalf of themselves/their employer sole responsibility to ensure that the load received is within the weight limit authorized by law and shall hold seller harmless against any and all claims with respect to same CURB DELIVERY ONLY. NOT RESPONSIBLE FOR ANY DAMAGE BEYOND CURB.

Received: _____

Cust: _____

Weighmaster: Colleen LeSage

P/D Status: Deliver

Customer Copy Scale: 1



Plant: 32411

Berlin
368 New Brooklyn Road
Berlin, NJ 08009
856-809-0142, -

3/23/2017 12:09 In:
Customer: 8638404 THE AMBIENT GROUP LLC
Order : 950949 Camden, NJ. ABC Barrel Project
P.O. :

Tkt. No. 1006027792

Product 114203
Bank Run
S.O. Info: Camden, NJ.
Ship Ref: 327 N. Front St



	Pounds	Kilo
Gross	78,060	35,407
Tare	28,400 *	12,882
Net	49,660	22,525

24.83 Ton 22.53
* Predetermined Tare

	UNIT	TOTALS
Material:		
Freight:		
Tax:		
Fee / Fuel:		
Other Chrg: No		

Today Tons:	888.52	Loads:
Tons To Date:	9,185.52	35
Today Tonnes	806.05	
Tonnes To Date:	8,332.96	

Carrier : 8040648 GJ SCOTT LLC
Vehicle: GS17 GS17
License: AT640K
MaxGVW: 80,000

By acceptance of this ticket (with or without signature), driver accepts on behalf of themselves/their employer sole responsibility to ensure that the load received is within the weight limit authorized by law and shall hold seller harmless against any and all claims with respect to same CURB DELIVERY ONLY. NOT RESPONSIBLE FOR ANY DAMAGE BEYOND CURB.

Received: _____
Weighmaster: Colleen LeSage

Cust: _____

P/D Status: Deliver

Customer Do Not Accept [2] Scale: 1



Plant: 32411

Berlin
368 New Brooklyn Road
Berlin, NJ 08009
856-809-0142, -

3/23/2017 12:11 In: 11:49:30
Customer: 8638404 THE AMBIENT GROUP LLC
Order : 950949 Camden, NJ. ABC Barrel Project
P.O. :

Tkt. No. 1006027793

Product 114203
Bank Run
S.O. Info: Camden, NJ.
Ship Ref: 327 N. Front St



	Pounds	Kilo
Gross	77,600	35,199
Tare	26,600	12,066
Net	51,000	23,133

25.50 Ton 23.13

	UNIT	TOTALS
Material:		
Freight:		
Tax:		
Fee / Fuel:		
Other Chrg: No		

Today Tons:	914.02	Loads:
Tons To Date:	9,211.02	36
Today Tonnes	829.18	
Tonnes To Date:	8,356.10	

Carrier : 2347198 RAIO CONTRACTING & MATE
Vehicle: RO215 AH264S
License: AH264S
MaxGVW: 80,000

By acceptance of this ticket (with or without signature), driver accepts on behalf of themselves/their employer sole responsibility to ensure that the load received is within the weight limit authorized by law and shall hold seller harmless against any and all claims with respect to same CURB DELIVERY ONLY. NOT RESPONSIBLE FOR ANY DAMAGE BEYOND CURB.

Received: _____
Weighmaster: Colleen LeSage

Cust: _____

P/D Status: Deliver

Customer Copy Scale: 1



Plant: 32411

Berlin
368 New Brooklyn Road
Berlin, NJ 08009
856-809-0142

3/23/2017 12:24 In:
Customer: 8638404 THE AMBIENT GROUP LLC
Order : 950949 Camden, NJ. ABC Barrel Project
P.O. :

Tkt. No. 1006027798

Product 114203
Bank Run
S.O. Info: Camden, NJ.
Ship Ref: 327 N. Front St



	Pounds	Kilo
Gross	76,240	34,582
Tare	24,580 *	11,149
Net	51,660	23,433

25.83 Ton 23.43
* Predetermined Tare

	UNIT	TOTALS
Material:		
Freight:		
Tax:		
Fee / Fuel:		
Other Chrg: No		

Today Tons:	939.85	Loads:
Tons To Date:	9,236.85	37
Today Tonnes	852.62	
Tonnes To Date:	8,379.53	

Carrier : 2346970 GEORGE LAZOS TRUCKING
Vehicle: LG004 AP213T
License: LG004
MaxGVW: 80,000

By acceptance of this ticket (with or without signature), driver accepts on behalf of themselves/their employer sole responsibility to ensure that the load received is within the weight limit authorized by law and shall hold seller harmless against any and all claims with respect to same CURB DELIVERY ONLY. NOT RESPONSIBLE FOR ANY DAMAGE BEYOND CURB.

Received: _____
Weighmaster: Colleen LeSage

Cust: _____

P/D Status: Deliver

Customer Copy

Scale: 1



Plant: 32411

Berlin
368 New Brooklyn Road
Berlin, NJ 08009
856-809-0142

3/23/2017 12:26 In:
Customer: 8638404 THE AMBIENT GROUP LLC
Order : 950949 Camden, NJ. ABC Barrel Project
P.O. :

Tkt. No. 1006027798

Product 114203
Bank Run
S.O. Info: Camden, NJ.
Ship Ref: 327 N. Front St



	Pounds	Kilo
Gross	79,700	36,151
Tare	25,820 *	11,712
Net	53,880	24,440

26.94 Ton 24.44
* Predetermined Tare

	UNIT	TOTALS
Material:		
Freight:		
Tax:		
Fee / Fuel:		
Other Chrg: No		

Today Tons:	966.79	Loads:
Tons To Date:	9,263.79	38
Today Tonnes	877.06	
Tonnes To Date:	8,403.97	

Carrier : 8647386 TURKEYROOST TRANSPORT
Vehicle: TUR001 Turkeyroost
License: AP182A
MaxGVW: 80,000

By acceptance of this ticket (with or without signature), driver accepts on behalf of themselves/their employer sole responsibility to ensure that the load received is within the weight limit authorized by law and shall hold seller harmless against any and all claims with respect to same CURB DELIVERY ONLY. NOT RESPONSIBLE FOR ANY DAMAGE BEYOND CURB.

Received: _____
Weighmaster: Colleen LeSage

Cust: _____

P/D Status: Deliver

Customer Copy

Scale: 1



Plant: 32411

Berlin

368 New Brooklyn Road
Berlin, NJ 08009
856-809-0142

3/23/2017 12:35 In: 12:14:05
Customer: 8638404 THE AMBIENT GROUP LLC
Order: 950949 Camden, NJ. ABC Barrel Project
P.O.:

Tkt. No. 1006027802

Product 114203
Bank Run
S.O. Info: Camden, NJ.
Ship Ref: 327 N. Front St



	Pounds	Kilo
Gross	76,280	34,600
Tare	25,120	11,394
Net	51,160	23,206
	25.58 Ton	23.21

	UNIT	TOTALS
Material:		
Freight:		
Tax:		
Fee / Fuel:		
Other Chrg: No		

Today Tons:	992.37	Loads:
Tons To Date:	9,289.37	39
Today Tonnes	900.26	
Tonnes To Date:	8,427.17	

Carrier: 2347198 RAIO CONTRACTING & MATE
Vehicle: RO207 AT303G
License: AT303G
MaxGVW: 80,000

By acceptance of this ticket (with or without signature), driver accepts on behalf of themselves/their employer sole responsibility to ensure that the load received is within the weight limit authorized by law and shall hold seller harmless against any and all claims with respect to same CURB DELIVERY ONLY. NOT RESPONSIBLE FOR ANY DAMAGE BEYOND CURB.

Received: _____
Weighmaster: Colleen LeSage
P/D Status: Deliver

Cust: _____

Customer Copy Scale: 1



Plant: 32411

368 New Brooklyn Road
Berlin, NJ 08009
856-809-0142

3/23/2017 12:36 In: 12:14:18
Customer: 8638404 THE AMBIENT GROUP LLC
Order: 950949 Camden, NJ. ABC Barrel Project
P.O.:

Tkt. No. 1006027803

Product 114203
Bank Run
S.O. Info: Camden, NJ.
Ship Ref: 327 N. Front St

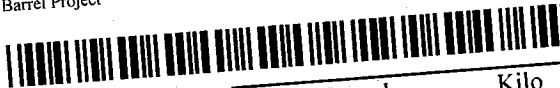

	Pounds	Kilo
Gross	76,480	34,691
Tare	24,800	11,249
Net	51,680	23,442
	25.84 Ton	23.44

	UNIT	TOTALS
Material:		
Freight:		
Tax:		
Fee / Fuel:		
Other Chrg: No		

Today Tons:	1,018.21	Loads:
Tons To Date:	9,315.21	40
Today Tonnes	923.70	
Tonnes To Date:	8,450.62	

Carrier: 2347198 RAIO CONTRACTING & MATE
Vehicle: RO222 AK269E
License: AK269e
MaxGVW: 80,000

By acceptance of this ticket (with or without signature), driver accepts on behalf of themselves/their employer sole responsibility to ensure that the load received is within the weight limit authorized by law and shall hold seller harmless against any and all claims with respect to same CURB DELIVERY ONLY. NOT RESPONSIBLE FOR ANY DAMAGE BEYOND CURB.

Received: _____
Weighmaster: Colleen LeSage
P/D Status: Deliver

Cust: _____

Customer Copy Scale: 1



Plant: 32411

Berlin

368 New Brooklyn Road
Berlin, NJ 08009
856-809-0142

3/23/2017 12:40 In :
Customer: 8638404 THE AMBIENT GROUP LLC
Order : 950949 Camden, NJ. ABC Barrel Project
P.O. :

Tkt. No. 1006027804

Product 114203
Bank Run
S.O. Info: Camden, NJ.
Ship Ref: 327 N. Front St



	Pounds	Kilo
Gross	78,620	35,661
Tare	26,260 *	11,911
Net	52,360	23,750

26.18 Ton 23.75
* Predetermined Tare

	UNIT	TOTALS
Material:		
Freight:		
Tax:		
Fee / Fuel:		
Other Chrg: No		

Today Tons:	1,044.39	Loads:
Tons To Date:	9,341.39	41
Today Tonnes	947.45	
Tonnes To Date:	8,474.37	

Carrier : 2347032 ROCKY LOGIOVINO TRUCKIN
Vehicle: LR060 Rocky
License: AM637B
MaxGVW: 80,000

By acceptance of this ticket (with or without signature), driver accepts on behalf of themselves/their employer sole responsibility to ensure that the load received is within the weight limit authorized by law and shall holdseller harmless against any and all claims with respect to same CURB DELIVERY ONLY. NOT RESPONSIBLE FOR ANY DAMAGE BEYOND CURB.

Received: _____
Weighmaster: Colleen LeSage

Cust: _____

P/D Status: Deliver

Customer Copy

Scale: 1



Plant: 32411

Berlin

368 New Brooklyn Road
Berlin, NJ 08009
856-809-0142

3/23/2017 12:44 In :
Customer: 8638404 THE AMBIENT GROUP LLC
Order : 950949 Camden, NJ. ABC Barrel Project
P.O. :

Tkt. No. 1006027805

Product 114203
Bank Run
S.O. Info: Camden, NJ.
Ship Ref: 327 N. Front St



	Pounds	Kilo
Gross	77,820	35,299
Tare	24,440 *	11,086
Net	53,380	24,213

26.69 Ton 24.21
* Predetermined Tare

	UNIT	TOTALS
Material:		
Freight:		
Tax:		
Fee / Fuel:		
Other Chrg: No		

Today Tons:	1,071.08	Loads:
Tons To Date:	9,368.08	42
Today Tonnes	971.67	
Tonnes To Date:	8,498.58	

Carrier : 8540415 S CUMMINS LLC
Vehicle: CUM17 Steve
License: AT979F
MaxGVW: 80,000

By acceptance of this ticket (with or without signature), driver accepts on behalf of themselves/their employer sole responsibility to ensure that the load received is within the weight limit authorized by law and shall holdseller harmless against any and all claims with respect to same CURB DELIVERY ONLY. NOT RESPONSIBLE FOR ANY DAMAGE BEYOND CURB.

Received:  Cust: _____
Weighmaster: Colleen LeSage

P/D Status: Deliver

Customer Copy

Scale: 1



Plant: 32411

Berlin

368 New Brooklyn Road
Berlin, NJ 08009
856-809-0142

3/23/2017 12:46

In :

Customer: 8638404 THE AMBIENT GROUP LLC

Order : 950949 Camden, NJ. ABC Barrel Project

P.O. :

Tkt. No. 1006027806

Product 114203

Bank Run

S.O. Info: Camden, NJ.

Ship Ref: 327 N. Front St



	Pounds	Kilo
Gross	77,560	35,181
Tare	29,080 *	13,190
Net	48,480	21,990

24.24 Ton 21.99

* Predetermined Tare

Today Tons:	1,095.32	Loads:
Tons To Date:	9,392.32	43
Today Tonnes	993.66	
Tonnes To Date:	8,520.57	

	UNIT	TOTALS
Material:		
Freight:		
Tax:		
Fee / Fuel:		
Other Chrg:	No	

Carrier : 9109539 VML TRUCKING2 LLC

Vehicle: VML102 XASG14

License: XASG14

MaxGVW: 80,000

Received:

Weighmaster: Colleen LeSage

Cust: _____

P/D Status: Deliver

Customer Copy

Scale: 1

By acceptance of this ticket (with or without signature), driver accepts on behalf of themselves/their employer sole responsibility to ensure that the load received is within the weight limit authorized by law and shall hold seller harmless against any and all claims with respect to same CURB DELIVERY ONLY. NOT RESPONSIBLE FOR ANY DAMAGE BEYOND CURB.



Plant: 32411

Berlin

368 New Brooklyn Road
Berlin, NJ 08009
856-809-0142

3/23/2017 13:19

In :

Customer: 8638404 THE AMBIENT GROUP LLC

Order : 950949 Camden, NJ. ABC Barrel Project

P.O. :

Tkt. No. 1006027808

Product 114203

Bank Run

S.O. Info: Camden, NJ.

Ship Ref: 327 N. Front St



	Pounds	Kilo
Gross	75,660	34,319
Tare	23,440 *	10,632
Net	52,220	23,687

26.11 Ton 23.69

* Predetermined Tare

Today Tons:	1,121.43	Loads:
Tons To Date:	9,418.43	44
Today Tonnes	1,017.34	
Tonnes To Date:	8,544.26	

	UNIT	TOTALS
Material:		
Freight:		
Tax:		
Fee / Fuel:		
Other Chrg:	No	

Carrier : 8515471 CALLE TRUCKING LLC

Vehicle: CALLE9 Grey truck

License: AG07469

MaxGVW: 80,000

Received:

Weighmaster: Colleen LeSage

Cust: _____

P/D Status: Deliver

Customer Copy

Scale: 1

By acceptance of this ticket (with or without signature), driver accepts on behalf of themselves/their employer sole responsibility to ensure that the load received is within the weight limit authorized by law and shall hold seller harmless against any and all claims with respect to same CURB DELIVERY ONLY. NOT RESPONSIBLE FOR ANY DAMAGE BEYOND CURB.



Plant: 32411

Berlin

368 New Brooklyn Road
Berlin, NJ 08009
856-809-0142

3/23/2017 13:24

In :

Customer: 8638404 THE AMBIENT GROUP LLC

Order : 950949 Camden, NJ. ABC Barrel Project

P.O. :

Tkt. No. 1006027810

Product 114203

Bank Run

S.O. Info: Camden, NJ.

Ship Ref: 327 N. Front St



	Pounds	Kilo
Gross	78,600	35,652
Tare	28,620 *	12,982
Net	49,980	22,671

24.99 Ton 22.67

* Predetermined Tare

Today Tons:	1,146.42	Loads:
Tons To Date:	9,443.42	45
Today Tonnes	1,040.01	
Tonnes To Date:	8,566.93	

	UNIT	TOTALS
Material:		
Freight:		
Tax:		
Fee / Fuel:		
Other Chrg:	No	

By acceptance of this ticket (with or without signature), driver accepts on behalf of themselves/their employer sole responsibility to ensure that the load received is within the weight limit authorized by law and shall hold seller harmless against any and all claims with respect to same CURB DELIVERY ONLY. NOT RESPONSIBLE FOR ANY DAMAGE BEYOND CURB.

Carrier : 8040648 GJ SCOTT LLC

Vehicle: GS15 GS15

License: AS672T

MaxGVW: 80,000

Received:

Weighmaster: Colleen LeSage

Cust: _____

P/D Status: Deliver

Customer Copy

Scale: 1



Plant: 32411

Berlin

368 New Brooklyn Road
Berlin, NJ 08009
856-809-0142

3/23/2017 13:26

In :

Customer: 8638404 THE AMBIENT GROUP LLC

Order : 950949 Camden, NJ. ABC Barrel Project

P.O. :

Tkt. No. 1006027811

Product 114203

Bank Run

S.O. Info: Camden, NJ.

Ship Ref: 327 N. Front St



	Pounds	Kilo
Gross	79,960	36,269
Tare	28,080 *	12,737
Net	51,880	23,532

25.94 Ton 23.53

* Predetermined Tare

Today Tons:	1,172.36	Loads:
Tons To Date:	9,469.36	46
Today Tonnes	1,063.55	
Tonnes To Date:	8,590.46	

	UNIT	TOTALS
Material:		
Freight:		
Tax:		
Fee / Fuel:		
Other Chrg:	No	

By acceptance of this ticket (with or without signature), driver accepts on behalf of themselves/their employer sole responsibility to ensure that the load received is within the weight limit authorized by law and shall hold seller harmless against any and all claims with respect to same CURB DELIVERY ONLY. NOT RESPONSIBLE FOR ANY DAMAGE BEYOND CURB.

Carrier : 8040648 GJ SCOTT LLC

Vehicle: GS16 GS16

License: AT639K

MaxGVW: 80,000

Received:

Weighmaster: Colleen LeSage

Cust: _____

P/D Status: Deliver

Customer Copy

Scale: 1



Plant: 32411

Berlin
368 New Brooklyn Road
Berlin, NJ 08009
856-809-0142

3/23/2017 13:29 In :
Customer: 8638404 THE AMBIENT GROUP LLC
Order : 950949 Camden, NJ. ABC Barrel Project
P.O. :

Tkt. No. 1006027812

Product 114203
Bank Run
S.O. Info: Camden, NJ.
Ship Ref: 327 N. Front St



	Pounds	Kilo
Gross	78,780	35,734
Tare	28,400 *	12,882
Net	50,380	22,852
	25.19 Ton	22.85

* Predetermined Tare

UNIT	TOTALS
Material:	
Freight:	
Tax:	
Fee / Fuel:	
Other Chrg: <u>No</u>	

Today Tons:	1,197.55	Loads:	
Tons To Date:	9,494.55		47
Today Tonnes	1,086.40		
Tonnes To Date:	8,613.31		

By acceptance of this ticket (with or without signature), driver accepts on behalf of themselves/their employer sole responsibility to ensure that the load received is within the weight limit authorized by law and shall hold seller harmless against any and all claims with respect to same
CURB DELIVERY ONLY. NOT RESPONSIBLE FOR ANY DAMAGE BEYOND CURB.

Carrier : 8040648 GJ SCOTT LLC
Vehicle: GS17 GS17
License: **AT640K**
MaxGVW: 80,000
Received: _____

Cust: _____

Weighmaster: Colleen LeSage

P/D Status: **Deliver**

Customer Do Not Accept [2] Scale: 1



Plant: 32411

Berlin
368 New Brooklyn Road
Berlin, NJ 08009
856-809-0142

3/23/2017 13:47 In :
Customer: 8638404 THE AMBIENT GROUP LLC
Order : 950949 Camden, NJ. ABC Barrel Project
P.O. :

Tkt. No. 1006027816

Product 114203
Bank Run
S.O. Info: Camden, NJ.
Ship Ref: 327 N. Front St



	Pounds	Kilo
Gross	77,180	35,008
Tare	27,880 *	12,646
Net	49,300	22,362
	24.65 Ton	22.36

* Predetermined Tare

UNIT	TOTALS
Material:	
Freight:	
Tax:	
Fee / Fuel:	
Other Chrg: <u>No</u>	

Today Tons:	1,222.20	Loads:	
Tons To Date:	9,519.20		48
Today Tonnes	1,108.76		
Tonnes To Date:	8,635.67		

By acceptance of this ticket (with or without signature), driver accepts on behalf of themselves/their employer sole responsibility to ensure that the load received is within the weight limit authorized by law and shall hold seller harmless against any and all claims with respect to same
CURB DELIVERY ONLY. NOT RESPONSIBLE FOR ANY DAMAGE BEYOND CURB.

Carrier : 8040648 GJ SCOTT LLC
Vehicle: GS4 GS4
License: **AJ118L**
MaxGVW: 80,000
Received: _____

Cust: _____

Weighmaster: Colleen LeSage

P/D Status: **Deliver**

Customer Copy Scale: 1



Plant: 32411

Berlin

368 New Brooklyn Road
Berlin, NJ 08009
856-809-0142

3/23/2017 13:48

In:

Customer: 8638404 THE AMBIENT GROUP LLC

Order : 950949 Camden, NJ. ABC Barrel Project

Tkt. No. 1006027817

P.O. :



Product 114203

Bank Run

S.O. Info: Camden, NJ.

Ship Ref: 327 N. Front St

	Pounds	Kilo
Gross	75,900	34,428
Tare	24,580 *	11,149
Net	51,320	23,278

25.66 Ton 23.28

* Predetermined Tare

	UNIT	TOTALS
Material:		
Freight:		
Tax:		
Fee / Fuel:		
Other Chrg:	No	

Today Tons:	1,247.86	Loads:
Tons To Date:	9,544.86	49
Today Tonnes	1,132.04	
Tonnes To Date:	8,658.95	

Carrier : 2346970 GEORGE LAZOS TRUCKING

Vehicle: LG004 AP213T

License: LG004

MaxGVW: 80,000

Received: _____

Cust: _____

Weighmaster: Colleen LeSage

P/D Status: Deliver

By acceptance of this ticket (with or without signature), driver accepts on behalf of themselves/their employer sole responsibility to ensure that the load received is within the weight limit authorized by law and shall hold self harmless against any and all claims with respect to same CURB DELIVERY ONLY. NOT RESPONSIBLE FOR ANY DAMAGE BEYOND CURB.

Customer Copy

Scale: 1



Plant: 32411

Berlin

368 New Brooklyn Road
Berlin, NJ 08009
856-809-0142

3/24/2017 07:12

In: 6:38:55

Customer: 8638404 THE AMBIENT GROUP LLC

Order: 950949 Camden, NJ. ABC Barrel Project

P.O.:

Tkt. No. 1006027822



Product 114203

Bank Run

S.O. Info: Camden, NJ.

Ship Ref: 327 N. Front St

	Pounds	Kilo
Gross	79,360	35,997
Tare	25,820	11,712
Net	53,540	24,285

26.77 Ton 24.29

Material:	UNIT	TOTALS
Freight:		
Tax:		
Fee / Fuel:		
Other Chrg: No		

Today Tons:	26.77	Loads:
Tons To Date:	9,571.63	1
Today Tonnes	24.29	
Tonnes To Date:	8,683.24	

Carrier: 8647386 TURKEYROOST TRANSPORT

Vehicle: TUR001 Turkeyroost

License: AP182A

MaxGVW: 80,000

Received:

Weighmaster: Colleen LeSage

Cust:

P/D Status: Deliver

By acceptance of this ticket (with or without signature), driver accepts on behalf of themselves/their employer sole responsibility to ensure that the load received is within the weight limit authorized by law and shall hold seller harmless against any and all claims with respect to same
CURB DELIVERY ONLY. NOT RESPONSIBLE FOR ANY DAMAGE BEYOND CURB.

Customer Do Not Accept [1] Scale: 1



Plant: 32411

Berlin

368 New Brooklyn Road
Berlin, NJ 08009
856-809-0142

3/24/2017 07:26

In:

Customer: 8638404 THE AMBIENT GROUP LLC

Order: 950949 Camden, NJ. ABC Barrel Project

P.O.:

Tkt. No. 1006027826



Product 114203

Bank Run

S.O. Info: Camden, NJ.

Ship Ref: 327 N. Front St

	Pounds	Kilo
Gross	79,620 m	36,115
Tare	28,760 *	13,045
Net	50,860 m	23,070

25.43 Ton 23.07
m Manual Weight, * P.T.

Material:	UNIT	TOTALS
Freight:		
Tax:		
Fee / Fuel:		
Other Chrg: No		

Today Tons:	52.20	Loads:
Tons To Date:	9,597.06	2
Today Tonnes	47.36	
Tonnes To Date:	8,706.31	

Carrier: 8040648 GJ SCOTT LLC

Vehicle: GS14 GS14

License: As672T

MaxGVW: 80,000

Received:

Weighmaster: Colleen LeSage

Cust:

P/D Status: Deliver

By acceptance of this ticket (with or without signature), driver accepts on behalf of themselves/their employer sole responsibility to ensure that the load received is within the weight limit authorized by law and shall hold seller harmless against any and all claims with respect to same
CURB DELIVERY ONLY. NOT RESPONSIBLE FOR ANY DAMAGE BEYOND CURB.

Customer Do Not Accept [2] Scale: 3



Plant: 32411

Berlin

368 New Brooklyn Road
Berlin, NJ 08009
856-809-0142

3/24/2017 07:27 In: 6:43:23
Customer: 8638404 THE AMBIENT GROUP LLC
Order : 950949 Camden, NJ. ABC Barrel Project
P.O. :

Tkt. No. 1006027827

Product 114203
Bank Run
S.O. Info: Camden, NJ.
Ship Ref: 327 N. Front St



	Pounds	Kilo
Gross	77,780	35,280
Tare	28,060	12,728
Net	49,720	22,553
	24.86 Ton	22.55

	UNIT	TOTALS
Material:		
Freight:		
Tax:		
Fee / Fuel:		
Other Chrg:	No	

Today Tons:	77.06	Loads:
Tons To Date:	9,621.92	3
Today Tonnes	69.91	
Tonnes To Date:	8,728.86	

Carrier : 8040648 GJ SCOTT LLC
Vehicle: GS16 GS16
License: AT639K
MaxGVW: 80,000

By acceptance of this ticket (with or without signature), driver accepts on behalf of themselves/their employer sole responsibility to ensure that the load received is within the weight limit authorized by law and shall holdseller harmless against any and all claims with respect to same CURB DELIVERY ONLY. NOT RESPONSIBLE FOR ANY DAMAGE BEYOND CURB.

Received: _____
Weighmaster: Colleen LeSage

Cust: _____

P/D Status: Deliver

Customer Copy

Scale: 1



Plant: 32411

Berlin

368 New Brooklyn Road
Berlin, NJ 08009
856-809-0142

3/24/2017 07:30 In: 6:43:50
Customer: 8638404 THE AMBIENT GROUP LLC
Order : 950949 Camden, NJ. ABC Barrel Project
P.O. :

Tkt. No. 1006027828

Product 114203
Bank Run
S.O. Info: Camden, NJ.
Ship Ref: 327 N. Front St



	Pounds	Kilo
Gross	79,220	35,934
Tare	28,840	13,082
Net	50,380	22,852
	25.19 Ton	22.85

	UNIT	TOTALS
Material:		
Freight:		
Tax:		
Fee / Fuel:		
Other Chrg:	No	

Today Tons:	102.25	Loads:
Tons To Date:	9,647.11	4
Today Tonnes	92.76	
Tonnes To Date:	8,751.71	

Carrier : 8040648 GJ SCOTT LLC
Vehicle: GS15 GS15
License: AS672T
MaxGVW: 80,000

By acceptance of this ticket (with or without signature), driver accepts on behalf of themselves/their employer sole responsibility to ensure that the load received is within the weight limit authorized by law and shall holdseller harmless against any and all claims with respect to same CURB DELIVERY ONLY. NOT RESPONSIBLE FOR ANY DAMAGE BEYOND CURB.

Received: _____
Weighmaster: Colleen LeSage

Cust: _____

P/D Status: Deliver

Customer Copy

Scale: 1



Plant: 32411

Berlin

368 New Brooklyn Road
Berlin, NJ 08009
856-809-0142

3/24/2017 07:32 In: 6:44:12
Customer: 8638404 THE AMBIENT GROUP LLC
Order: 950949 Camden, NJ. ABC Barrel Project
P.O.:

Tkt. No. 1006027829

Product 114203
Bank Run
S.O. Info: Camden, NJ
Ship Ref: 327 N. Front St



	Pounds	Kilo
Gross	78,480	35,598
Tare	28,380	12,873
Net	50,100	22,725

25.05 Ton 22.72

	UNIT	TOTALS
Material:		
Freight:		
Tax:		
Fee / Fuel:		
Other Chrg: No		

Today Tons:	127.30	Loads:
Tons To Date:	9,672.16	5
Today Tonnes	115.48	
Tonnes To Date:	8,774.44	

Carrier: 8040648 GJ SCOTT LLC
Vehicle: GS17 GS17
License: AT640K
MaxGVW: 80,000

By acceptance of this ticket (with or without signature), driver accepts on behalf of themselves/their employer sole responsibility to ensure that the load received is within the weight limit authorized by law and shall hold seller harmless against any and all claims with respect to same
CURB DELIVERY ONLY. NOT RESPONSIBLE FOR ANY DAMAGE BEYOND CURB.

Received: _____
Weighmaster: Colleen LeSage

Cust: _____

P/D Status: Deliver

Customer Copy

Scale: 1



Plant: 32411

Berlin

368 New Brooklyn Road
Berlin, NJ 08009
856-809-0142

3/24/2017 07:38 In: 6:47:39
Customer: 8638404 THE AMBIENT GROUP LLC
Order: 950949 Camden, NJ. ABC Barrel Project
P.O.:

Tkt. No. 1006027832

Product 114203
Bank Run
S.O. Info: Camden, NJ
Ship Ref: 327 N. Front St



	Pounds	Kilo
Gross	79,000	35,834
Tare	24,740	11,222
Net	54,260	24,612

27.13 Ton 24.61

	UNIT	TOTALS
Material:		
Freight:		
Tax:		
Fee / Fuel:		
Other Chrg: No		

Today Tons:	154.43	Loads:
Tons To Date:	9,699.29	6
Today Tonnes	140.10	
Tonnes To Date:	8,799.05	

Carrier: 8540415 S CUMMINS LLC
Vehicle: CUM17 Steve
License: AT979F
MaxGVW: 80,000

By acceptance of this ticket (with or without signature), driver accepts on behalf of themselves/their employer sole responsibility to ensure that the load received is within the weight limit authorized by law and shall hold seller harmless against any and all claims with respect to same
CURB DELIVERY ONLY. NOT RESPONSIBLE FOR ANY DAMAGE BEYOND CURB.

Received: 
Weighmaster: Colleen LeSage

Cust: _____

P/D Status: Deliver

Customer Copy

Scale: 1



Plant: 32411

Berlin

368 New Brooklyn Road
Berlin, NJ 08009
856-809-0142

3/24/2017 07:41 In: 6:51:12
Customer: 8638404 THE AMBIENT GROUP LLC
Order : 950949 Camden, NJ. ABC Barrel Project
P.O. :

Tkt. No. 1006027833

Product 114203
Bank Run
S.O. Info: Camden, NJ.
Ship Ref: 327 N. Front St



	Pounds	Kilo
Gross	79,400	36,015
Tare	27,720	12,574
Net	51,680	23,442
	25.84 Ton	23.44

	UNIT	TOTALS
Material:		
Freight:		
Tax:		
Fee / Fuel:		
Other Chrg: No		

Today Tons:	180.27	Loads:
Tons To Date:	9,725.13	7
Today Tonnes	163.54	
Tonnes To Date:	8,822.49	

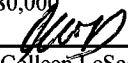
Carrier : 3804135 MOD HAULING SERVICES
Vehicle: MOD105 MOD Hauling Services
License: AT496J
MaxGVW: 80,000
Received: 
Weighmaster: Colleen LeSage

By acceptance of this ticket (with or without signature), driver accepts on behalf of themselves/their employer sole responsibility to ensure that the load received is within the weight limit authorized by law and shall hold seller harmless against any and all claims with respect to same CURB DELIVERY ONLY. NOT RESPONSIBLE FOR ANY DAMAGE BEYOND CURB.

Cust: _____

P/D Status: Deliver

Customer Copy

Scale: 1



Plant: 32411

Berlin

368 New Brooklyn Road
Berlin, NJ 08009
856-809-0142

3/24/2017 07:43 In: 6:52:10
Customer: 8638404 THE AMBIENT GROUP LLC
Order : 950949 Camden, NJ. ABC Barrel Project
P.O. :

Tkt. No. 1006027834

Product 114203
Bank Run
S.O. Info: Camden, NJ.
Ship Ref: 327 N. Front St

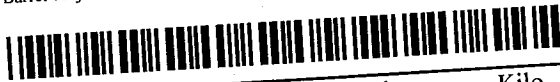

	Pounds	Kilo
Gross	78,680	35,689
Tare	24,600	11,158
Net	54,080	24,530
	27.04 Ton	24.53

	UNIT	TOTALS
Material:		
Freight:		
Tax:		
Fee / Fuel:		
Other Chrg: No		

Today Tons:	207.31	Loads:
Tons To Date:	9,752.17	8
Today Tonnes	188.07	
Tonnes To Date:	8,847.02	

Carrier : 2346970 GEORGE LAZOS TRUCKING
Vehicle: LG004 AP213T
License: LG004
MaxGVW: 80,000
Received: _____
Weighmaster: Colleen LeSage

By acceptance of this ticket (with or without signature), driver accepts on behalf of themselves/their employer sole responsibility to ensure that the load received is within the weight limit authorized by law and shall hold seller harmless against any and all claims with respect to same CURB DELIVERY ONLY. NOT RESPONSIBLE FOR ANY DAMAGE BEYOND CURB.

Cust: _____

P/D Status: Deliver

Customer Copy

Scale: 1



Plant: 32411

Berlin

368 New Brooklyn Road
Berlin, NJ 08009
856-809-0142

3/24/2017 07:45

In: 6:49:25

Customer: 8638404 THE AMBIENT GROUP LLC

Order: 950949 Camden, NJ. ABC Barrel Project

P.O.:

Tkt. No. 1006027835

Product 114203

Bank Run

S.O. Info: Camden, NJ.

Ship Ref: 327 N. Front St



	Pounds	Kilo
Gross	79,840	36,215
Tare	26,640	12,084
Net	53,200	24,131

26.60 Ton 24.13

	UNIT	TOTALS
Material:		
Freight:		
Tax:		
Fee / Fuel:		
Other Chrg:	No	

Today Tons:	233.91	Loads:
Tons To Date:	9,778.77	9
Today Tonnes	212.20	
Tonnes To Date:	8,871.15	

Carrier: 2347032 ROCKY LOGIOVINO TRUCKIN

Vehicle: LR060 Rocky

License: AM637B

MaxGVW: 80,000

Received:

Weighmaster: Colleen LeSage

P/D Status: Deliver

Cust: _____

By acceptance of this ticket (with or without signature), driver accepts on behalf of themselves/their employer sole responsibility to ensure that the load received is within the weight limit authorized by law and shall holdseller harmless against any and all claims with respect to same CURB DELIVERY ONLY. NOT RESPONSIBLE FOR ANY DAMAGE BEYOND CURB.

Customer Copy

Scale: 1



Plant: 32411

Berlin

368 New Brooklyn Road
Berlin, NJ 08009
856-809-0142

3/24/2017 07:51

In: 7:04:06

Customer: 8638404 THE AMBIENT GROUP LLC

Order: 950949 Camden, NJ. ABC Barrel Project

P.O.:

Tkt. No. 1006027837

Product 114203

Bank Run

S.O. Info: Camden, NJ.

Ship Ref: 327 N. Front St



	Pounds	Kilo
Gross	76,800	34,836
Tare	27,220	12,347
Net	49,580	22,489

24.79 Ton 22.49

	UNIT	TOTALS
Material:		
Freight:		
Tax:		
Fee / Fuel:		
Other Chrg:	No	

Today Tons:	258.70	Loads:
Tons To Date:	9,803.56	10
Today Tonnes	234.69	
Tonnes To Date:	8,893.64	

Carrier: 9285292 BLUESTONE CONTRACTING C

Vehicle: SB10 AT225C

License: AT225C

MaxGVW: 80,000

Received:

Weighmaster: Colleen LeSage

P/D Status: Deliver

Cust: _____

By acceptance of this ticket (with or without signature), driver accepts on behalf of themselves/their employer sole responsibility to ensure that the load received is within the weight limit authorized by law and shall holdseller harmless against any and all claims with respect to same CURB DELIVERY ONLY. NOT RESPONSIBLE FOR ANY DAMAGE BEYOND CURB.

Customer Copy

Scale: 1



Plant: 32411

Berlin

368 New Brooklyn Road
Berlin, NJ 08009
856-809-0142

3/24/2017 08:36

In :

Customer: 8638404 THE AMBIENT GROUP LLC

Order : 950949 Camden, NJ. ABC Barrel Project

P.O. :

Tkt. No. 1006027842

Product 114203

Bank Run

S.O. Info: Camden, NJ.

Ship Ref: 327 N. Front St



	Pounds	Kilo
Gross	79,620	36,115
Tare	25,820 *	11,712
Net	53,800	24,403

26.90 Ton 24.40

* Predetermined Tare

Material:	UNIT	TOTALS
Freight:		
Tax:		
Fee / Fuel:		
Other Chrg: No		

Today Tons:	285.60	Loads:
Tons To Date:	9,830.46	11
Today Tonnes	259.09	
Tonnes To Date:	8,918.04	

Carrier : 8647386 TURKEYROOST TRANSPORT

Vehicle: TUR001 Turkeyroost

License: AP182A

MaxGVW: 80,000

Received:

Cust:

Weighmaster: Colleen LeSage

P/D Status: Deliver

By acceptance of this ticket (with or without signature), driver accepts on behalf of themselves/their employer sole responsibility to ensure that the load received is within the weight limit authorized by law and shall hold seller harmless against any and all claims with respect to same CURB DELIVERY ONLY. NOT RESPONSIBLE FOR ANY DAMAGE BEYOND CURB.

Customer Do Not Accept [1] Scale: 1



Plant: 32411

Berlin

368 New Brooklyn Road
Berlin, NJ 08009
856-809-0142

3/24/2017 08:50

In : 8:34:14

Customer: 8638404 THE AMBIENT GROUP LLC

Order : 950949 Camden, NJ. ABC Barrel Project

P.O. :

Tkt. No. 1006027845

Product 114203

Bank Run

S.O. Info: Camden, NJ.

Ship Ref: 327 N. Front St



	Pounds	Kilo
Gross	77,500	35,153
Tare	24,680	11,195
Net	52,820	23,959

26.41 Ton 23.96

Material:	UNIT	TOTALS
Freight:		
Tax:		
Fee / Fuel:		
Other Chrg: No		

Today Tons:	312.01	Loads:
Tons To Date:	9,856.87	12
Today Tonnes	283.05	
Tonnes To Date:	8,942.00	

Carrier : 8515471 CALLE TRUCKING LLC

Vehicle: CALLE5 Calle Trucking

License: AF49921

MaxGVW: 80,000

Received:

Cust:

Weighmaster: Colleen LeSage

P/D Status: Deliver

By acceptance of this ticket (with or without signature), driver accepts on behalf of themselves/their employer sole responsibility to ensure that the load received is within the weight limit authorized by law and shall hold seller harmless against any and all claims with respect to same CURB DELIVERY ONLY. NOT RESPONSIBLE FOR ANY DAMAGE BEYOND CURB.

Customer Do Not Accept [2] Scale: 1



Plant: 32411

Berlin
368 New Brooklyn Road
Berlin, NJ 08009
856-809-0142, -

3/24/2017 08:55 In :
Customer: 8638404 THE AMBIENT GROUP LLC
Order : 950949 Camden, NJ. ABC Barrel Project
P.O. :

Tkt. No. 1006027846



Product 114203
Bank Run
S.O. Info: Camden, NJ.
Ship Ref: 327 N. Front St

	Pounds	Kilo
Gross	79,280	35,961
Tare	28,760 *	13,045
Net	50,520	22,915
25.26 Ton		22.92

* Predetermined Tare

	UNIT	TOTALS
Material:		
Freight:		
Tax:		
Fee / Fuel:		
Other Chrg: No		

Today Tons:	337.27	Loads:
Tons To Date:	9,882.13	13
Today Tonnes	305.97	
Tonnes To Date:	8,964.92	

By acceptance of this ticket (with or without signature), driver accepts on behalf of themselves/their employer sole responsibility to ensure that the load received is within the weight limit authorized by law and shall hold seller harmless against any and all claims with respect to same CURB DELIVERY ONLY. NOT RESPONSIBLE FOR ANY DAMAGE BEYOND CURB.

Carrier : 8040648 GJ SCOTT LLC
Vehicle: GS14 GS14
License: As672T
MaxGVW: 80,000
Received: _____
Weighmaster: Colleen LeSage

Cust: _____

P/D Status: Deliver

Customer Do Not Accept [2] Scale: 1



Plant: 32411

Berlin
368 New Brooklyn Road
Berlin, NJ 08009
856-809-0142, -

3/24/2017 08:56 In :
Customer: 8638404 THE AMBIENT GROUP LLC
Order : 950949 Camden, NJ. ABC Barrel Project
P.O. :

Tkt. No. 1006027847



Product 114203
Bank Run
S.O. Info: Camden, NJ.
Ship Ref: 327 N. Front St

	Pounds	Kilo
Gross	78,960	35,816
Tare	28,060 *	12,728
Net	50,900	23,088
25.45 Ton		23.09

* Predetermined Tare

	UNIT	TOTALS
Material:		
Freight:		
Tax:		
Fee / Fuel:		
Other Chrg: No		

Today Tons:	362.72	Loads:
Tons To Date:	9,907.58	14
Today Tonnes	329.05	
Tonnes To Date:	8,988.01	

By acceptance of this ticket (with or without signature), driver accepts on behalf of themselves/their employer sole responsibility to ensure that the load received is within the weight limit authorized by law and shall hold seller harmless against any and all claims with respect to same CURB DELIVERY ONLY. NOT RESPONSIBLE FOR ANY DAMAGE BEYOND CURB.

Carrier : 8040648 GJ SCOTT LLC
Vehicle: GS16 GS16
License: AT639K
MaxGVW: 80,000
Received: _____
Weighmaster: Colleen LeSage

Cust: _____

P/D Status: Deliver

Customer Do Not Accept [2] Scale: 1



Plant: 32411

Berlin
368 New Brooklyn Road
Berlin, NJ 08009
856-809-0142, -

3/24/2017 09:02 In:
Customer: 8638404 THE AMBIENT GROUP LLC
Order : 950949 Camden, NJ. ABC Barrel Project
P.O. :

Tkt. No. 1006027849



Product 114203
Bank Run
S.O. Info: Camden, NJ.
Ship Ref: 327 N. Front St

	Pounds	Kilo
Gross	79,380	36,006
Tare	28,840 *	13,082
Net	50,540	22,925
	25.27 Ton	22.92

* Predetermined Tare

UNIT	TOTALS
Material:	
Freight:	
Tax:	
Fee / Fuel:	
Other Chrg: No	

Today Tons:	387.99	Loads:
Tons To Date:	9,932.85	15
Today Tonnes	351.98	
Tonnes To Date:	9,010.93	

Carrier : 8040648 GJ SCOTT LLC
Vehicle: GS15 GS15
License: AS672T
MaxGVW: 80,000

By acceptance of this ticket (with or without signature), driver accepts on behalf of themselves/their employer sole responsibility to ensure that the load received is within the weight limit authorized by law and shall hold seller harmless against any and all claims with respect to same CURB DELIVERY ONLY. NOT RESPONSIBLE FOR ANY DAMAGE BEYOND CURB.

Received: _____
Weighmaster: Colleen LeSage

Cust: _____

P/D Status: Deliver

Customer Do Not Accept [2] Scale: 1



Plant: 32411

Berlin
368 New Brooklyn Road
Berlin, NJ 08009
856-809-0142, -

3/24/2017 09:04 In:
Customer: 8638404 THE AMBIENT GROUP LLC
Order : 950949 Camden, NJ. ABC Barrel Project
P.O. :

Tkt. No. 1006027850



Product 114203
Bank Run
S.O. Info: Camden, NJ.
Ship Ref: 327 N. Front St

	Pounds	Kilo
Gross	79,340	35,988
Tare	28,380 *	12,873
Net	50,960	23,115
	25.48 Ton	23.12

* Predetermined Tare

UNIT	TOTALS
Material:	
Freight:	
Tax:	
Fee / Fuel:	
Other Chrg: No	

Today Tons:	413.47	Loads:
Tons To Date:	9,958.33	16
Today Tonnes	375.09	
Tonnes To Date:	9,034.05	

By acceptance of this ticket (with or without signature), driver accepts on behalf of themselves/their employer sole responsibility to ensure that the load received is within the weight limit authorized by law and shall hold seller harmless against any and all claims with respect to same CURB DELIVERY ONLY. NOT RESPONSIBLE FOR ANY DAMAGE BEYOND CURB.

Carrier : 8040648 GJ SCOTT LLC
Vehicle: GS17 GS17
License: AT640K
MaxGVW: 80,000

Received: _____
Weighmaster: Colleen LeSage

Cust: _____

P/D Status: Deliver

Customer Copy Scale: 1



Plant: 32411

Berlin

368 New Brooklyn Road
Berlin, NJ 08009
856-809-0142

3/24/2017 09:07 In: 8:42:45
Customer: 8638404 THE AMBIENT GROUP LLC
Order: 950949 Camden, NJ. ABC Barrel Project
P.O.:

Tkt. No. 1006027851

Product 114203
Bank Run
S.O. Info: Camden, NJ.
Ship Ref: 327 N. Front St



	Pounds	Kilo
Gross	75,920	34,437
Tare	23,400	10,614
Net	52,520	23,823
	26.26 Ton	23.82

	UNIT	TOTALS
Material:		
Freight:		
Tax:		
Fee / Fuel:		
Other Chrg: No		

Today Tons:	439.73	Loads:
Tons To Date:	9,984.59	17
Today Tonnes	398.92	
Tonnes To Date:	9,057.87	

Carrier: 8515471 CALLE TRUCKING LLC
Vehicle: CALLE9 Grey truck
License: AG07469
MaxGVW: 80,000

By acceptance of this ticket (with or without signature), driver accepts on behalf of themselves/their employer sole responsibility to ensure that the load received is within the weight limit authorized by law and shall hold seller harmless against any and all claims with respect to same CURB DELIVERY ONLY. NOT RESPONSIBLE FOR ANY DAMAGE BEYOND CURB.

Received: [Signature]
Weighmaster: Colleen LeSage

Cust: _____

P/D Status: Deliver

Customer Copy

Scale: 1



Plant: 32411

Berlin

368 New Brooklyn Road
Berlin, NJ 08009
856-809-0142

3/24/2017 09:12 In:
Customer: 8638404 THE AMBIENT GROUP LLC
Order: 950949 Camden, NJ. ABC Barrel Project
P.O.:

Tkt. No. 1006027853

Product 114203
Bank Run
S.O. Info: Camden, NJ.
Ship Ref: 327 N. Front St



	Pounds	Kilo
Gross	78,360	35,543
Tare	24,740 *	11,222
Net	53,620	24,322
	26.81 Ton	24.32

	UNIT	TOTALS
Material:		
Freight:		
Tax:		
Fee / Fuel:		
Other Chrg: No		

Today Tons:	466.54	Loads:
Tons To Date:	10,011.40	18
Today Tonnes	423.24	
Tonnes To Date:	9,082.19	

Carrier: 8540415 S CUMMINS LLC
Vehicle: CUM17 Steve
License: AT979F
MaxGVW: 80,000

By acceptance of this ticket (with or without signature), driver accepts on behalf of themselves/their employer sole responsibility to ensure that the load received is within the weight limit authorized by law and shall hold seller harmless against any and all claims with respect to same CURB DELIVERY ONLY. NOT RESPONSIBLE FOR ANY DAMAGE BEYOND CURB.

Received: _____
Weighmaster: Colleen LeSage

Cust: _____

P/D Status: Deliver

Customer Do Not Accept [2]

Scale: 1



Plant: 32411

Berlin
368 New Brooklyn Road
Berlin, NJ 08009
856-809-0142

3/24/2017 09:14

In :

Customer: 8638404 THE AMBIENT GROUP LLC

Order : 950949 Camden, NJ. ABC Barrel Project

P.O. :

Tkt. No. 1006027854

Product 114203



Bank Run

S.O. Info: Camden, NJ.

Ship Ref: 327 N. Front St

	Pounds	Kilo
Gross	78,640	35,670
Tare	27,720 *	12,574
Net	50,920	23,097

25.46 Ton 23.10

* Predetermined Tare

	UNIT	TOTALS
Material:		
Freight:		
Tax:		
Fee / Fuel:		
Other Chrg: No		

Today Tons:	492.00	Loads:
Tons To Date:	10,036.86	19
Today Tonnes	446.33	
Tonnes To Date:	9,105.29	

Carrier : 3804135 MOD HAULING SERVICES

Vehicle: MOD105 MOD Hauling Services

License: AT496J

MaxGVW: 80,000

Received: 

Weighmaster: Colleen LeSage

Cust: _____

P/D Status: Deliver

Customer Do Not Accept [1] Scale: 1

By acceptance of this ticket (with or without signature), driver accepts on behalf of themselves/their employer sole responsibility to ensure that the load received is within the weight limit authorized by law and shall hold seller harmless against any and all claims with respect to same
CURB DELIVERY ONLY .NOT RESPONSIBLE FOR ANY DAMAGE BEYOND CURB.



Plant: 32411

Berlin
368 New Brooklyn Road
Berlin, NJ 08009
856-809-0142

3/24/2017 09:17

In :

Customer: 8638404 THE AMBIENT GROUP LLC

Order : 950949 Camden, NJ. ABC Barrel Project

P.O. :

Tkt. No. 1006027855

Product 114203



Bank Run

S.O. Info: Camden, NJ.

Ship Ref: 327 N. Front St

	Pounds	Kilo
Gross	78,640	35,670
Tare	24,600 *	11,158
Net	54,040	24,512

27.02 Ton 24.51

* Predetermined Tare

	UNIT	TOTALS
Material:		
Freight:		
Tax:		
Fee / Fuel:		
Other Chrg: No		

Today Tons:	519.02	Loads:
Tons To Date:	10,063.88	20
Today Tonnes	470.85	
Tonnes To Date:	9,129.80	

Carrier : 2346970 GEORGE LAZOS TRUCKING

Vehicle: LG004 AP213T

License: LG004

MaxGVW: 80,000

Received: _____

Weighmaster: Colleen LeSage

Cust: _____

P/D Status: Deliver

Customer Copy Scale: 1

By acceptance of this ticket (with or without signature), driver accepts on behalf of themselves/their employer sole responsibility to ensure that the load received is within the weight limit authorized by law and shall hold seller harmless against any and all claims with respect to same
CURB DELIVERY ONLY .NOT RESPONSIBLE FOR ANY DAMAGE BEYOND CURB.



Plant: 32411

Berlin

368 New Brooklyn Road
Berlin, NJ 08009
856-809-0142

3/24/2017 09:25 In :
Customer: 8638404 THE AMBIENT GROUP LLC
Order : 950949 Camden, NJ. ABC Barrel Project
P.O. :

Tkt. No. 1006027857

Product 114203
Bank Run
S.O. Info: Camden, NJ
Ship Ref: 327 N. Front St



	Pounds	Kilo
Gross	78,860	35,770
Tare	26,640 *	12,084
Net	52,220	23,687

26.11 Ton 23.69
* Predetermined Tare

	UNIT	TOTALS
Material:		
Freight:		
Tax:		
Fee / Fuel:		
Other Chrg: No		

Today Tons:	545.13	Loads:
Tons To Date:	10,089.99	21
Today Tonnes	494.53	
Tonnes To Date:	9,153.48	

Carrier : 2347032 ROCKY LOGIOVINO TRUCKIN
Vehicle: LR060 Rocky
License: AM637B
MaxGVW: 80,000

By acceptance of this ticket (with or without signature), driver accepts on behalf of themselves/their employer sole responsibility to ensure that the load received is within the weight limit authorized by law and shall hold seller harmless against any and all claims with respect to same CURB DELIVERY ONLY. NOT RESPONSIBLE FOR ANY DAMAGE BEYOND CURB.

Received: _____
Weighmaster: Colleen LeSage

Cust: _____

P/D Status: Deliver

Customer Copy Scale: 1



Plant: 32411

Berlin

368 New Brooklyn Road
Berlin, NJ 08009
856-809-0142

3/24/2017 09:53 In :
Customer: 8638404 THE AMBIENT GROUP LLC
Order : 950949 Camden, NJ. ABC Barrel Project
P.O. :

Tkt. No. 1006027858

Product 114203
Bank Run
S.O. Info: Camden, NJ
Ship Ref: 327 N. Front St



	Pounds	Kilo
Gross	75,600	34,292
Tare	27,220 *	12,347
Net	48,380	21,945

24.19 Ton 21.94
* Predetermined Tare

	UNIT	TOTALS
Material:		
Freight:		
Tax:		
Fee / Fuel:		
Other Chrg: No		

Today Tons:	569.32	Loads:
Tons To Date:	10,114.18	22
Today Tonnes	516.48	
Tonnes To Date:	9,175.43	

Carrier : 9285292 BLUESTONE CONTRACTING C
Vehicle: SB10 AT225C
License: AT225C
MaxGVW: 80,000

By acceptance of this ticket (with or without signature), driver accepts on behalf of themselves/their employer sole responsibility to ensure that the load received is within the weight limit authorized by law and shall hold seller harmless against any and all claims with respect to same CURB DELIVERY ONLY. NOT RESPONSIBLE FOR ANY DAMAGE BEYOND CURB.

Received: _____
Weighmaster: Colleen LeSage

Cust: _____

P/D Status: Deliver

Customer Do Not Accept [2] Scale: 1



Plant: 32411

Berlin

368 New Brooklyn Road
Berlin, NJ 08009
856-809-0142

3/24/2017 10:14

In:

Customer: 8638404 THE AMBIENT GROUP LLC

Order: 950949 Camden, NJ. ABC Barrel Project

P.O.:

Tkt. No. 1006027861

Product 114203

Bank Run

S.O. Info: Camden, NJ.

Ship Ref: 327 N. Front St



	Pounds	Kilo
Gross	79,880	36,233
Tare	25,820 *	11,712
Net	54,060	24,521

27.03 Ton 24.52

* Predetermined Tare

	UNIT	TOTALS
Material:		
Freight:		
Tax:		
Fee / Fuel:		
Other Chrg:	No	

Today Tons:	596.35	Loads:
Tons To Date:	10,141.21	23
Today Tonnes	541.00	
Tonnes To Date:	9,199.95	

Carrier: 8647386 TURKEYROOST TRANSPORT

Vehicle: TUR001 Turkeyroost

License: AP182A

MaxGVW: 80,000

Received:

Cust:

Weighmaster: Colleen LeSage

P/D Status: Deliver

Customer Copy

Scale: 1

By acceptance of this ticket (with or without signature), driver accepts on behalf of themselves/their employer sole responsibility to ensure that the load received is within the weight limit authorized by law and shall hold seller harmless against any and all claims with respect to same CURB DELIVERY ONLY. NOT RESPONSIBLE FOR ANY DAMAGE BEYOND CURB.



Plant: 32411

Berlin

368 New Brooklyn Road
Berlin, NJ 08009
856-809-0142

3/24/2017 10:19

In:

Customer: 8638404 THE AMBIENT GROUP LLC

Order: 950949 Camden, NJ. ABC Barrel Project

P.O.:

Tkt. No. 1006027862

Product 114203

Bank Run

S.O. Info: Camden, NJ.

Ship Ref: 327 N. Front St



	Pounds	Kilo
Gross	77,980	35,371
Tare	24,680 *	11,195
Net	53,300	24,176

26.65 Ton 24.18

* Predetermined Tare

	UNIT	TOTALS
Material:		
Freight:		
Tax:		
Fee / Fuel:		
Other Chrg:	No	

Today Tons:	623.00	Loads:
Tons To Date:	10,167.86	24
Today Tonnes	565.18	
Tonnes To Date:	9,224.13	

Carrier: 8515471 CALLE TRUCKING LLC

Vehicle: CALLE5 Calle Trucking

License: AF49921

MaxGVW: 80,000

Received:

Cust:

Weighmaster: Colleen LeSage

P/D Status: Deliver

Customer Copy

Scale: 1

By acceptance of this ticket (with or without signature), driver accepts on behalf of themselves/their employer sole responsibility to ensure that the load received is within the weight limit authorized by law and shall hold seller harmless against any and all claims with respect to same CURB DELIVERY ONLY. NOT RESPONSIBLE FOR ANY DAMAGE BEYOND CURB.



Plant: 32411

Berlin
368 New Brooklyn Road
Berlin, NJ 08009
856-809-0142

3/24/2017 10:20 In:
Customer: 8638404 THE AMBIENT GROUP LLC
Order: 950949 Camden, NJ. ABC Barrel Project
P.O.:

Tkt. No. 1006027863

Product 114203
Bank Run
S.O. Info: Camden, NJ.
Ship Ref: 327 N. Front St



	Pounds	Kilo
Gross	79,320	35,979
Tare	28,760 *	13,045
Net	50,560	22,934

25.28 Ton 22.93
* Predetermined Tare

	UNIT	TOTALS
Material:		
Freight:		
Tax:		
Fee / Fuel:		
Other Chrg: No		

Today Tons:	648.28	Loads:
Tons To Date:	10,193.14	25
Today Tonnes	588.11	
Tonnes To Date:	9,247.06	

Carrier: 8040648 GJ SCOTT LLC
Vehicle: GS14 GS14
License: As672T
MaxGVW: 80,000

By acceptance of this ticket (with or without signature), driver accepts on behalf of themselves/their employer sole responsibility to ensure that the load received is within the weight limit authorized by law and shall hold seller harmless against any and all claims with respect to same CURB DELIVERY ONLY. NOT RESPONSIBLE FOR ANY DAMAGE BEYOND CURB.

Received: _____
Weighmaster: Colleen LeSage

Cust: _____

P/D Status: Deliver

Customer Do Not Accept [2] Scale: 1



Plant: 32411

Berlin
368 New Brooklyn Road
Berlin, NJ 08009
856-809-0142

3/24/2017 10:26 In:
Customer: 8638404 THE AMBIENT GROUP LLC
Order: 950949 Camden, NJ. ABC Barrel Project
P.O.:

Tkt. No. 1006027866

Product 114203
Bank Run
S.O. Info: Camden, NJ.
Ship Ref: 327 N. Front St



	Pounds	Kilo
Gross	78,460	35,589
Tare	28,060 *	12,728
Net	50,400	22,861

25.20 Ton 22.86
* Predetermined Tare

	UNIT	TOTALS
Material:		
Freight:		
Tax:		
Fee / Fuel:		
Other Chrg: No		

Today Tons:	673.48	Loads:
Tons To Date:	10,218.34	26
Today Tonnes	610.97	
Tonnes To Date:	9,269.92	

Carrier: 8040648 GJ SCOTT LLC
Vehicle: GS16 GS16
License: AT639K
MaxGVW: 80,000

By acceptance of this ticket (with or without signature), driver accepts on behalf of themselves/their employer sole responsibility to ensure that the load received is within the weight limit authorized by law and shall hold seller harmless against any and all claims with respect to same CURB DELIVERY ONLY. NOT RESPONSIBLE FOR ANY DAMAGE BEYOND CURB.

Received: _____
Weighmaster: Colleen LeSage

Cust: _____

P/D Status: Deliver

Customer Do Not Accept [2] Scale: 1



Plant: 32411

Berlin
368 New Brooklyn Road
Berlin, NJ 08009
856-809-0142, -

3/24/2017 10:28 In :
Customer: 8638404 THE AMBIENT GROUP LLC
Order : 950949 Camden, NJ. ABC Barrel Project
P.O. :

Tkt. No. 1006027867

Product 114203
Bank Run
S.O. Info: Camden, NJ.
Ship Ref: 327 N. Front St



	Pounds	Kilo
Gross	78,520	35,616
Tare	28,380 *	12,873
Net	50,140	22,743

25.07 Ton 22.74
* Predetermined Tare

	UNIT	TOTALS
Material:		
Freight:		
Tax:		
Fee / Fuel:		
Other Chrg: No		

Today Tons:	698.55	Loads:
Tons To Date:	10,243.41	27
Today Tonnes	633.71	
Tonnes To Date:	9,292.67	

Carrier : 8040648 GJ SCOTT LLC
Vehicle: GS17 GS17
License: AT640K
MaxGVW: 80,000

By acceptance of this ticket (with or without signature), driver accepts on behalf of themselves/their employer sole responsibility to ensure that the load received is within the weight limit authorized by law and shall hold seller harmless against any and all claims with respect to same CURB DELIVERY ONLY. NOT RESPONSIBLE FOR ANY DAMAGE BEYOND CURB.

Received: _____
Weighmaster: Colleen LeSage

Cust: _____

P/D Status: Deliver

Customer Do Not Accept [2] Scale: 1



Plant: 32411

Berlin
368 New Brooklyn Road
Berlin, NJ 08009
856-809-0142, -

3/24/2017 10:32 In :
Customer: 8638404 THE AMBIENT GROUP LLC
Order : 950949 Camden, NJ. ABC Barrel Project
P.O. :

Tkt. No. 1006027870

Product 114203
Bank Run
S.O. Info: Camden, NJ.
Ship Ref: 327 N. Front St



	Pounds	Kilo
Gross	79,660	36,133
Tare	28,840 *	13,082
Net	50,820	23,052

25.41 Ton 23.05
* Predetermined Tare

	UNIT	TOTALS
Material:		
Freight:		
Tax:		
Fee / Fuel:		
Other Chrg: No		

Today Tons:	723.96	Loads:
Tons To Date:	10,268.82	28
Today Tonnes	656.77	
Tonnes To Date:	9,315.72	

Carrier : 8040648 GJ SCOTT LLC
Vehicle: GS15 GS15
License: AS672T
MaxGVW: 80,000

By acceptance of this ticket (with or without signature), driver accepts on behalf of themselves/their employer sole responsibility to ensure that the load received is within the weight limit authorized by law and shall hold seller harmless against any and all claims with respect to same CURB DELIVERY ONLY. NOT RESPONSIBLE FOR ANY DAMAGE BEYOND CURB.

Received: _____
Weighmaster: Colleen LeSage

Cust: _____

P/D Status: Deliver

Customer Do Not Accept [1] Scale: 1



Plant: 32411

Berlin

368 New Brooklyn Road
Berlin, NJ 08009
856-809-0142

3/24/2017 10:38 In:
Customer: 8638404 THE AMBIENT GROUP LLC
Order : 950949 Camden, NJ. ABC Barrel Project
P.O. :

Tkt. No. 1006027872

Product 114203
Bank Run
S.O. Info: Camden, NJ.
Ship Ref: 327 N. Front St



	Pounds	Kilo
Gross	76,680	34,781
Tare	23,400 *	10,614
Net	53,280	24,167

26.64 Ton 24.17

* Predetermined Tare

	UNIT	TOTALS
Material:		
Freight:		
Tax:		
Fee / Fuel:		
Other Chrg:	No	

Today Tons:	750.60	Loads:
Tons To Date:	10,295.46	29
Today Tonnes	680.93	
Tonnes To Date:	9,339.88	

Carrier : 8515471 CALLE TRUCKING LLC
Vehicle: CALLE9 Grey truck
License: AG07469
MaxGVW: 80,000

By acceptance of this ticket (with or without signature), driver accepts on behalf of themselves/their employer sole responsibility to ensure that the load received is within the weight limit authorized by law and shall hold seller harmless against any and all claims with respect to same CURB DELIVERY ONLY. NOT RESPONSIBLE FOR ANY DAMAGE BEYOND CURB.

Received: [Signature]
Weighmaster: Colleen LeSage

Cust: _____

P/D Status: Deliver

Customer Copy

Scale: 1



Plant: 32411

Berlin

368 New Brooklyn Road
Berlin, NJ 08009
856-809-0142

3/24/2017 10:40 In:
Customer: 8638404 THE AMBIENT GROUP LLC
Order : 950949 Camden, NJ. ABC Barrel Project
P.O. :

Tkt. No. 1006027873

Product 114203
Bank Run
S.O. Info: Camden, NJ.
Ship Ref: 327 N. Front St



	Pounds	Kilo
Gross	79,180	35,915
Tare	27,720 *	12,574
Net	51,460	23,342

25.73 Ton 23.34

* Predetermined Tare

	UNIT	TOTALS
Material:		
Freight:		
Tax:		
Fee / Fuel:		
Other Chrg:	No	

Today Tons:	776.33	Loads:
Tons To Date:	10,321.19	30
Today Tonnes	704.27	
Tonnes To Date:	9,363.23	

Carrier : 3804135 MOD HAULING SERVICES
Vehicle: MOD105 MOD Hauling Services
License: AT496J
MaxGVW: 80,000

By acceptance of this ticket (with or without signature), driver accepts on behalf of themselves/their employer sole responsibility to ensure that the load received is within the weight limit authorized by law and shall hold seller harmless against any and all claims with respect to same CURB DELIVERY ONLY. NOT RESPONSIBLE FOR ANY DAMAGE BEYOND CURB.

Received: [Signature]
Weighmaster: Colleen LeSage

Cust: _____

P/D Status: Deliver

Customer Do Not Accept [2]

Scale: 1



Plant: 32411

Berlin

368 New Brooklyn Road
Berlin, NJ 08009
856-809-0142

3/24/2017 10:43

In :

Customer: 8638404 THE AMBIENT GROUP LLC

Order : 950949 Camden, NJ. ABC Barrel Project

P.O. :

Tkt. No. 1006027874

Product 114203

Bank Run

S.O. Info: Camden, NJ.

Ship Ref: 327 N. Front St



	Pounds	Kilo
Gross	78,500	35,607
Tare	24,600 *	11,158
Net	53,900	24,449

26.95 Ton 24.45

* Predetermined Tare

	UNIT	TOTALS
Material:		
Freight:		
Tax:		
Fee / Fuel:		
Other Chrg: No		

Today Tons:	803.28	Loads:
Tons To Date:	10,348.14	31
Today Tonnes	728.72	
Tonnes To Date:	9,387.67	

Carrier : 2346970 GEORGE LAZOS TRUCKING

Vehicle: LG004 AP213T

License: LG004

MaxGVW: 80,000

Received: _____

Cust: _____

Weighmaster: Colleen LeSage

P/D Status: Deliver

Customer Copy

Scale: 1

By acceptance of this ticket (with or without signature), driver accepts on behalf of themselves/their employer sole responsibility to ensure that the load received is within the weight limit authorized by law and shall hold seller harmless against any and all claims with respect to same CURB DELIVERY ONLY. NOT RESPONSIBLE FOR ANY DAMAGE BEYOND CURB.



Plant: 32411

Berlin

368 New Brooklyn Road
Berlin, NJ 08009
856-809-0142

3/24/2017 10:48

In :

Customer: 8638404 THE AMBIENT GROUP LLC

Order : 950949 Camden, NJ. ABC Barrel Project

P.O. :

Tkt. No. 1006027875

Product 114203

Bank Run

S.O. Info: Camden, NJ.

Ship Ref: 327 N. Front St



	Pounds	Kilo
Gross	79,200	35,925
Tare	24,740 *	11,222
Net	54,460	24,703

27.23 Ton 24.70

* Predetermined Tare

	UNIT	TOTALS
Material:		
Freight:		
Tax:		
Fee / Fuel:		
Other Chrg: No		

Today Tons:	830.51	Loads:
Tons To Date:	10,375.37	32
Today Tonnes	753.43	
Tonnes To Date:	9,412.38	

Carrier : 8540415 S CUMMINS LLC

Vehicle: CUM17 Steve

License: AT979F

MaxGVW: 80,000

Received: _____

Cust: _____

Weighmaster: Colleen LeSage

P/D Status: Deliver

Customer Copy

Scale: 1

By acceptance of this ticket (with or without signature), driver accepts on behalf of themselves/their employer sole responsibility to ensure that the load received is within the weight limit authorized by law and shall hold seller harmless against any and all claims with respect to same CURB DELIVERY ONLY. NOT RESPONSIBLE FOR ANY DAMAGE BEYOND CURB.



Plant: 32411

Berlin

368 New Brooklyn Road
Berlin, NJ 08009
856-809-0142

3/24/2017 10:59

In :

Customer: 8638404 THE AMBIENT GROUP LLC

Order : 950949 Camden, NJ. ABC Barrel Project

P.O. :

Tkt. No. 1006027880



Product 114203

Bank Run

S.O. Info: Camden, NJ.

Ship Ref: 327 N. Front St

	Pounds	Kilo
Gross	79,880	36,233
Tare	26,640 *	12,084
Net	53,240	24,149

26.62 Ton 24.15

* Predetermined Tare

	UNIT	TOTALS
Material:		
Freight:		
Tax:		
Fee / Fuel:		
Other Chrg:	No	

Today Tons:	857.13	Loads:
Tons To Date:	10,401.99	33
Today Tonnes	777.58	
Tonnes To Date:	9,436.53	

By acceptance of this ticket (with or without signature), driver accepts on behalf of themselves/their employer sole responsibility to ensure that the load received is within the weight limit authorized by law and shall hold seller harmless against any and all claims with respect to same
CURB DELIVERY ONLY. NOT RESPONSIBLE FOR ANY DAMAGE BEYOND CURB.

Carrier : 2347032 ROCKY LOGIOVINO TRUCKIN

Vehicle: LR060 Rocky

License: AM637B

MaxGVW: 80,000

Received: _____

Cust: _____

Weighmaster: Colleen LeSage

P/D Status: Deliver

Customer Copy

Scale: 1



Plant: 32411

Berlin

368 New Brooklyn Road
Berlin, NJ 08009
856-809-0142

3/24/2017 11:26

In :

Customer: 8638404 THE AMBIENT GROUP LLC

Order : 950949 Camden, NJ. ABC Barrel Project

P.O. :

Tkt. No. 1006027882



Product 114203

Bank Run

S.O. Info: Camden, NJ.

Ship Ref: 327 N. Front St

	Pounds	Kilo
Gross	77,740	35,262
Tare	27,220 *	12,347
Net	50,520	22,915

25.26 Ton 22.92

* Predetermined Tare

	UNIT	TOTALS
Material:		
Freight:		
Tax:		
Fee / Fuel:		
Other Chrg:	No	

Today Tons:	882.39	Loads:
Tons To Date:	10,427.25	34
Today Tonnes	800.49	
Tonnes To Date:	9,459.44	

By acceptance of this ticket (with or without signature), driver accepts on behalf of themselves/their employer sole responsibility to ensure that the load received is within the weight limit authorized by law and shall hold seller harmless against any and all claims with respect to same
CURB DELIVERY ONLY. NOT RESPONSIBLE FOR ANY DAMAGE BEYOND CURB.

Carrier : 9285292 BLUESTONE CONTRACTING C

Vehicle: SB10 AT225C

License: AT225C

MaxGVW: 80,000

Received: _____

Cust: _____

Weighmaster: Colleen LeSage

P/D Status: Deliver

Customer Do Not Accept [2]

Scale: 1



Plant: 32411

Berlin

368 New Brooklyn Road
Berlin, NJ 08009
856-809-0142

3/24/2017 11:54

In :

Customer: 8638404 THE AMBIENT GROUP LLC

Order : 950949 Camden, NJ. ABC Barrel Project

P.O. :

Tkt. No. 1006027886

Product 114203



Bank Run

S.O. Info: Camden, NJ.

Ship Ref: 327 N. Front St

	Pounds	Kilo
Gross	79,940	36,260
Tare	25,820 *	11,712
Net	54,120	24,548

27.06 Ton 24.55

* Predetermined Tare

Material:	UNIT	TOTALS
Freight:		
Tax:		
Fee / Fuel:		
Other Chrg: No		

Today Tons:	909.45	Loads:
Tons To Date:	10,454.31	35
Today Tonnes	825.04	
Tonnes To Date:	9,483.99	

Carrier : 8647386 TURKEYROOST TRANSPORT

Vehicle: TUR001 Turkeyroost

License: AP182A

MaxGVW: 80,000

Received:

Cust:

Weighmaster: Colleen LeSage

P/D Status: Deliver

Customer Do Not Accept [1] Scale: 1

By acceptance of this ticket (with or without signature), driver accepts on behalf of themselves/their employer sole responsibility to ensure that the load received is within the weight limit authorized by law and shall hold seller harmless against any and all claims with respect to same CURB DELIVERY ONLY. NOT RESPONSIBLE FOR ANY DAMAGE BEYOND CURB.



Plant: 32411

Berlin

368 New Brooklyn Road
Berlin, NJ 08009
856-809-0142

3/24/2017 11:55

In :

Customer: 8638404 THE AMBIENT GROUP LLC

Order : 950949 Camden, NJ. ABC Barrel Project

P.O. :

Tkt. No. 1006027887

Product 114203



Bank Run

S.O. Info: Camden, NJ.

Ship Ref: 327 N. Front St

	Pounds	Kilo
Gross	77,840	35,308
Tare	24,680 *	11,195
Net	53,160	24,113

26.58 Ton 24.11

* Predetermined Tare

Material:	UNIT	TOTALS
Freight:		
Tax:		
Fee / Fuel:		
Other Chrg: No		

Today Tons:	936.03	Loads:
Tons To Date:	10,480.89	36
Today Tonnes	849.15	
Tonnes To Date:	9,508.10	

Carrier : 8515471 CALLE TRUCKING LLC

Vehicle: CALLE5 Calle Trucking

License: AF49921

MaxGVW: 80,000

Received:

Cust:

Weighmaster: Colleen LeSage

P/D Status: Deliver

Customer Copy Scale: 1

By acceptance of this ticket (with or without signature), driver accepts on behalf of themselves/their employer sole responsibility to ensure that the load received is within the weight limit authorized by law and shall hold seller harmless against any and all claims with respect to same CURB DELIVERY ONLY. NOT RESPONSIBLE FOR ANY DAMAGE BEYOND CURB.



Plant: 32411

Berlin
368 New Brooklyn Road
Berlin, NJ 08009
856-809-0142, -

3/24/2017 11:58 In:
Customer: 8638404 THE AMBIENT GROUP LLC
Order: 950949 Camden, NJ. ABC Barrel Project
P.O.:

Tkt. No. 1006027888

Product 114203
Bank Run
S.O. Info: Camden, NJ.
Ship Ref: 327 N. Front St



	Pounds	Kilo
Gross	77,940	35,353
Tare	28,060 *	12,728
Net	49,880	22,625

24.94 Ton 22.63

* Predetermined Tare

UNIT	TOTALS
Material:	
Freight:	
Tax:	
Fee / Fuel:	
Other Chrg: No	

Today Tons:	960.97	Loads:
Tons To Date:	10,505.83	37
Today Tonnes	871.78	
Tonnes To Date:	9,530.73	

Carrier: 8040648 GJ SCOTT LLC

Vehicle: GS16 GS16

License: AT639K

MaxGVW: 80,000

By acceptance of this ticket (with or without signature), driver accepts on behalf of themselves/their employer sole responsibility to ensure that the load received is within the weight limit authorized by law and shall hold seller harmless against any and all claims with respect to same CURB DELIVERY ONLY. NOT RESPONSIBLE FOR ANY DAMAGE BEYOND CURB.

Received: _____

Cust: _____

Weighmaster: Colleen LeSage

P/D Status: Deliver

Customer Do Not Accept [2] Scale: 1



Plant: 32411

Berlin
368 New Brooklyn Road
Berlin, NJ 08009
856-809-0142,

3/24/2017 12:11 In:
Customer: 8638404 THE AMBIENT GROUP LLC
Order: 950949 Camden, NJ. ABC Barrel Project
P.O.:

Tkt. No. 1006027893

Product 114203
Bank Run
S.O. Info: Camden, NJ.
Ship Ref: 327 N. Front St



	Pounds	Kilo
Gross	78,960	35,816
Tare	27,720 *	12,574
Net	51,240	23,242

25.62 Ton 23.24

* Predetermined Tare

UNIT	TOTALS
Material:	
Freight:	
Tax:	
Fee / Fuel:	
Other Chrg: No	

Today Tons:	986.59	Loads:
Tons To Date:	10,531.45	38
Today Tonnes	895.02	
Tonnes To Date:	9,553.97	

Carrier: 3804135 MOD HAULING SERVICES

Vehicle: MOD105 MOD Hauling Services

License: AT496J

MaxGVW: 80,000

Received:

Cust: _____

Weighmaster: Colleen LeSage

P/D Status: Deliver

Customer Do Not Accept [2] Scale: 1

By acceptance of this ticket (with or without signature), driver accepts on behalf of themselves/their employer sole responsibility to ensure that the load received is within the weight limit authorized by law and shall hold seller harmless against any and all claims with respect to same CURB DELIVERY ONLY. NOT RESPONSIBLE FOR ANY DAMAGE BEYOND CURB.



Plant: 32411

Berlin
368 New Brooklyn Road
Berlin, NJ 08009
856-809-0142

3/24/2017 12:14 In :
Customer: 8638404 THE AMBIENT GROUP LLC
Order : 950949 Camden, NJ. ABC Barrel Project
P.O. :

Tkt. No. 1006027894

Product 114203
Bank Run
S.O. Info: Camden, NJ.
Ship Ref: 327 N. Front St



	UNIT	TOTALS
Material:		
Freight:		
Tax:		
Fee / Fuel:		
Other Chrg: No		

	Pounds	Kilo
Gross	78,380	35,553
Tare	24,600 *	11,158
Net	53,780	24,394

26.89 Ton 24.39

* Predetermined Tare

Today Tons:	1,013.48	Loads:
Tons To Date:	10,558.34	39
Today Tonnes	919.41	
Tonnes To Date:	9,578.36	

By acceptance of this ticket (with or without signature), driver accepts on behalf of themselves/their employer sole responsibility to ensure that the load received is within the weight limit authorized by law and shall holdseller harmless against any and all claims with respect to same
CURB DELIVERY ONLY. NOT RESPONSIBLE FOR ANY DAMAGE BEYOND CURB.

Carrier : 2346970 GEORGE LAZOS TRUCKING
Vehicle: LG004 AP213T
License: LG004
MaxGVW: 80,000
Received: _____
Weighmaster: Colleen LeSage

Cust: _____

P/D Status: Deliver

Customer Copy Scale: 1



Plant: 32411

Berlin
368 New Brooklyn Road
Berlin, NJ 08009
856-809-0142

3/24/2017 12:19 In :
Customer: 8638404 THE AMBIENT GROUP LLC
Order : 950949 Camden, NJ. ABC Barrel Project
P.O. :

Tkt. No. 1006027896

Product 114203
Bank Run
S.O. Info: Camden, NJ.
Ship Ref: 327 N. Front St



	UNIT	TOTALS
Material:		
Freight:		
Tax:		
Fee / Fuel:		
Other Chrg: No		

	Pounds	Kilo
Gross	77,560	35,181
Tare	23,400 *	10,614
Net	54,160	24,567

27.08 Ton 24.57

* Predetermined Tare

Today Tons:	1,040.56	Loads:
Tons To Date:	10,585.42	40
Today Tonnes	943.98	
Tonnes To Date:	9,602.93	

By acceptance of this ticket (with or without signature), driver accepts on behalf of themselves/their employer sole responsibility to ensure that the load received is within the weight limit authorized by law and shall holdseller harmless against any and all claims with respect to same
CURB DELIVERY ONLY. NOT RESPONSIBLE FOR ANY DAMAGE BEYOND CURB.

Carrier : 8515471 CALLE TRUCKING LLC
Vehicle: CALLE9 Grey truck
License: AG07469
MaxGVW: 80,000
Received: _____
Weighmaster: Colleen LeSage

Cust: _____

P/D Status: Deliver

Customer Copy Scale: 1



Plant: 32411

Berlin

368 New Brooklyn Road
Berlin, NJ 08009
856-809-0142

3/24/2017 12:26 In :
Customer: 8638404 THE AMBIENT GROUP LLC
Order : 950949 Camden, NJ. ABC Barrel Project
P.O. :

Tkt. No. 1006027898

Product 114203
Bank Run
S.O. Info: Camden, NJ.
Ship Ref: 327 N. Front St



	Pounds	Kilo
Gross	79,740	36,169
Tare	24,740 *	11,222
Net	55,000	24,948

27.50 Ton 24.95
* Predetermined Tare

	UNIT	TOTALS
Material:		
Freight:		
Tax:		
Fee / Fuel:		
Other Chrg: No		

Today Tons:	1,068.06	Loads:
Tons To Date:	10,612.92	41
Today Tonnes	968.93	
Tonnes To Date:	9,627.88	

Carrier : 8540415 S CUMMINS LLC

Vehicle: CUM17 Steve

License: AT979F

MaxGVW: 80,000

Received: Steve Cummins Cust: _____

Weighmaster: Colleen LeSage

P/D Status: Deliver

Customer Copy

Scale: 1

By acceptance of this ticket (with or without signature), driver accepts on behalf of themselves/their employer sole responsibility to ensure that the load received is within the weight limit authorized by law and shall hold seller harmless against any and all claims with respect to same CURB DELIVERY ONLY. NOT RESPONSIBLE FOR ANY DAMAGE BEYOND CURB.



Plant: 32411

Berlin

368 New Brooklyn Road
Berlin, NJ 08009
856-809-0142

3/24/2017 12:38 In :
Customer: 8638404 THE AMBIENT GROUP LLC
Order : 950949 Camden, NJ. ABC Barrel Project
P.O. :

Tkt. No. 1006027900

Product 114203
Bank Run
S.O. Info: Camden, NJ.
Ship Ref: 327 N. Front St



	Pounds	Kilo
Gross	77,260	35,045
Tare	26,640 *	12,084
Net	50,620	22,961

25.31 Ton 22.96
* Predetermined Tare

	UNIT	TOTALS
Material:		
Freight:		
Tax:		
Fee / Fuel:		
Other Chrg: No		

Today Tons:	1,093.37	Loads:
Tons To Date:	10,638.23	42
Today Tonnes	991.89	
Tonnes To Date:	9,650.84	

Carrier : 2347032 ROCKY LOGIOVINO TRUCKIN

Vehicle: LR060 Rocky

License: AM637B

MaxGVW: 80,000

Received: _____ Cust: _____

Weighmaster: Colleen LeSage

P/D Status: Deliver

Customer Do Not Accept [1]

Scale: 1

By acceptance of this ticket (with or without signature), driver accepts on behalf of themselves/their employer sole responsibility to ensure that the load received is within the weight limit authorized by law and shall hold seller harmless against any and all claims with respect to same CURB DELIVERY ONLY. NOT RESPONSIBLE FOR ANY DAMAGE BEYOND CURB.



Plant: 32411

Berlin
368 New Brooklyn Road
Berlin, NJ 08009
856-809-0142, -

3/24/2017 13:20 In :
Customer: 8638404 THE AMBIENT GROUP LLC
Order: 950949 Camden, NJ. ABC Barrel Project
P.O. :

Tkt. No. 1006027906



Product 114203
Bank Run
S.O. Info: Camden, NJ.
Ship Ref: 327 N. Front St

	Pounds	Kilo
Gross	76,380	34,645
Tare	27,220 *	12,347
Net	49,160	22,299

24.58 Ton 22.30
* Predetermined Tare

	UNIT	TOTALS
Material:		
Freight:		
Tax:		
Fee / Fuel:		
Other Chrg:	No	

Today Tons:	1,117.95	Loads:
Tons To Date:	10,662.81	43
Today Tonnes	1,014.19	
Tonnes To Date:	9,673.14	

Carrier : 9285292 BLUESTONE CONTRACTING C
Vehicle: SB10 AT225C
License: AT225C
MaxGVW: 80,000

By acceptance of this ticket (with or without signature), driver accepts on behalf of themselves/their employer sole responsibility to ensure that the load received is within the weight limit authorized by law and shall hold seller harmless against any and all claims with respect to same CURB DELIVERY ONLY. NOT RESPONSIBLE FOR ANY DAMAGE BEYOND CURB.

Received:
Weighmaster: Colleen LeSage
P/D Status: Deliver

Cust: _____

Customer Do Not Accept [2] Scale: 1



Plant: 32411

Berlin
368 New Brooklyn Road
Berlin, NJ 08009
856-809-0142, -

3/24/2017 13:30 In :
Customer: 8638404 THE AMBIENT GROUP LLC
Order: 950949 Camden, NJ. ABC Barrel Project
P.O. :

Tkt. No. 1006027907



Product 114203
Bank Run
S.O. Info: Camden, NJ.
Ship Ref: 327 N. Front St

	Pounds	Kilo
Gross	78,120	35,435
Tare	28,060 *	12,728
Net	50,060	22,707

25.03 Ton 22.71
* Predetermined Tare

	UNIT	TOTALS
Material:		
Freight:		
Tax:		
Fee / Fuel:		
Other Chrg:	No	

Today Tons:	1,142.98	Loads:
Tons To Date:	10,687.84	44
Today Tonnes	1,036.89	
Tonnes To Date:	9,695.85	

Carrier : 8040648 GJ SCOTT LLC
Vehicle: GS16 GS16
License: AT639K
MaxGVW: 80,000

By acceptance of this ticket (with or without signature), driver accepts on behalf of themselves/their employer sole responsibility to ensure that the load received is within the weight limit authorized by law and shall hold seller harmless against any and all claims with respect to same CURB DELIVERY ONLY. NOT RESPONSIBLE FOR ANY DAMAGE BEYOND CURB.

Received:
Weighmaster: Colleen LeSage
P/D Status: Deliver

Cust: _____

Customer Do Not Accept [2] Scale: 1



Plant: 32411

Berlin
368 New Brooklyn Road
Berlin, NJ 08009
856-809-0142

3/24/2017 13:33 In: 12:46:51
Customer: 8638404 THE AMBIENT GROUP LLC
Order: 950949 Camden, NJ. ABC Barrel Project
P.O.:

Tkt. No. 1006027908



Product 114203
Bank Run
S.O. Info: Camden, NJ.
Ship Ref: 327 N. Front St

	Pounds	Kilo
Gross	79,540	36,079
Tare	28,840 *	13,082
Net	50,700	22,997
	25.35 Ton	23.00

* Predetermined Tare

Today Tons:	1,168.33	Loads:
Tons To Date:	10,713.19	45
Today Tonnes	1,059.89	
Tonnes To Date:	9,718.84	

By acceptance of this ticket (with or without signature), driver accepts on behalf of themselves/their employer sole responsibility to ensure that the load received is within the weight limit authorized by law and shall hold seller harmless against any and all claims with respect to same
CURB DELIVERY ONLY. NOT RESPONSIBLE FOR ANY DAMAGE BEYOND CURB.

	UNIT	TOTALS
Material:		
Freight:		
Tax:		
Fee / Fuel:		
Other Chrg: No		

Carrier: 8040648 GJ SCOTT LLC
Vehicle: GS15 GS15
License: AS672T
MaxGVW: 80,000

Received: _____ Cust: _____
Weighmaster: Colleen LeSage

P/D Status: Deliver

Customer Do Not Accept [3] Scale: 1



Plant: 32411

Berlin
368 New Brooklyn Road
Berlin, NJ 08009
856-809-0142

3/24/2017 13:38 In: 12:46:27
Customer: 8638404 THE AMBIENT GROUP LLC
Order: 950949 Camden, NJ. ABC Barrel Project
P.O.:

Tkt. No. 1006027910



Product 114203
Bank Run
S.O. Info: Camden, NJ.
Ship Ref: 327 N. Front St

	Pounds	Kilo
Gross	79,980	36,278
Tare	28,760 *	13,045
Net	51,220	23,233
	25.61 Ton	23.23

* Predetermined Tare

Today Tons:	1,193.94	Loads:
Tons To Date:	10,738.80	46
Today Tonnes	1,083.12	
Tonnes To Date:	9,742.08	

By acceptance of this ticket (with or without signature), driver accepts on behalf of themselves/their employer sole responsibility to ensure that the load received is within the weight limit authorized by law and shall hold seller harmless against any and all claims with respect to same
CURB DELIVERY ONLY. NOT RESPONSIBLE FOR ANY DAMAGE BEYOND CURB.

	UNIT	TOTALS
Material:		
Freight:		
Tax:		
Fee / Fuel:		
Other Chrg: No		

Carrier: 8040648 GJ SCOTT LLC
Vehicle: GS14 GS14
License: AS672T
MaxGVW: 80,000

Received: _____ Cust: _____
Weighmaster: Colleen LeSage

P/D Status: Deliver

Customer Do Not Accept [1] Scale: 1



Plant: 32411

Berlin
368 New Brooklyn Road
Berlin, NJ 08009
856-809-0142

3/24/2017 13:41 In: 12:47:03
Customer: 8638404 THE AMBIENT GROUP LLC
Order: 950949 Camden, NJ. ABC Barrel Project
P.O.:

Tkt. No. 1006027911



Product 114203
Bank Run
S.O. Info: Camden, NJ
Ship Ref: 327 N. Front St

	Pounds	Kilo
Gross	79,200	35,925
Tare	28,380 *	12,873
Net	50,820	23,052
	25.41 Ton	23.05

* Predetermined Tare

Today Tons:	1,219.35	Loads:
Tons To Date:	10,764.21	47
Today Tonnes	1,106.18	
Tonnes To Date:	9,765.13	

By acceptance of this ticket (with or without signature), driver accepts on behalf of themselves/their employer sole responsibility to ensure that the load received is within the weight limit authorized by law and shall hold seller harmless against any and all claims with respect to same CURB DELIVERY ONLY. NOT RESPONSIBLE FOR ANY DAMAGE BEYOND CURB.

	UNIT	TOTALS
Material:		
Freight:		
Tax:		
Fee / Fuel:		
Other Chrg: No		

Carrier: 8040648 GJ SCOTT LLC
Vehicle: GS17 GS17
License: AT640K
MaxGVW: 80,000

Received: _____
Weighmaster: Colleen LeSage

Cust: _____

P/D Status: Deliver

Customer Do Not Accept [3] Scale: 1



Plant: 32411

Berlin
368 New Brooklyn Road
Berlin, NJ 08009
856-809-0142

3/24/2017 13:50 In:
Customer: 8638404 THE AMBIENT GROUP LLC
Order: 950949 Camden, NJ. ABC Barrel Project
P.O.:

Tkt. No. 1006027913



Product 114203
Bank Run
S.O. Info: Camden, NJ
Ship Ref: 327 N. Front St

	Pounds	Kilo
Gross	76,460	34,682
Tare	23,400 *	10,614
Net	53,060	24,068
	26.53 Ton	24.07

* Predetermined Tare

Today Tons:	1,245.88	Loads:
Tons To Date:	10,790.74	48
Today Tonnes	1,130.24	
Tonnes To Date:	9,789.19	

By acceptance of this ticket (with or without signature), driver accepts on behalf of themselves/their employer sole responsibility to ensure that the load received is within the weight limit authorized by law and shall hold seller harmless against any and all claims with respect to same CURB DELIVERY ONLY. NOT RESPONSIBLE FOR ANY DAMAGE BEYOND CURB.

	UNIT	TOTALS
Material:		
Freight:		
Tax:		
Fee / Fuel:		
Other Chrg: No		

Carrier: 8515471 CALLE TRUCKING LLC
Vehicle: CALLE9 Grey truck
License: AG07469
MaxGVW: 80,000

Received: _____
Weighmaster: Colleen LeSage

Cust: _____

P/D Status: Deliver

Customer Do Not Accept [2] Scale: 1



Plant: 32411

Berlin

368 New Brooklyn Road
Berlin, NJ 08009
856-809-0142

3/24/2017 13:51

In:

Customer: 8638404 THE AMBIENT GROUP LLC

Order : 950949 Camden, NJ. ABC Barrel Project

P.O.:

Tkt. No. 1006027914



Product 114203

Bank Run

S.O. Info: Camden, NJ.

Ship Ref: 327 N. Front St

	Pounds	Kilo
Gross	78,160	35,453
Tare	24,600 *	11,158
Net	53,560	24,294

26.78 Ton 24.29

* Predetermined Tare

	UNIT	TOTALS
Material:		
Freight:		
Tax:		
Fee / Fuel:		
Other Chrg:	No	

Today Tons:	1,272.66	Loads:
Tons To Date:	10,817.52	49
Today Tonnes	1,154.54	
Tonnes To Date:	9,813.49	

Carrier : 2346970 GEORGE LAZOS TRUCKING

Vehicle: LG004 AP213T

License: LG004

MaxGVW: 80,000

Received:

Weighmaster: Colleen LeSage

Cust:

P/D Status: Deliver

By acceptance of this ticket (with or without signature), driver accepts on behalf of themselves/their employer sole responsibility to ensure that the load received is within the weight limit authorized by law and shall hold seller harmless against any and all claims with respect to same
CURB DELIVERY ONLY .NOT RESPONSIBLE FOR ANY DAMAGE BEYOND CURB.

Customer Copy

Scale: 1



Plant: 32411

Berlin

368 New Brooklyn Road
Berlin, NJ 08009
856-809-0142

3/27/2017 07:14 In: 6:33:25
Customer: 8638404 THE AMBIENT GROUP LLC
Order: 950949 Camden, NJ. ABC Barrel Project
P.O.:

Tkt. No. 1006027922

Product 114203
Bank Run
S.O. Info: Camden, NJ.
Ship Ref: 327 N. Front St



	Pounds	Kilo
Gross	78,920	35,798
Tare	24,560	11,140
Net	54,360	24,657

27.18 Ton 24.66

	UNIT	TOTALS
Material:		
Freight:		
Tax:		
Fee / Fuel:		
Other Chrg: No		

Today Tons:	27.18	Loads:
Tons To Date:	10,844.70	1
Today Tonnes	24.66	
Tonnes To Date:	9,838.15	

By acceptance of this ticket (with or without signature), driver accepts on behalf of themselves/their employer sole responsibility to ensure that the load received is within the weight limit authorized by law and shall hold seller harmless against any and all claims with respect to same CURB DELIVERY ONLY. NOT RESPONSIBLE FOR ANY DAMAGE BEYOND CURB.

Carrier: 2346970 GEORGE LAZOS TRUCKING
Vehicle: LG004 AP213T
License: LG004
MaxGVW: 80,000

Received: _____
Weighmaster: Colleen LeSage

Cust: _____

P/D Status: Deliver

Customer Copy

Scale: 1



Plant: 32411

Berlin

368 New Brooklyn Road
Berlin, NJ 08009
856-809-0142

3/27/2017 07:18 In: 6:34:10
Customer: 8638404 THE AMBIENT GROUP LLC
Order: 950949 Camden, NJ. ABC Barrel Project
P.O.:

Tkt. No. 1006027923

Product 114203
Bank Run
S.O. Info: Camden, NJ.
Ship Ref: 327 N. Front St



	Pounds	Kilo
Gross	79,020	35,843
Tare	28,520	12,936
Net	50,500	22,906

25.25 Ton 22.91

	UNIT	TOTALS
Material:		
Freight:		
Tax:		
Fee / Fuel:		
Other Chrg: No		

Today Tons:	52.43	Loads:
Tons To Date:	10,869.95	2
Today Tonnes	47.56	
Tonnes To Date:	9,861.05	

By acceptance of this ticket (with or without signature), driver accepts on behalf of themselves/their employer sole responsibility to ensure that the load received is within the weight limit authorized by law and shall hold seller harmless against any and all claims with respect to same CURB DELIVERY ONLY. NOT RESPONSIBLE FOR ANY DAMAGE BEYOND CURB.

Carrier: 8040648 GJ SCOTT LLC
Vehicle: GS11 GS11
License: AN120Z
MaxGVW: 80,000

Received: _____
Weighmaster: Colleen LeSage

Cust: _____

P/D Status: Deliver

Customer Copy

Scale: 1



Plant: 32411

Berlin

368 New Brooklyn Road
Berlin, NJ 08009
856-809-0142

3/27/2017 07:20

In: 6:35:15

Customer: 8638404 THE AMBIENT GROUP LLC

Order : 950949 Camden, NJ. ABC Barrel Project

P.O. :

Tkt. No. 1006027924

Product 114203

Bank Run

S.O. Info: Camden, NJ.

Ship Ref: 327 N. Front St



	Pounds	Kilo
Gross	79,300	35,970
Tare	28,340	12,855
Net	50,960	23,115

25.48 Ton 23.12

	UNIT	TOTALS
Material:		
Freight:		
Tax:		
Fee / Fuel:		
Other Chrg: No		

Today Tons:	77.91	Loads:
Tons To Date:	10,895.43	3
Today Tonnes	70.68	
Tonnes To Date:	9,884.17	

By acceptance of this ticket (with or without signature), driver accepts on behalf of themselves/their employer sole responsibility to ensure that the load received is within the weight limit authorized by law and shall hold seller harmless against any and all claims with respect to same CURB DELIVERY ONLY. NOT RESPONSIBLE FOR ANY DAMAGE BEYOND CURB.

Carrier : 8040648 GJ SCOTT LLC

Vehicle: GS17 GS17

License: AT640K

MaxGVW: 80,000

Received: _____

Cust: _____

Weighmaster: Colleen LeSage

P/D Status: Deliver

Customer Copy

Scale: 1



Plant: 32411

Berlin

368 New Brooklyn Road
Berlin, NJ 08009
856-809-0142

3/27/2017 07:27

In: 6:35:41

Customer: 8638404 THE AMBIENT GROUP LLC

Order : 950949 Camden, NJ. ABC Barrel Project

P.O. :

Tkt. No. 1006027925

Product 114203

Bank Run

S.O. Info: Camden, NJ.

Ship Ref: 327 N. Front St



	Pounds	Kilo
Gross	79,000	35,834
Tare	27,100	12,292
Net	51,900	23,541

25.95 Ton 23.54

	UNIT	TOTALS
Material:		
Freight:		
Tax:		
Fee / Fuel:		
Other Chrg: No		

Today Tons:	103.86	Loads:
Tons To Date:	10,921.38	4
Today Tonnes	94.22	
Tonnes To Date:	9,907.71	

By acceptance of this ticket (with or without signature), driver accepts on behalf of themselves/their employer sole responsibility to ensure that the load received is within the weight limit authorized by law and shall hold seller harmless against any and all claims with respect to same CURB DELIVERY ONLY. NOT RESPONSIBLE FOR ANY DAMAGE BEYOND CURB.

Carrier : 8040648 GJ SCOTT LLC

Vehicle: GS6 GS6

License: AK761C

MaxGVW: 80,000

Received: _____

Cust: _____

Weighmaster: Colleen LeSage

P/D Status: Deliver

Customer Copy

Scale: 1



Plant: 32411

Berlin

368 New Brooklyn Road
Berlin, NJ 08009
856-809-0142

3/27/2017 07:29 In: 6:36:15
Customer: 8638404 THE AMBIENT GROUP LLC
Order: 950949 Camden, NJ. ABC Barrel Project
P.O.:

Tkt. No. 1006027926

Product 114203
Bank Run
S.O. Info: Camden, NJ.
Ship Ref: 327 N. Front St



	Pounds	Kilo
Gross	78,400	35,562
Tare	28,080	12,737
Net	50,320	22,825

25.16 Ton 22.82

	UNIT	TOTALS
Material:		
Freight:		
Tax:		
Fee / Fuel:		
Other Chrg: No		

Today Tons:	129.02	Loads:
Tons To Date:	10,946.54	5
Today Tonnes	117.04	
Tonnes To Date:	9,930.53	

Carrier: 8040648 GJ SCOTT LLC
Vehicle: GS16 GS16
License: AT639K
MaxGVW: 80,000

By acceptance of this ticket (with or without signature), driver accepts on behalf of themselves/their employer sole responsibility to ensure that the load received is within the weight limit authorized by law and shall hold seller harmless against any and all claims with respect to same CURB DELIVERY ONLY. NOT RESPONSIBLE FOR ANY DAMAGE BEYOND CURB.

Received:
Weighmaster: Colleen LeSage

Cust: _____

P/D Status: Deliver

Customer Copy

Scale: 1



Plant: 32411

Berlin

368 New Brooklyn Road
Berlin, NJ 08009
856-809-0142

3/27/2017 07:33 In: 6:41:52
Customer: 8638404 THE AMBIENT GROUP LLC
Order: 950949 Camden, NJ. ABC Barrel Project
P.O.:

Tkt. No. 1006027927

Product 114203
Bank Run
S.O. Info: Camden, NJ.
Ship Ref: 327 N. Front St



	Pounds	Kilo
Gross	78,460	35,589
Tare	24,640	11,177
Net	53,820	24,412

26.91 Ton 24.41

	UNIT	TOTALS
Material:		
Freight:		
Tax:		
Fee / Fuel:		
Other Chrg: No		

Today Tons:	155.93	Loads:
Tons To Date:	10,973.45	6
Today Tonnes	141.46	
Tonnes To Date:	9,954.95	

Carrier: 8540415 S CUMMINS LLC
Vehicle: CUM17 Steve
License: AT979F
MaxGVW: 80,000

By acceptance of this ticket (with or without signature), driver accepts on behalf of themselves/their employer sole responsibility to ensure that the load received is within the weight limit authorized by law and shall hold seller harmless against any and all claims with respect to same CURB DELIVERY ONLY. NOT RESPONSIBLE FOR ANY DAMAGE BEYOND CURB.

Received:
Weighmaster: Colleen LeSage

Cust: _____

P/D Status: Deliver

Customer Copy

Scale: 1



Plant: 32411

Berlin

368 New Brooklyn Road
Berlin, NJ 08009
856-809-0142

3/27/2017 07:37

In: 6:50:59

Customer: 8638404 THE AMBIENT GROUP LLC

Order: 950949 Camden, NJ. ABC Barrel Project

P.O.:

Tkt. No. 1006027928

Product 114203

Bank Run

S.O. Info: Camden, NJ.

Ship Ref: 327 N. Front St



	Pounds	Kilo
Gross	77,000	34,927
Tare	27,260	12,365
Net	49,740	22,562

24.87 Ton 22.56

UNIT	TOTALS
Material:	
Freight:	
Tax:	
Fee / Fuel:	
Other Chrg: No	

Today Tons:	180.80	Loads:
Tons To Date:	10,998.32	7
Today Tonnes	164.02	
Tonnes To Date:	9,977.51	

Carrier: 9285292 BLUESTONE CONTRACTING C

Vehicle: SB10 AT225C

License: AT225C

MaxGVW: 80,000

Received: *[Signature]* Cust: _____

Weighmaster: Colleen LeSage

P/D Status: Deliver

Customer Copy

Scale: 1

By acceptance of this ticket (with or without signature), driver accepts on behalf of themselves/their employer sole responsibility to ensure that the load received is within the weight limit authorized by law and shall hold seller harmless against any and all claims with respect to same CURB DELIVERY ONLY. NOT RESPONSIBLE FOR ANY DAMAGE BEYOND CURB.



Plant: 32411

Berlin

368 New Brooklyn Road
Berlin, NJ 08009
856-809-0142

3/27/2017 07:40

In: 6:56:26

Customer: 8638404 THE AMBIENT GROUP LLC

Order: 950949 Camden, NJ. ABC Barrel Project

P.O.:

Tkt. No. 1006027929

Product 114203

Bank Run

S.O. Info: Camden, NJ.

Ship Ref: 327 N. Front St



	Pounds	Kilo
Gross	78,380	35,553
Tare	27,580	12,510
Net	50,800	23,042

25.40 Ton 23.04

UNIT	TOTALS
Material:	
Freight:	
Tax:	
Fee / Fuel:	
Other Chrg: No	

Today Tons:	206.20	Loads:
Tons To Date:	11,023.72	8
Today Tonnes	187.06	
Tonnes To Date:	10,000.55	

Carrier: 3804135 MOD HAULING SERVICES

Vehicle: MOD105 MOD Hauling Services

License: AT496J

MaxGVW: 80,000

Received: *[Signature]* Cust: _____

Weighmaster: Colleen LeSage

P/D Status: Deliver

Customer Copy

Scale: 1

By acceptance of this ticket (with or without signature), driver accepts on behalf of themselves/their employer sole responsibility to ensure that the load received is within the weight limit authorized by law and shall hold seller harmless against any and all claims with respect to same CURB DELIVERY ONLY. NOT RESPONSIBLE FOR ANY DAMAGE BEYOND CURB.



Plant: 32411

Berlin

368 New Brooklyn Road
Berlin, NJ 08009
856-809-0142

3/27/2017 08:24 In: 8:06:13
Customer: 8638404 THE AMBIENT GROUP LLC
Order: 950949 Camden, NJ. ABC Barrel Project
P.O.:

Tkt. No. 1006027934

Product 114203
Bank Run
S.O. Info: Camden, NJ.
Ship Ref: 327 N. Front St



	Pounds	Kilo
Gross	79,360	35,997
Tare	26,320	11,939
Net	53,040	24,059

26.52 Ton 24.06

UNIT	TOTALS
Material:	
Freight:	
Tax:	
Fee / Fuel:	
Other Chrg: No	

Today Tons:	232.72	Loads:
Tons To Date:	11,050.24	9
Today Tonnes	211.12	
Tonnes To Date:	10,024.61	

Carrier: 2347243 A P SIMIONE
Vehicle: SA194 Simione
License: AB423G
MaxGVW: 80,000
Received: _____
Weighmaster: Colleen LeSage

By acceptance of this ticket (with or without signature), driver accepts on behalf of themselves/their employer sole responsibility to ensure that the load received is within the weight limit authorized by law and shall hold seller harmless against any and all claims with respect to same CURB DELIVERY ONLY. NOT RESPONSIBLE FOR ANY DAMAGE BEYOND CURB.

Cust: _____

P/D Status: Deliver

Customer Copy

Scale: 1



Plant: 32411

Berlin

368 New Brooklyn Road
Berlin, NJ 08009
856-809-0142

3/27/2017 09:08 In:
Customer: 8638404 THE AMBIENT GROUP LLC
Order: 950949 Camden, NJ. ABC Barrel Project
P.O.:

Tkt. No. 1006027940

Product 114203
Bank Run
S.O. Info: Camden, NJ.
Ship Ref: 327 N. Front St



	Pounds	Kilo
Gross	76,640	34,763
Tare	28,340 *	12,855
Net	48,300	21,909

24.15 Ton 21.91

* Predetermined Tare

UNIT	TOTALS
Material:	
Freight:	
Tax:	
Fee / Fuel:	
Other Chrg: No	

Today Tons:	256.87	Loads:
Tons To Date:	11,074.39	10
Today Tonnes	233.03	
Tonnes To Date:	10,046.52	

Carrier: 8040648 GJ SCOTT LLC
Vehicle: GS17 GS17
License: AT640K
MaxGVW: 80,000

By acceptance of this ticket (with or without signature), driver accepts on behalf of themselves/their employer sole responsibility to ensure that the load received is within the weight limit authorized by law and shall hold seller harmless against any and all claims with respect to same CURB DELIVERY ONLY. NOT RESPONSIBLE FOR ANY DAMAGE BEYOND CURB.

Received: _____
Weighmaster: Colleen LeSage

Cust: _____

P/D Status: Deliver

Customer Copy

Scale: 1



Plant: 32411

Berlin

368 New Brooklyn Road
Berlin, NJ 08009
856-809-0142

3/27/2017 09:14

In :

Customer: 8638404 THE AMBIENT GROUP LLC

Order : 950949 Camden, NJ. ABC Barrel Project

P.O. :

Tkt. No. 1006027942



Product 114203

Bank Run

S.O. Info: Camden, NJ.

Ship Ref: 327 N. Front St

	Pounds	Kilo
Gross	79,200	35,925
Tare	28,520 *	12,936
Net	50,680	22,988

25.34 Ton 22.99

* Predetermined Tare

	UNIT	TOTALS
Material:		
Freight:		
Tax:		
Fee / Fuel:		
Other Chrg: No		

Today Tons:	282.21	Loads:
Tons To Date:	11,099.73	11
Today Tonnes	256.02	
Tonnes To Date:	10,069.51	

Carrier : 8040648 GJ SCOTT LLC

Vehicle: GS11 GS11

License: AN120Z

MaxGVW: 80,000

Received: _____

Cust: _____

Weighmaster: Colleen LeSage

P/D Status: Deliver

Customer Copy

Scale: 1

By acceptance of this ticket (with or without signature), driver accepts on behalf of themselves/their employer sole responsibility to ensure that the load received is within the weight limit authorized by law and shall hold seller harmless against any and all claims with respect to same CURB DELIVERY ONLY. NOT RESPONSIBLE FOR ANY DAMAGE BEYOND CURB.



Plant: 32411

Berlin

368 New Brooklyn Road
Berlin, NJ 08009
856-809-0142

3/27/2017 09:22

In :

Customer: 8638404 THE AMBIENT GROUP LLC

Order : 950949 Camden, NJ. ABC Barrel Project

P.O. :

Tkt. No. 1006027944



Product 114203

Bank Run

S.O. Info: Camden, NJ.

Ship Ref: 327 N. Front St

	Pounds	Kilo
Gross	78,060	35,407
Tare	24,560 *	11,140
Net	53,500	24,267

26.75 Ton 24.27

* Predetermined Tare

	UNIT	TOTALS
Material:		
Freight:		
Tax:		
Fee / Fuel:		
Other Chrg: No		

Today Tons:	308.96	Loads:
Tons To Date:	11,126.48	12
Today Tonnes	280.28	
Tonnes To Date:	10,093.77	

Carrier : 2346970 GEORGE LAZOS TRUCKING

Vehicle: LG004 AP213T

License: LG004

MaxGVW: 80,000

Received: _____

Cust: _____

Weighmaster: Colleen LeSage

P/D Status: Deliver

Customer Copy

Scale: 1

By acceptance of this ticket (with or without signature), driver accepts on behalf of themselves/their employer sole responsibility to ensure that the load received is within the weight limit authorized by law and shall hold seller harmless against any and all claims with respect to same CURB DELIVERY ONLY. NOT RESPONSIBLE FOR ANY DAMAGE BEYOND CURB.



Plant: 32411

Berlin

368 New Brooklyn Road
Berlin, NJ 08009
856-809-0142

3/27/2017 09:25 In :
Customer: 8638404 THE AMBIENT GROUP LLC
Order : 950949 Camden, NJ. ABC Barrel Project
P.O. :

Tkt. No. 1006027945

Product 114203
Bank Run
S.O. Info: Camden, NJ.
Ship Ref: 327 N. Front St



	Pounds	Kilo
Gross	77,600	35,199
Tare	24,640 *	11,177
Net	52,960	24,022

26.48 Ton 24.02
* Predetermined Tare

	UNIT	TOTALS
Material:		
Freight:		
Tax:		
Fee / Fuel:		
Other Chrg: No		

Today Tons:	335.44	Loads:
Tons To Date:	11,152.96	13
Today Tonnes	304.31	
Tonnes To Date:	10,117.80	

Carrier : 8540415 S CUMMINS LLC

Vehicle: CUM17 Steve

License: AT979F

MaxGVW: 80,000

Received: Cust: _____

Weighmaster: Colleen LeSage

P/D Status: Deliver

Customer Copy

Scale: 1

By acceptance of this ticket (with or without signature), driver accepts on behalf of themselves/their employer sole responsibility to ensure that the load received is within the weight limit authorized by law and shall hold seller harmless against any and all claims with respect to same CURB DELIVERY ONLY. NOT RESPONSIBLE FOR ANY DAMAGE BEYOND CURB.



Plant: 32411

Berlin

368 New Brooklyn Road
Berlin, NJ 08009
856-809-0142

3/27/2017 09:27 In :
Customer: 8638404 THE AMBIENT GROUP LLC
Order : 950949 Camden, NJ. ABC Barrel Project
P.O. :

Tkt. No. 1006027946

Product 114203
Bank Run
S.O. Info: Camden, NJ.
Ship Ref: 327 N. Front St



	Pounds	Kilo
Gross	79,360	35,997
Tare	27,100 *	12,292
Net	52,260	23,705

26.13 Ton 23.70
* Predetermined Tare

	UNIT	TOTALS
Material:		
Freight:		
Tax:		
Fee / Fuel:		
Other Chrg: No		

Today Tons:	361.57	Loads:
Tons To Date:	11,179.09	14
Today Tonnes	328.01	
Tonnes To Date:	10,141.50	

Carrier : 8040648 GJ SCOTT LLC

Vehicle: GS6 GS6

License: AK761C

MaxGVW: 80,000

Received: Cust: _____

Weighmaster: Colleen LeSage

P/D Status: Deliver

Customer Copy

Scale: 1

By acceptance of this ticket (with or without signature), driver accepts on behalf of themselves/their employer sole responsibility to ensure that the load received is within the weight limit authorized by law and shall hold seller harmless against any and all claims with respect to same CURB DELIVERY ONLY. NOT RESPONSIBLE FOR ANY DAMAGE BEYOND CURB.



Plant: 32411

Berlin
368 New Brooklyn Road
Berlin, NJ 08009
856-809-0142

3/27/2017 09:29 In :
Customer: 8638404 THE AMBIENT GROUP LLC
Order : 950949 Camden, NJ. ABC Barrel Project
P.O. :

Tkt. No. 1006027947

Product 114203
Bank Run
S.O. Info: Camden, NJ.
Ship Ref: 327 N. Front St



	Pounds	Kilo
Gross	79,960	36,269
Tare	28,080 *	12,737
Net	51,880	23,532

25.94 Ton 23.53
* Predetermined Tare

	UNIT	TOTALS
Material:		
Freight:		
Tax:		
Fee / Fuel:		
Other Chrg: No		

Today Tons:	387.51	Loads:	
Tons To Date:	11,205.03		15
Today Tonnes	351.54		
Tonnes To Date:	10,165.03		

Carrier : 8040648 GJ SCOTT LLC
Vehicle: GS16 GS16
License: AT639K
MaxGVW: 80,000

By acceptance of this ticket (with or without signature), driver accepts on behalf of themselves/their employer sole responsibility to ensure that the load received is within the weight limit authorized by law and shall holdseller harmless against any and all claims with respect to same CURB DELIVERY ONLY. NOT RESPONSIBLE FOR ANY DAMAGE BEYOND CURB.

Received:
Weighmaster: Colleen LeSage

Cust: _____

P/D Status: Deliver

Customer Copy Scale: 1



Plant: 32411

Berlin
368 New Brooklyn Road
Berlin, NJ 08009
856-809-0142

3/27/2017 09:40 In :
Customer: 8638404 THE AMBIENT GROUP LLC
Order : 950949 Camden, NJ. ABC Barrel Project
P.O. :

Tkt. No. 1006027949

Product 114203
Bank Run
S.O. Info: Camden, NJ.
Ship Ref: 327 N. Front St



	Pounds	Kilo
Gross	79,260	35,952
Tare	27,580 *	12,510
Net	51,680	23,442

25.84 Ton 23.44
* Predetermined Tare

	UNIT	TOTALS
Material:		
Freight:		
Tax:		
Fee / Fuel:		
Other Chrg: No		

Today Tons:	413.35	Loads:	
Tons To Date:	11,230.87		16
Today Tonnes	374.98		
Tonnes To Date:	10,188.47		

Carrier : 3804135 MOD HAULING SERVICES
Vehicle: MOD105 MOD Hauling Services
License: AT496J
MaxGVW: 80,000

By acceptance of this ticket (with or without signature), driver accepts on behalf of themselves/their employer sole responsibility to ensure that the load received is within the weight limit authorized by law and shall holdseller harmless against any and all claims with respect to same CURB DELIVERY ONLY. NOT RESPONSIBLE FOR ANY DAMAGE BEYOND CURB.

Received:
Weighmaster: Colleen LeSage

Cust: _____

P/D Status: Deliver

Customer Copy Scale: 1



Plant: 32411

Berlin

368 New Brooklyn Road
Berlin, NJ 08009
856-809-0142

3/27/2017 10:03 In :
Customer: 8638404 THE AMBIENT GROUP LLC
Order : 950949 Camden, NJ. ABC Barrel Project
P.O. :

Tkt. No. 1006027953

Product 114203
Bank Run
S.O. Info: Camden, NJ.
Ship Ref: 327 N. Front St



	Pounds	Kilo
Gross	77,860	35,317
Tare	26,320 *	11,939
Net	51,540	23,378

25.77 Ton 23.38

* Predetermined Tare

	UNIT	TOTALS
Material:		
Freight:		
Tax:		
Fee / Fuel:		
Other Chrg: No		

Today Tons:	439.12	Loads:
Tons To Date:	11,256.64	17
Today Tonnes	398.36	
Tonnes To Date:	10,211.85	

Carrier : 2347243 A P SIMIONE
Vehicle: SA194 Simione
License: AB423G
MaxGVW: 80,000

By acceptance of this ticket (with or without signature), driver accepts on behalf of themselves/their employer sole responsibility to ensure that the load received is within the weight limit authorized by law and shall holdseller harmless against any and all claims with respect to same CURB DELIVERY ONLY. NOT RESPONSIBLE FOR ANY DAMAGE BEYOND CURB.

Received: _____
Weighmaster: Colleen LeSage

Cust: _____

P/D Status: Deliver

Customer Copy

Scale: 1



Plant: 32411

Berlin

368 New Brooklyn Road
Berlin, NJ 08009
856-809-0142

3/27/2017 10:29 In :
Customer: 8638404 THE AMBIENT GROUP LLC
Order : 950949 Camden, NJ. ABC Barrel Project
P.O. :

Tkt. No. 1006027954

Product 114203
Bank Run
S.O. Info: Camden, NJ.
Ship Ref: 327 N. Front St

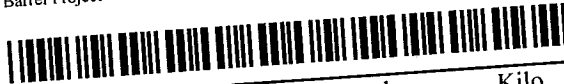

	Pounds	Kilo
Gross	79,100	35,879
Tare	28,340 *	12,855
Net	50,760	23,024

25.38 Ton 23.02

* Predetermined Tare

	UNIT	TOTALS
Material:		
Freight:		
Tax:		
Fee / Fuel:		
Other Chrg: No		

Today Tons:	464.50	Loads:
Tons To Date:	11,282.02	18
Today Tonnes	421.39	
Tonnes To Date:	10,234.88	

By acceptance of this ticket (with or without signature), driver accepts on behalf of themselves/their employer sole responsibility to ensure that the load received is within the weight limit authorized by law and shall holdseller harmless against any and all claims with respect to same CURB DELIVERY ONLY. NOT RESPONSIBLE FOR ANY DAMAGE BEYOND CURB.

Carrier : 8040648 GJ SCOTT LLC
Vehicle: GS17 GS17
License: AT640K
MaxGVW: 80,000

Cust: _____

Received: _____
Weighmaster: Colleen LeSage

P/D Status: Deliver

Customer Copy

Scale: 1



Plant: 32411

Berlin

368 New Brooklyn Road
Berlin, NJ 08009
856-809-0142

3/27/2017 10:34 In :
Customer: 8638404 THE AMBIENT GROUP LLC
Order : 950949 Camden, NJ. ABC Barrel Project
P.O. :

Tkt. No. 1006027955

Product 114203
Bank Run
S.O. Info: Camden, NJ.
Ship Ref: 327 N. Front St



	Pounds	Kilo
Gross	78,500	35,607
Tare	28,520 *	12,936
Net	49,980	22,671

24.99 Ton 22.67
* Predetermined Tare

	UNIT	TOTALS
Material:		
Freight:		
Tax:		
Fee / Fuel:		
Other Chrg: No		

Today Tons:	489.49	Loads:
Tons To Date:	11,307.01	19
Today Tonnes	444.06	
Tonnes To Date:	10,257.55	

Carrier : 8040648 GJ SCOTT LLC
Vehicle: GS11 GS11
License: AN120Z
MaxGVW: 80,000

By acceptance of this ticket (with or without signature), driver accepts on behalf of themselves/their employer sole responsibility to ensure that the load received is within the weight limit authorized by law and shall holdseller harmless against any and all claims with respect to same CURB DELIVERY ONLY. NOT RESPONSIBLE FOR ANY DAMAGE BEYOND CURB.

Received: _____
Weighmaster: Colleen LeSage

Cust: _____

P/D Status: Deliver

Customer Copy

Scale: 1



Plant: 32411

Berlin

368 New Brooklyn Road
Berlin, NJ 08009
856-809-0142

3/27/2017 10:52 In :
Customer: 8638404 THE AMBIENT GROUP LLC
Order : 950949 Camden, NJ. ABC Barrel Project
P.O. :

Tkt. No. 1006027958

Product 114203
Bank Run
S.O. Info: Camden, NJ.
Ship Ref: 327 N. Front St



	Pounds	Kilo
Gross	79,340	35,988
Tare	24,560 *	11,140
Net	54,780	24,848

27.39 Ton 24.85
* Predetermined Tare

	UNIT	TOTALS
Material:		
Freight:		
Tax:		
Fee / Fuel:		
Other Chrg: No		

Today Tons:	516.88	Loads:
Tons To Date:	11,334.40	20
Today Tonnes	468.91	
Tonnes To Date:	10,282.39	

Carrier : 2346970 GEORGE LAZOS TRUCKING
Vehicle: LG004 AP213T
License: LG004
MaxGVW: 80,000

By acceptance of this ticket (with or without signature), driver accepts on behalf of themselves/their employer sole responsibility to ensure that the load received is within the weight limit authorized by law and shall holdseller harmless against any and all claims with respect to same CURB DELIVERY ONLY. NOT RESPONSIBLE FOR ANY DAMAGE BEYOND CURB.

Received: _____
Weighmaster: Colleen LeSage

Cust: _____

P/D Status: Deliver

Customer Copy

Scale: 1



Plant: 32411

Berlin

368 New Brooklyn Road
Berlin, NJ 08009
856-809-0142

3/27/2017 10:55 In:
Customer: 8638404 THE AMBIENT GROUP LLC
Order : 950949 Camden, NJ. ABC Barrel Project
P.O. :

Tkt. No. 1006027959



Product 114203
Bank Run
S.O. Info: Camden, NJ.
Ship Ref: 327 N. Front St

	Pounds	Kilo
Gross	75,960	34,455
Tare	24,640 *	11,177
Net	51,320	23,278

25.66 Ton 23.28

* Predetermined Tare

	UNIT	TOTALS
Material:		
Freight:		
Tax:		
Fee / Fuel:		
Other Chrg: No		

Today Tons:	542.54	Loads:
Tons To Date:	11,360.06	21
Today Tonnes	492.18	
Tonnes To Date:	10,305.67	

By acceptance of this ticket (with or without signature), driver accepts on behalf of themselves/their employer sole responsibility to ensure that the load received is within the weight limit authorized by law and shall hold seller harmless against any and all claims with respect to same CURB DELIVERY ONLY. NOT RESPONSIBLE FOR ANY DAMAGE BEYOND CURB.

Carrier : 8540415 S CUMMINS LLC

Vehicle: CUM17 Steve

License: AT979F

MaxGVW: 80,000

Received:  Cust: _____

Weighmaster: Colleen LeSage

P/D Status: Deliver

Customer Copy

Scale: 1



Plant: 32411

Berlin

368 New Brooklyn Road
Berlin, NJ 08009
856-809-0142

3/27/2017 11:03 In:
Customer: 8638404 THE AMBIENT GROUP LLC
Order : 950949 Camden, NJ. ABC Barrel Project
P.O. :

Tkt. No. 1006027960



Product 114203
Bank Run
S.O. Info: Camden, NJ.
Ship Ref: 327 N. Front St

	Pounds	Kilo
Gross	79,140	35,897
Tare	28,080 *	12,737
Net	51,060	23,160

25.53 Ton 23.16

* Predetermined Tare

	UNIT	TOTALS
Material:		
Freight:		
Tax:		
Fee / Fuel:		
Other Chrg: No		

Today Tons:	568.07	Loads:
Tons To Date:	11,385.59	22
Today Tonnes	515.34	
Tonnes To Date:	10,328.83	

By acceptance of this ticket (with or without signature), driver accepts on behalf of themselves/their employer sole responsibility to ensure that the load received is within the weight limit authorized by law and shall hold seller harmless against any and all claims with respect to same CURB DELIVERY ONLY. NOT RESPONSIBLE FOR ANY DAMAGE BEYOND CURB.

Carrier : 8040648 GJ SCOTT LLC

Vehicle: GS16 GS16

License: AT639K

MaxGVW: 80,000

Received:  Cust: _____

Weighmaster: Colleen LeSage

P/D Status: Deliver

Customer Copy

Scale: 1



Plant: 32411

Berlin

368 New Brooklyn Road
Berlin, NJ 08009
856-809-0142

3/27/2017 11:05 In :
Customer: 8638404 THE AMBIENT GROUP LLC
Order : 950949 Camden, NJ. ABC Barrel Project
P.O. :

Tkt. No. 1006027961



Product 114203
Bank Run
S.O. Info: Camden, NJ.
Ship Ref: 327 N. Front St

	Pounds	Kilo
Gross	78,780	35,734
Tare	27,100 *	12,292
Net	51,680	23,442

25.84 Ton 23.44

* Predetermined Tare

	UNIT	TOTALS
Material:		
Freight:		
Tax:		
Fee / Fuel:		
Other Chrg: No		

Today Tons:	593.91	Loads:
Tons To Date:	11,411.43	23
Today Tonnes	538.79	
Tonnes To Date:	10,352.28	

By acceptance of this ticket (with or without signature), driver accepts on behalf of themselves/their employer sole responsibility to ensure that the load received is within the weight limit authorized by law and shall hold seller harmless against any and all claims with respect to same CURB DELIVERY ONLY. NOT RESPONSIBLE FOR ANY DAMAGE BEYOND CURB.

Carrier : 8040648 GJ SCOTT LLC

Vehicle: GS6 GS6

License: AK761C

MaxGVW: 80,000

Received:

Cust: _____

Weighmaster: Colleen LeSage

P/D Status: Deliver

Customer Copy

Scale: 1



Plant: 32411

Berlin

368 New Brooklyn Road
Berlin, NJ 08009
856-809-0142

3/27/2017 11:11 In : 10:47:12
Customer: 8638404 THE AMBIENT GROUP LLC
Order : 950949 Camden, NJ. ABC Barrel Project
P.O. :

Tkt. No. 1006027963



Product 114203
Bank Run
S.O. Info: Camden, NJ.
Ship Ref: 327 N. Front St

	Pounds	Kilo
Gross	77,660	35,226
Tare	26,980	12,238
Net	50,680	22,988

25.34 Ton 22.99

	UNIT	TOTALS
Material:		
Freight:		
Tax:		
Fee / Fuel:		
Other Chrg: No		

Today Tons:	619.25	Loads:
Tons To Date:	11,436.77	24
Today Tonnes	561.77	
Tonnes To Date:	10,375.26	

By acceptance of this ticket (with or without signature), driver accepts on behalf of themselves/their employer sole responsibility to ensure that the load received is within the weight limit authorized by law and shall hold seller harmless against any and all claims with respect to same CURB DELIVERY ONLY. NOT RESPONSIBLE FOR ANY DAMAGE BEYOND CURB.

Carrier : 2347631 R A DIMARIA

Vehicle: DY026 DiMaria

License: AS200U

MaxGVW: 80,000

Received:

Cust: _____

Weighmaster: Colleen LeSage

P/D Status: Deliver

Customer Do Not Accept [1]

Scale: 1



Plant: 32411

Berlin

368 New Brooklyn Road
Berlin, NJ 08009
856-809-0142

3/27/2017 11:16 In :
Customer: 8638404 THE AMBIENT GROUP LLC
Order : 950949 Camden, NJ. ABC Barrel Project
P.O. :

Tkt. No. 1006027965

Product 114203
Bank Run
S.O. Info: Camden, NJ.
Ship Ref: 327 N. Front St



	Pounds	Kilo
Gross	77,940	35,353
Tare	27,580 *	12,510
Net	50,360	22,843

25.18 Ton 22.84
* Predetermined Tare

	UNIT	TOTALS
Material:		
Freight:		
Tax:		
Fee / Fuel:		
Other Chrg: No		

Today Tons:	644.43	Loads:
Tons To Date:	11,461.95	25
Today Tonnes	584.62	
Tonnes To Date:	10,398.11	

Carrier : 3804135 MOD HAULING SERVICES
Vehicle: MOD105 MOD Hauling Services
License: AT496J
MaxGVW: 80,000

By acceptance of this ticket (with or without signature), driver accepts on behalf of themselves/their employer sole responsibility to ensure that the load received is within the weight limit authorized by law and shall hold seller harmless against any and all claims with respect to same CURB DELIVERY ONLY. NOT RESPONSIBLE FOR ANY DAMAGE BEYOND CURB.

Received: [Signature]
Weighmaster: Colleen LeSage

Cust: _____

P/D Status: Deliver

Customer Copy

Scale: 1



Plant: 32411

Berlin

368 New Brooklyn Road
Berlin, NJ 08009
856-809-0142

3/27/2017 11:48 In :
Customer: 8638404 THE AMBIENT GROUP LLC
Order : 950949 Camden, NJ. ABC Barrel Project
P.O. :

Tkt. No. 1006027968

Product 114203
Bank Run
S.O. Info: Camden, NJ.
Ship Ref: 327 N. Front St



	Pounds	Kilo
Gross	76,980	34,918
Tare	28,340 *	12,855
Net	48,640	22,063

24.32 Ton 22.06
* Predetermined Tare

	UNIT	TOTALS
Material:		
Freight:		
Tax:		
Fee / Fuel:		
Other Chrg: No		

Today Tons:	668.75	Loads:
Tons To Date:	11,486.27	26
Today Tonnes	606.68	
Tonnes To Date:	10,420.17	

Carrier : 8040648 GJ SCOTT LLC
Vehicle: GS17 GS17
License: AT640K
MaxGVW: 80,000

By acceptance of this ticket (with or without signature), driver accepts on behalf of themselves/their employer sole responsibility to ensure that the load received is within the weight limit authorized by law and shall hold seller harmless against any and all claims with respect to same CURB DELIVERY ONLY. NOT RESPONSIBLE FOR ANY DAMAGE BEYOND CURB.

Received: _____
Weighmaster: Colleen LeSage

Cust: _____

P/D Status: Deliver

Customer Copy

Scale: 1



Plant: 32411

Berlin

368 New Brooklyn Road
Berlin, NJ 08009
856-809-0142

3/27/2017 11:54

In :

Customer: 8638404 THE AMBIENT GROUP LLC
Order : 950949 Camden, NJ. ABC Barrel Project
P.O. :

Tkt. No. 1006027969

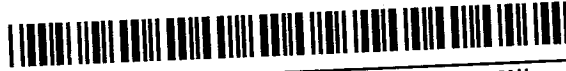

Product 114203
Bank Run
S.O. Info: Camden, NJ.
Ship Ref: 327 N. Front St

	Pounds	Kilo
Gross	79,340	35,988
Tare	28,520 *	12,936
Net	50,820	23,052

25.41 Ton 23.05

* Predetermined Tare

	UNIT	TOTALS
Material:		
Freight:		
Tax:		
Fee / Fuel:		
Other Chrg: No		

Today Tons:	694.16	Loads:
Tons To Date:	11,511.68	27
Today Tonnes	629.73	
Tonnes To Date:	10,443.22	

Carrier : 8040648 GJ SCOTT LLC
Vehicle: GS11 GS11
License: AN120Z
MaxGVW: 80,000
Received: _____
Weighmaster: Colleen LeSage

P/D Status: Deliver

Cust: _____

By acceptance of this ticket (with or without signature), driver accepts on behalf of themselves/their employer sole responsibility to ensure that the load received is within the weight limit authorized by law and shall holdseller harmless against any and all claims with respect to same CURB DELIVERY ONLY. NOT RESPONSIBLE FOR ANY DAMAGE BEYOND CURB.

Customer Copy Scale: 1



Plant: 32411

Berlin

368 New Brooklyn Road
Berlin, NJ 08009
856-809-0142

3/27/2017 12:19

In :

Customer: 8638404 THE AMBIENT GROUP LLC
Order : 950949 Camden, NJ. ABC Barrel Project
P.O. :

Tkt. No. 1006027973



Product 114203
Bank Run
S.O. Info: Camden, NJ.
Ship Ref: 327 N. Front St

	Pounds	Kilo
Gross	74,740	33,901
Tare	24,560 *	11,140
Net	50,180	22,761

25.09 Ton 22.76

* Predetermined Tare

	UNIT	TOTALS
Material:		
Freight:		
Tax:		
Fee / Fuel:		
Other Chrg: No		

Today Tons:	719.25	Loads:
Tons To Date:	11,536.77	28
Today Tonnes	652.49	
Tonnes To Date:	10,465.98	

Carrier : 2346970 GEORGE LAZOS TRUCKING
Vehicle: LG004 AP213T
License: LG004
MaxGVW: 80,000
Received: _____
Weighmaster: Colleen LeSage

P/D Status: Deliver

Cust: _____

By acceptance of this ticket (with or without signature), driver accepts on behalf of themselves/their employer sole responsibility to ensure that the load received is within the weight limit authorized by law and shall holdseller harmless against any and all claims with respect to same CURB DELIVERY ONLY. NOT RESPONSIBLE FOR ANY DAMAGE BEYOND CURB.

Customer Copy Scale: 1



Plant: 32411

Berlin
368 New Brooklyn Road
Berlin, NJ 08009
856-809-0142

3/27/2017 12:27 In :
Customer: 8638404 THE AMBIENT GROUP LLC
Order : 950949 Camden, NJ. ABC Barrel Project
P.O. :

Tkt. No. 1006027975

Product 114203
Bank Run
S.O. Info: Camden, NJ.
Ship Ref: 327 N. Front St



	Pounds	Kilo
Gross	77,800	35,289
Tare	28,080 *	12,737
Net	49,720	22,553

24.86 Ton 22.55

* Predetermined Tare

	UNIT	TOTALS
Material:		
Freight:		
Tax:		
Fee / Fuel:		
Other Chrg: No		

Today Tons:	744.11	Loads:
Tons To Date:	11,561.63	29
Today Tonnes	675.05	
Tonnes To Date:	10,488.53	

Carrier : 8040648 GJ SCOTT LLC

Vehicle: GS16 GS16

License: AT639K

MaxGVW: 80,000

Received:

Weighmaster: Colleen LeSage

By acceptance of this ticket (with or without signature), driver accepts on behalf of themselves/their employer sole responsibility to ensure that the load received is within the weight limit authorized by law and shall hold seller harmless against any and all claims with respect to same CURB DELIVERY ONLY. NOT RESPONSIBLE FOR ANY DAMAGE BEYOND CURB.

Cust: _____

P/D Status: Deliver

Customer Copy Scale: 1



Plant: 32411

Berlin
368 New Brooklyn Road
Berlin, NJ 08009
856-809-0142

3/27/2017 12:35 In :
Customer: 8638404 THE AMBIENT GROUP LLC
Order : 950949 Camden, NJ. ABC Barrel Project
P.O. :

Tkt. No. 1006027979

Product 114203
Bank Run
S.O. Info: Camden, NJ.
Ship Ref: 327 N. Front St



	Pounds	Kilo
Gross	73,520	33,348
Tare	27,100 *	12,292
Net	46,420	21,056

23.21 Ton 21.06

* Predetermined Tare

	UNIT	TOTALS
Material:		
Freight:		
Tax:		
Fee / Fuel:		
Other Chrg: No		

Today Tons:	767.32	Loads:
Tons To Date:	11,584.84	30
Today Tonnes	696.10	
Tonnes To Date:	10,509.59	

Carrier : 8040648 GJ SCOTT LLC

Vehicle: GS6 GS6

License: AK761C

MaxGVW: 80,000

Received:

Weighmaster: Colleen LeSage

By acceptance of this ticket (with or without signature), driver accepts on behalf of themselves/their employer sole responsibility to ensure that the load received is within the weight limit authorized by law and shall hold seller harmless against any and all claims with respect to same CURB DELIVERY ONLY. NOT RESPONSIBLE FOR ANY DAMAGE BEYOND CURB.

Cust: _____

P/D Status: Deliver

Customer Do Not Accept [1] Scale: 1



Plant: 32411

Berlin

368 New Brooklyn Road
Berlin, NJ 08009
856-809-0142

3/27/2017 12:40 In: 12:13:06
Customer: 8638404 THE AMBIENT GROUP LLC
Order : 950949 Camden, NJ. ABC Barrel Project
P.O. :

Tkt. No. 1006027982

Product 114203
Bank Run
S.O. Info: Camden, NJ.
Ship Ref: 327 N. Front St



	Pounds	Kilo
Gross	76,980	34,918
Tare	26,380	11,966
Net	50,600	22,952
	25.30 Ton	22.95

	UNIT	TOTALS
Material:		
Freight:		
Tax:		
Fee / Fuel:		
Other Chrg: No		

Today Tons:	792.62	Loads:
Tons To Date:	11,610.14	31
Today Tonnes	719.05	
Tonnes To Date:	10,532.54	

By acceptance of this ticket (with or without signature), driver accepts on behalf of themselves/their employer sole responsibility to ensure that the load received is within the weight limit authorized by law and shall hold seller harmless against any and all claims with respect to same CURB DELIVERY ONLY. NOT RESPONSIBLE FOR ANY DAMAGE BEYOND CURB.

Carrier : 2347032 ROCKY LOGIOVINO TRUCKIN
Vehicle: LR060 Rocky
License: AM637B
MaxGVW: 80,000

Received: _____ Cust: _____

Weighmaster: Colleen LeSage

P/D Status: Deliver

Customer Copy

Scale: 1



Plant: 32411

Berlin

368 New Brooklyn Road
Berlin, NJ 08009
856-809-0142

3/27/2017 12:42 In: _____
Customer: 8638404 THE AMBIENT GROUP LLC
Order : 950949 Camden, NJ. ABC Barrel Project
P.O. :

Tkt. No. 1006027983

Product 114203
Bank Run
S.O. Info: Camden, NJ.
Ship Ref: 327 N. Front St



	Pounds	Kilo
Gross	79,700	36,151
Tare	24,640 *	11,177
Net	55,060	24,975
	27.53 Ton	24.97

* Predetermined Tare

	UNIT	TOTALS
Material:		
Freight:		
Tax:		
Fee / Fuel:		
Other Chrg: No		

Today Tons:	820.15	Loads:
Tons To Date:	11,637.67	32
Today Tonnes	744.03	
Tonnes To Date:	10,557.52	

By acceptance of this ticket (with or without signature), driver accepts on behalf of themselves/their employer sole responsibility to ensure that the load received is within the weight limit authorized by law and shall hold seller harmless against any and all claims with respect to same CURB DELIVERY ONLY. NOT RESPONSIBLE FOR ANY DAMAGE BEYOND CURB.

Carrier : 8540415 S CUMMINS LLC

Vehicle: CUM17 Steve

License: AT979F
MaxGVW: 80,000

Received: _____ Cust: _____

Weighmaster: Colleen LeSage

P/D Status: Deliver

Customer Copy

Scale: 1



Plant: 32411

Berlin

368 New Brooklyn Road
Berlin, NJ 08009
856-809-0142

3/27/2017 12:45

In :

Customer: 8638404

THE AMBIENT GROUP LLC

Order : 950949

Camden, NJ. ABC Barrel Project

Tkt. No. 1006027985

P.O. :



Product 114203

Bank Run

S.O. Info: Camden, NJ.

Ship Ref: 327 N. Front St

	Pounds	Kilo
Gross	76,900	34,881
Tare	26,980 *	12,238
Net	49,920	22,643

24.96 Ton 22.64

* Predetermined Tare

	UNIT	TOTALS
Material:		
Freight:		
Tax:		
Fee / Fuel:		
Other Chrg: No		

Today Tons:	845.11	Loads:
Tons To Date:	11,662.63	33
Today Tonnes	766.67	
Tonnes To Date:	10,580.16	

By acceptance of this ticket (with or without signature), driver accepts on behalf of themselves/their employer sole responsibility to ensure that the load received is within the weight limit authorized by law and shall hold seller harmless against any and all claims with respect to same CURB DELIVERY ONLY. NOT RESPONSIBLE FOR ANY DAMAGE BEYOND CURB.

Carrier : 2347631 R A DIMARIA

Vehicle: DY026

DiMaria

License: AS280U

MaxGVW: 80,000

Received:

Cust: _____

Weighmaster: Colleen LeSage

P/D Status: Deliver

Customer Do Not Accept [1]

Scale: 1



Plant: 32411

Berlin

368 New Brooklyn Road
Berlin, NJ 08009
856-809-0142

3/27/2017 12:58

In :

Customer: 8638404

THE AMBIENT GROUP LLC

Order : 950949

Camden, NJ. ABC Barrel Project

Tkt. No. 1006027988

P.O. :



Product 114203

Bank Run

S.O. Info: Camden, NJ.

Ship Ref: 327 N. Front St

	Pounds	Kilo
Gross	79,900	36,242
Tare	27,580 *	12,510
Net	52,320	23,732

26.16 Ton 23.73

* Predetermined Tare

	UNIT	TOTALS
Material:		
Freight:		
Tax:		
Fee / Fuel:		
Other Chrg: No		

Today Tons:	871.27	Loads:
Tons To Date:	11,688.79	34
Today Tonnes	790.40	
Tonnes To Date:	10,603.89	

By acceptance of this ticket (with or without signature), driver accepts on behalf of themselves/their employer sole responsibility to ensure that the load received is within the weight limit authorized by law and shall hold seller harmless against any and all claims with respect to same CURB DELIVERY ONLY. NOT RESPONSIBLE FOR ANY DAMAGE BEYOND CURB.

Carrier : 3804135 MOD HAULING SERVICES

Vehicle: MOD105

MOD Hauling Services

License: AT496J

MaxGVW: 80,000

Received:

Cust: _____

Weighmaster: Colleen LeSage

P/D Status: Deliver

Customer Do Not Accept [1]

Scale: 1



Plant: 32411

Berlin

368 New Brooklyn Road
Berlin, NJ 08009
856-809-0142

3/27/2017 13:09

In :

Customer: 8638404 THE AMBIENT GROUP LLC

Order : 950949 Camden, NJ. ABC Barrel Project

P.O. :

Tkt. No. 1006027991

Product 114203

Bank Run

S.O. Info: Camden, NJ.

Ship Ref: 327 N. Front St



	Pounds	Kilo
Gross	78,880	35,779
Tare	28,340 *	12,855
Net	50,540	22,925

25.27 Ton 22.92

* Predetermined Tare

Today Tons:	896.54	Loads:
Tons To Date:	11,714.06	35
Today Tonnes	813.33	
Tonnes To Date:	10,626.82	

	UNIT	TOTALS
Material:		
Freight:		
Tax:		
Fee / Fuel:		
Other Chrg: No		

Carrier : 8040648 GJ SCOTT LLC

Vehicle: GS17 GS17

License: AT640K

MaxGVW: 80,000

Received: _____

Cust: _____

Weighmaster: Colleen LeSage

P/D Status: Deliver

Customer Copy

Scale: 1

By acceptance of this ticket (with or without signature), driver accepts on behalf of themselves/their employer sole responsibility to ensure that the load received is within the weight limit authorized by law and shall hold seller harmless against any and all claims with respect to same CURB DELIVERY ONLY. NOT RESPONSIBLE FOR ANY DAMAGE BEYOND CURB.



Plant: 32411

Berlin

368 New Brooklyn Road
Berlin, NJ 08009
856-809-0142

3/27/2017 13:17

In :

Customer: 8638404 THE AMBIENT GROUP LLC

Order : 950949 Camden, NJ. ABC Barrel Project

P.O. :

Tkt. No. 1006027993

Product 114203

Bank Run

S.O. Info: Camden, NJ.

Ship Ref: 327 N. Front St



	Pounds	Kilo
Gross	77,960	35,362
Tare	28,520 *	12,936
Net	49,440	22,426

24.72 Ton 22.43

* Predetermined Tare

Today Tons:	921.26	Loads:
Tons To Date:	11,738.78	36
Today Tonnes	835.75	
Tonnes To Date:	10,649.24	

	UNIT	TOTALS
Material:		
Freight:		
Tax:		
Fee / Fuel:		
Other Chrg: No		

Carrier : 8040648 GJ SCOTT LLC

Vehicle: GS11 GS11

License: AN120Z

MaxGVW: 80,000

Received: _____

Cust: _____

Weighmaster: Colleen LeSage

P/D Status: Deliver

Customer Copy

Scale: 1

By acceptance of this ticket (with or without signature), driver accepts on behalf of themselves/their employer sole responsibility to ensure that the load received is within the weight limit authorized by law and shall hold seller harmless against any and all claims with respect to same CURB DELIVERY ONLY. NOT RESPONSIBLE FOR ANY DAMAGE BEYOND CURB.



Plant: 32411

Berlin

368 New Brooklyn Road
Berlin, NJ 08009
856-809-0142

3/27/2017 13:50

In:

Customer: 8638404 THE AMBIENT GROUP LLC

Order: 950949 Camden, NJ. ABC Barrel Project

P.O.:

Tkt. No. 1006027996

Product 114203

Bank Run

S.O. Info: Camden, NJ.

Ship Ref: 327 N. Front St



	Pounds	Kilo
Gross	78,500	35,607
Tare	28,080 *	12,737
Net	50,420	22,870

25.21 Ton 22.87

* Predetermined Tare

	UNIT	TOTALS
Material:		
Freight:		
Tax:		
Fee / Fuel:		
Other Chrg: No		

Today Tons:	946.47	Loads:
Tons To Date:	11,763.99	37
Today Tonnes	858.62	
Tonnes To Date:	10,672.11	

Carrier: 8040648 GJ SCOTT LLC

Vehicle: GS16 GS16

License: AT639K

MaxGVW: 80,000

Received: _____

Cust: _____

Weighmaster: Colleen LeSage

P/D Status: Deliver

Customer Copy

Scale: 1

By acceptance of this ticket (with or without signature), driver accepts on behalf of themselves/their employer sole responsibility to ensure that the load received is within the weight limit authorized by law and shall hold seller harmless against any and all claims with respect to same CURB DELIVERY ONLY. NOT RESPONSIBLE FOR ANY DAMAGE BEYOND CURB.



Plant: 32411

Berlin

368 New Brooklyn Road
Berlin, NJ 08009
856-809-0142

3/27/2017 14:16

In:

Customer: 8638404 THE AMBIENT GROUP LLC

Order: 950949 Camden, NJ. ABC Barrel Project

P.O.:

Tkt. No. 1006028000

Product 114203

Bank Run

S.O. Info: Camden, NJ.

Ship Ref: 327 N. Front St



	Pounds	Kilo
Gross	78,760	35,725
Tare	27,100 *	12,292
Net	51,660	23,433

25.83 Ton 23.43

* Predetermined Tare

	UNIT	TOTALS
Material:		
Freight:		
Tax:		
Fee / Fuel:		
Other Chrg: No		

Today Tons:	972.30	Loads:
Tons To Date:	11,789.82	38
Today Tonnes	882.06	
Tonnes To Date:	10,695.54	

Carrier: 8040648 GJ SCOTT LLC

Vehicle: GS6 GS6

License: AK761C

MaxGVW: 80,000

Received: _____

Cust: _____

Weighmaster: Colleen LeSage

P/D Status: Deliver

Customer Copy

Scale: 1

By acceptance of this ticket (with or without signature), driver accepts on behalf of themselves/their employer sole responsibility to ensure that the load received is within the weight limit authorized by law and shall hold seller harmless against any and all claims with respect to same CURB DELIVERY ONLY. NOT RESPONSIBLE FOR ANY DAMAGE BEYOND CURB.



Plant: 32411

Berlin

368 New Brooklyn Road
Berlin, NJ 08009
856-809-0142

3/27/2017 14:21

In :

Customer: 8638404 THE AMBIENT GROUP LLC

Order : 950949 Camden, NJ. ABC Barrel Project

Tkt. No. 1006028001

P.O. :



Product 114203

Bank Run

S.O. Info: Camden, NJ.

Ship Ref: 327 N. Front St

	Pounds	Kilo
Gross	79,800	36,197
Tare	26,380 *	11,966
Net	53,420	24,231

26.71 Ton 24.23

* Predetermined Tare

	UNIT	TOTALS
Material:		
Freight:		
Tax:		
Fee / Fuel:		
Other Chrg: No		

Today Tons:	999.01	Loads:
Tons To Date:	11,816.53	39
Today Tonnes	906.29	
Tonnes To Date:	10,719.78	

Carrier : 2347032 ROCKY LOGIOVINO TRUCKIN

Vehicle: LR060 Rocky

License: AM637B

MaxGVW: 80,000

Received: _____

Cust: _____

Weighmaster: Colleen LeSage

P/D Status: Deliver

By acceptance of this ticket (with or without signature), driver accepts on behalf of themselves/their employer sole responsibility to ensure that the load received is within the weight limit authorized by law and shall hold seller harmless against any and all claims with respect to same
CURB DELIVERY ONLY. NOT RESPONSIBLE FOR ANY DAMAGE BEYOND CURB.

Customer Do Not Accept Scale: 1



Plant: 32411

Berlin

368 New Brooklyn Road
Berlin, NJ 08009
856-809-0142

3/28/2017 07:06 In: 6:35:45
Customer: 8638404 THE AMBIENT GROUP LLC
Order : 950949 Camden, NJ. ABC Barrel Project
P.O. :

Tkt. No. 1006028004



Product 114203
Bank Run
S.O. Info: Camden, NJ.
Ship Ref: 327 N. Front St

	Pounds	Kilo
Gross	78,020	35,389
Tare	27,300	12,383
Net	50,720	23,006
	25.36 Ton	23.01

	UNIT	TOTALS
Material:		
Freight:		
Tax:		
Fee / Fuel:		
Other Chrg: No		

Today Tons:	25.36	Loads:
Tons To Date:	11,841.89	1
Today Tonnes	23.01	
Tonnes To Date:	10,742.78	

Carrier : 8040648 GJ SCOTT LLC
Vehicle: GS11 GS11
License: AN120Z
MaxGVW: 80,000
Received: _____

Cust: _____

By acceptance of this ticket (with or without signature), driver accepts on behalf of themselves/their employer sole responsibility to ensure that the load received is within the weight limit authorized by law and shall hold seller harmless against any and all claims with respect to same
CURB DELIVERY ONLY. NOT RESPONSIBLE FOR ANY DAMAGE BEYOND CURB.

P/D Status: Deliver

Customer Do Not Accept [1] Scale: 1



Plant: 32411

Berlin

368 New Brooklyn Road
Berlin, NJ 08009
856-809-0142

3/28/2017 07:07 In: 6:37:22
Customer: 8638404 THE AMBIENT GROUP LLC
Order : 950949 Camden, NJ. ABC Barrel Project
P.O. :

Tkt. No. 1006028005



Product 114203
Bank Run
S.O. Info: Camden, NJ.
Ship Ref: 327 N. Front St

	Pounds	Kilo
Gross	79,640	36,124
Tare	28,000	12,701
Net	51,640	23,424
	25.82 Ton	23.42

	UNIT	TOTALS
Material:		
Freight:		
Tax:		
Fee / Fuel:		
Other Chrg: No		

Today Tons:	51.18	Loads:
Tons To Date:	11,867.71	2
Today Tonnes	46.43	
Tonnes To Date:	10,766.21	

Carrier : 8040648 GJ SCOTT LLC
Vehicle: GS17 GS17
License: AT640K
MaxGVW: 80,000
Received: _____

Cust: _____

By acceptance of this ticket (with or without signature), driver accepts on behalf of themselves/their employer sole responsibility to ensure that the load received is within the weight limit authorized by law and shall hold seller harmless against any and all claims with respect to same
CURB DELIVERY ONLY. NOT RESPONSIBLE FOR ANY DAMAGE BEYOND CURB.

P/D Status: Deliver

Customer Copy Scale: 1



Plant: 32411

Berlin

368 New Brooklyn Road
Berlin, NJ 08009
856-809-0142

3/28/2017 07:08 In: 6:36:28
Customer: 8638404 THE AMBIENT GROUP LLC
Order : 950949 Camden, NJ. ABC Barrel Project
P.O. :

Tkt. No. 1006028006



Product 114203
Bank Run
S.O. Info: Camden, NJ.
Ship Ref: 327 N. Front St

	Pounds	Kilo
Gross	79,880	36,233
Tare	28,700	13,018
Net	51,180	23,215

25.59 Ton 23.21

	UNIT	TOTALS
Material:		
Freight:		
Tax:		
Fee / Fuel:		
Other Chrg: No		

Today Tons:	76.77	Loads:
Tons To Date:	11,893.30	3
Today Tonnes	69.64	
Tonnes To Date:	10,789.42	

By acceptance of this ticket (with or without signature), driver accepts on behalf of themselves/their employer sole responsibility to ensure that the load received is within the weight limit authorized by law and shall hold seller harmless against any and all claims with respect to same CURB DELIVERY ONLY. NOT RESPONSIBLE FOR ANY DAMAGE BEYOND CURB.

Carrier : 8040648 GJ SCOTT LLC
Vehicle: GS15 GS15
License: AS672T
MaxGVW: 80,000
Received: CS
Weighmaster: Colleen LeSage

Cust: _____

P/D Status: Deliver

Customer Copy Scale: 1



Plant: 32411

Berlin

368 New Brooklyn Road
Berlin, NJ 08009
856-809-0142

3/28/2017 07:10 In: 6:37:42
Customer: 8638404 THE AMBIENT GROUP LLC
Order : 950949 Camden, NJ. ABC Barrel Project
P.O. :

Tkt. No. 1006028007



Product 114203
Bank Run
S.O. Info: Camden, NJ.
Ship Ref: 327 N. Front St

	Pounds	Kilo
Gross	76,020	34,482
Tare	27,380	12,419
Net	48,640	22,063

24.32 Ton 22.06

	UNIT	TOTALS
Material:		
Freight:		
Tax:		
Fee / Fuel:		
Other Chrg: No		

Today Tons:	101.09	Loads:
Tons To Date:	11,917.62	4
Today Tonnes	91.71	
Tonnes To Date:	10,811.48	

By acceptance of this ticket (with or without signature), driver accepts on behalf of themselves/their employer sole responsibility to ensure that the load received is within the weight limit authorized by law and shall hold seller harmless against any and all claims with respect to same CURB DELIVERY ONLY. NOT RESPONSIBLE FOR ANY DAMAGE BEYOND CURB.

Carrier : 8040648 GJ SCOTT LLC
Vehicle: GS9 GS9
License: AK587X
MaxGVW: 80,000
Received: CS
Weighmaster: Colleen LeSage

Cust: _____

P/D Status: Deliver

Customer Copy Scale: 1



Plant: 32411

Berlin

368 New Brooklyn Road
Berlin, NJ 08009
856-809-0142

3/28/2017 07:24 In: 6:50:27
Customer: 8638404 THE AMBIENT GROUP LLC
Order : 950949 Camden, NJ. ABC Barrel Project
P.O. :

Tkt. No. 1006028008

Product 114203
Bank Run
S.O. Info: Camden, NJ.
Ship Ref: 327 N. Front St



	Pounds	Kilo
Gross	76,400	34,654
Tare	27,640	12,537
Net	48,760	22,117

24.38 Ton 22.12

	UNIT	TOTALS
Material:		
Freight:		
Tax:		
Fee / Fuel:		
Other Chrg: No		

Today Tons:	125.47	Loads:
Tons To Date:	11,942.00	5
Today Tonnes	113.82	
Tonnes To Date:	10,833.60	

By acceptance of this ticket (with or without signature), driver accepts on behalf of themselves/their employer sole responsibility to ensure that the load received is within the weight limit authorized by law and shall hold seller harmless against any and all claims with respect to same CURB DELIVERY ONLY. NOT RESPONSIBLE FOR ANY DAMAGE BEYOND CURB.

Carrier : 3804135 MOD HAULING SERVICES
Vehicle: MOD105 MOD Hauling Services
License: AT496J
MaxGVW: 80,000
Received: 
Weighmaster: Colleen LeSage

Cust: _____

P/D Status: Deliver

Customer Copy

Scale: 1



Plant: 32411

Berlin

368 New Brooklyn Road
Berlin, NJ 08009
856-809-0142

3/28/2017 07:26 In: 6:38:01
Customer: 8638404 THE AMBIENT GROUP LLC
Order : 950949 Camden, NJ. ABC Barrel Project
P.O. :

Tkt. No. 1006028009

Product 114203
Bank Run
S.O. Info: Camden, NJ.
Ship Ref: 327 N. Front St



	Pounds	Kilo
Gross	77,740	35,262
Tare	28,060	12,728
Net	49,680	22,534

24.84 Ton 22.53

	UNIT	TOTALS
Material:		
Freight:		
Tax:		
Fee / Fuel:		
Other Chrg: No		

Today Tons:	150.31	Loads:
Tons To Date:	11,966.84	6
Today Tonnes	136.36	
Tonnes To Date:	10,856.13	

By acceptance of this ticket (with or without signature), driver accepts on behalf of themselves/their employer sole responsibility to ensure that the load received is within the weight limit authorized by law and shall hold seller harmless against any and all claims with respect to same CURB DELIVERY ONLY. NOT RESPONSIBLE FOR ANY DAMAGE BEYOND CURB.

Carrier : 8040648 GJ SCOTT LLC
Vehicle: GS4 GS4
License: AJ118L
MaxGVW: 80,000
Received: 
Weighmaster: Colleen LeSage

Cust: _____

P/D Status: Deliver

Customer Do Not Accept [1]

Scale: 1



Plant: 32411

Berlin

368 New Brooklyn Road
Berlin, NJ 08009
856-809-0142

3/28/2017 07:27

In: 6:38:32

Customer: 8638404

THE AMBIENT GROUP LLC

Order : 950949

Camden, NJ. ABC Barrel Project

Tkt. No. 1006028010

P.O. :

Product 114203

Bank Run

S.O. Info: Camden, NJ.

Ship Ref: 327 N. Front St



	Pounds	Kilo
Gross	76,380	34,645
Tare	27,920	12,664
Net	48,460	21,981

24.23 Ton 21.98

UNIT	TOTALS
Material:	
Freight:	
Tax:	
Fee / Fuel:	
Other Chrg: No	

Today Tons:	174.54	Loads:
Tons To Date:	11,991.07	7
Today Tonnes	158.34	
Tonnes To Date:	10,878.12	

Carrier : 9249110 CLM CONTRACTING LLC

Vehicle: CLM6

CLM6

License: AT597T

MaxGVW: 80,000

Received: _____

Weighmaster: Colleen LeSage

Cust: _____

P/D Status: Deliver

By acceptance of this ticket (with or without signature), driver accepts on behalf of themselves/their employer sole responsibility to ensure that the load received is within the weight limit authorized by law and shall hold seller harmless against any and all claims with respect to same CURB DELIVERY ONLY. NOT RESPONSIBLE FOR ANY DAMAGE BEYOND CURB.

Customer Do Not Accept [1] Scale: 1



Plant: 32411

Berlin

368 New Brooklyn Road
Berlin, NJ 08009
856-809-0142

3/28/2017 07:29

In: 6:43:54

Customer: 8638404

THE AMBIENT GROUP LLC

Order : 950949

Camden, NJ. ABC Barrel Project

Tkt. No. 1006028011

P.O. :

Product 114203

Bank Run

S.O. Info: Camden, NJ.

Ship Ref: 327 N. Front St



	Pounds	Kilo
Gross	78,440	35,580
Tare	28,100	12,746
Net	50,340	22,834

25.17 Ton 22.83

UNIT	TOTALS
Material:	
Freight:	
Tax:	
Fee / Fuel:	
Other Chrg: No	

Today Tons:	199.71	Loads:
Tons To Date:	12,016.24	8
Today Tonnes	181.17	
Tonnes To Date:	10,900.95	

Carrier : 8040648 GJ SCOTT LLC

Vehicle: GS16

GS16

License: AT639K

MaxGVW: 80,000

Received: _____

Weighmaster: Colleen LeSage

Cust: _____

P/D Status: Deliver

By acceptance of this ticket (with or without signature), driver accepts on behalf of themselves/their employer sole responsibility to ensure that the load received is within the weight limit authorized by law and shall hold seller harmless against any and all claims with respect to same CURB DELIVERY ONLY. NOT RESPONSIBLE FOR ANY DAMAGE BEYOND CURB.

Customer Copy Scale: 1



Plant: 32411

Berlin

368 New Brooklyn Road
Berlin, NJ 08009
856-809-0142

3/28/2017 07:32 In: 6:54:34
Customer: 8638404 THE AMBIENT GROUP LLC
Order: 950949 Camden, NJ, ABC Barrel Project
P.O.:

Tkt. No. 1006028012



Product 114203
Bank Run
S.O. Info: Camden, NJ.
Ship Ref: 327 N. Front St

	Pounds	Kilo
Gross	76,920	34,890
Tare	23,080	10,469
Net	53,840	24,421
	26.92 Ton	24.42

	UNIT	TOTALS
Material:		
Freight:		
Tax:		
Fee / Fuel:		
Other Chrg:	No	

Today Tons:	226.63	Loads:
Tons To Date:	12,043.16	9
Today Tonnes	205.60	
Tonnes To Date:	10,925.37	

By acceptance of this ticket (with or without signature), driver accepts on behalf of themselves/their employer sole responsibility to ensure that the load received is within the weight limit authorized by law and shall hold seller harmless against any and all claims with respect to same
CURB DELIVERY ONLY. NOT RESPONSIBLE FOR ANY DAMAGE BEYOND CURB.

Carrier: 9285292 BLUESTONE CONTRACTING C
Vehicle: SB11 XDUX86
License: XDUX86
MaxGVW: 80,000
Received: _____
Weighmaster: Colleen LeSage

Cust: _____

P/D Status: Deliver

Customer Copy Scale: 1



Plant: 32411

Berlin

368 New Brooklyn Road
Berlin, NJ 08009
856-809-0142

3/28/2017 08:59 In:
Customer: 8638404 THE AMBIENT GROUP LLC
Order: 950949 Camden, NJ, ABC Barrel Project
P.O.:

Tkt. No. 1006028025



Product 114203
Bank Run
S.O. Info: Camden, NJ.
Ship Ref: 327 N. Front St

	Pounds	Kilo
Gross	79,440	36,033
Tare	28,700 *	13,018
Net	50,740	23,015
	25.37 Ton	23.02

* Predetermined Tare

	UNIT	TOTALS
Material:		
Freight:		
Tax:		
Fee / Fuel:		
Other Chrg:	No	

Today Tons:	252.00	Loads:
Tons To Date:	12,068.53	10
Today Tonnes	228.61	
Tonnes To Date:	10,948.39	

By acceptance of this ticket (with or without signature), driver accepts on behalf of themselves/their employer sole responsibility to ensure that the load received is within the weight limit authorized by law and shall hold seller harmless against any and all claims with respect to same
CURB DELIVERY ONLY. NOT RESPONSIBLE FOR ANY DAMAGE BEYOND CURB.

Carrier: 8040648 GJ SCOTT LLC
Vehicle: GS15 GS15
License: AS672T
MaxGVW: 80,000
Received: _____

Cust: _____

Weighmaster: Colleen LeSage
REPRINT

P/D Status: Deliver

Customer Copy Scale: 1



Plant: 32411

Berlin

368 New Brooklyn Road
Berlin, NJ 08009
856-809-0142

3/28/2017 09:05 In :
Customer: 8638404 THE AMBIENT GROUP LLC
Order : 950949 Camden, NJ. ABC Barrel Project
P.O. :

Tkt. No. 1006028026

Product 114203
Bank Run
S.O. Info: Camden, NJ.
Ship Ref: 327 N. Front St



	Pounds	Kilo
Gross	79,080	35,870
Tare	27,300 *	12,383
Net	51,780	23,487

25.89 Ton 23.49

* Predetermined Tare

	UNIT	TOTALS
Material:		
Freight:		
Tax:		
Fee / Fuel:		
Other Chrg: No		

Today Tons:	277.89	Loads:
Tons To Date:	12,069.05	11
Today Tonnes	252.10	
Tonnes To Date:	10,948.86	

By acceptance of this ticket (with or without signature), driver accepts on behalf of themselves/their employer sole responsibility to ensure that the load received is within the weight limit authorized by law and shall hold seller harmless against any and all claims with respect to same CURB DELIVERY ONLY. NOT RESPONSIBLE FOR ANY DAMAGE BEYOND CURB.

Carrier : 8040648 GJ SCOTT LLC
Vehicle: GS11 GS11
License: AN120Z
MaxGVW: 80,000

Received: _____ Cust: _____

Weighmaster: Colleen LeSage

P/D Status: Deliver

Customer Copy

Scale: 1



Plant: 32411

Berlin

368 New Brooklyn Road
Berlin, NJ 08009
856-809-0142

3/28/2017 09:07 In :
Customer: 8638404 THE AMBIENT GROUP LLC
Order : 950949 Camden, NJ. ABC Barrel Project
P.O. :

Tkt. No. 1006028027

Product 114203
Bank Run
S.O. Info: Camden, NJ.
Ship Ref: 327 N. Front St



	Pounds	Kilo
Gross	76,760	34,818
Tare	27,380 *	12,419
Net	49,380	22,398

24.69 Ton 22.40

* Predetermined Tare

	UNIT	TOTALS
Material:		
Freight:		
Tax:		
Fee / Fuel:		
Other Chrg: No		

Today Tons:	302.58	Loads:
Tons To Date:	12,093.74	12
Today Tonnes	274.50	
Tonnes To Date:	10,971.26	

By acceptance of this ticket (with or without signature), driver accepts on behalf of themselves/their employer sole responsibility to ensure that the load received is within the weight limit authorized by law and shall hold seller harmless against any and all claims with respect to same CURB DELIVERY ONLY. NOT RESPONSIBLE FOR ANY DAMAGE BEYOND CURB.

Carrier : 8040648 GJ SCOTT LLC
Vehicle: GS9 GS9
License: AK587X
MaxGVW: 80,000

Received: _____ Cust: _____

Weighmaster: Colleen LeSage

P/D Status: Deliver

Customer Copy

Scale: 1



Plant: 32411

Berlin

368 New Brooklyn Road
Berlin, NJ 08009
856-809-0142

3/28/2017 09:08

In:

Customer: 8638404 THE AMBIENT GROUP LLC

Order: 950949 Camden, NJ. ABC Barrel Project

P.O.:

Tkt. No. 1006028028

Product 114203

Bank Run

S.O. Info: Camden, NJ.

Ship Ref: 327 N. Front St



	Pounds	Kilo
Gross	75,880	34,419
Tare	27,640 *	12,537
Net	48,240	21,881

24.12 Ton 21.88

* Predetermined Tare

Today Tons:	326.70	Loads:
Tons To Date:	12,117.86	13
Today Tonnes	296.38	
Tonnes To Date:	10,993.14	

	UNIT	TOTALS
Material:		
Freight:		
Tax:		
Fee / Fuel:		
Other Chrg:	No	

Carrier: 3804135 MOD HAULING SERVICES

Vehicle: MOD105 MOD Hauling Services

License: AT496J

MaxGVW: 80,000

Received: [Signature]

Weighmaster: Colleen LeSage

Cust: [Signature]

P/D Status: Deliver

By acceptance of this ticket (with or without signature), driver accepts on behalf of themselves/their employer sole responsibility to ensure that the load received is within the weight limit authorized by law and shall hold seller harmless against any and all claims with respect to same CURB DELIVERY ONLY. NOT RESPONSIBLE FOR ANY DAMAGE BEYOND CURB.

Customer Copy

Scale: 1



Plant: 32411

Berlin

368 New Brooklyn Road
Berlin, NJ 08009
856-809-0142

3/28/2017 09:10

In:

Customer: 8638404 THE AMBIENT GROUP LLC

Order: 950949 Camden, NJ. ABC Barrel Project

P.O.:

Tkt. No. 1006028029

Product 114203

Bank Run

S.O. Info: Camden, NJ.

Ship Ref: 327 N. Front St



	Pounds	Kilo
Gross	77,540	35,172
Tare	28,000 *	12,701
Net	49,540	22,471

24.77 Ton 22.47

* Predetermined Tare

Today Tons:	351.47	Loads:
Tons To Date:	12,142.63	14
Today Tonnes	318.85	
Tonnes To Date:	11,015.61	

	UNIT	TOTALS
Material:		
Freight:		
Tax:		
Fee / Fuel:		
Other Chrg:	No	

Carrier: 8040648 GJ SCOTT LLC

Vehicle: GS17 GS17

License: AT640K

MaxGVW: 80,000

Received: _____

Weighmaster: Colleen LeSage

Cust: _____

P/D Status: Deliver

By acceptance of this ticket (with or without signature), driver accepts on behalf of themselves/their employer sole responsibility to ensure that the load received is within the weight limit authorized by law and shall hold seller harmless against any and all claims with respect to same CURB DELIVERY ONLY. NOT RESPONSIBLE FOR ANY DAMAGE BEYOND CURB.

Customer Copy

Scale: 1



Plant: 32411

Berlin

368 New Brooklyn Road
Berlin, NJ 08009
856-809-0142

LA

3/28/2017 09:11

In: 8:47:01

Customer: 8638404 THE AMBIENT GROUP LLC

Order: 950949 Camden, NJ. ABC Barrel Project

P.O.:

Tkt. No. 1006028030

Product 114203



Bank Run

S.O. Info: Camden, NJ.

Ship Ref: 327 N. Front St

	Pounds	Kilo
Gross	75,280	34,146
Tare	25,080	11,376
Net	50,200	22,770

25.10 Ton 22.77

	UNIT	TOTALS
Material:		
Freight:		
Tax:		
Fee / Fuel:		
Other Chrg: No		

Today Tons:	376.57	Loads:
Tons To Date:	12,167.73	15
Today Tonnes	341.62	
Tonnes To Date:	11,038.38	

Carrier: 8515471 CALLE TRUCKING LLC

Vehicle: CALLE12 Calle Trucking

License: AG43568

MaxGVW: 80,000

Received: _____

Cust: _____

Weighmaster: Colleen LeSage

P/D Status: Deliver

Customer Do Not Accept [1]

Scale: 1

By acceptance of this ticket (with or without signature), driver accepts on behalf of themselves/their employer sole responsibility to ensure that the load received is within the weight limit authorized by law and shall hold seller harmless against any and all claims with respect to same CURB DELIVERY ONLY. NOT RESPONSIBLE FOR ANY DAMAGE BEYOND CURB.



Plant: 32411

Berlin

368 New Brooklyn Road
Berlin, NJ 08009
856-809-0142

3/28/2017 09:33

In:

Customer: 8638404 THE AMBIENT GROUP LLC

Order: 950949 Camden, NJ. ABC Barrel Project

P.O.:

Tkt. No. 1006028035

Product 114203



Bank Run

S.O. Info: Camden, NJ.

Ship Ref: 327 N. Front St

	Pounds	Kilo
Gross	79,060	35,861
Tare	28,060 *	12,728
Net	51,000	23,133

25.50 Ton 23.13

* Predetermined Tare

	UNIT	TOTALS
Material:		
Freight:		
Tax:		
Fee / Fuel:		
Other Chrg: No		

Today Tons:	402.07	Loads:
Tons To Date:	12,193.23	16
Today Tonnes	364.75	
Tonnes To Date:	11,061.51	

Carrier: 8040648 GJ SCOTT LLC

Vehicle: GS4 GS4

License: AJ118L

MaxGVW: 80,000

Received: _____ *mm*

Cust: _____

Weighmaster: Colleen LeSage

P/D Status: Deliver

Customer Do Not Accept [1]

Scale: 1

By acceptance of this ticket (with or without signature), driver accepts on behalf of themselves/their employer sole responsibility to ensure that the load received is within the weight limit authorized by law and shall hold seller harmless against any and all claims with respect to same CURB DELIVERY ONLY. NOT RESPONSIBLE FOR ANY DAMAGE BEYOND CURB.



Plant: 32411

Berlin

368 New Brooklyn Road
Berlin, NJ 08009
856-809-0142

3/28/2017 09:44 In :
Customer: 8638404 THE AMBIENT GROUP LLC
Order : 950949 Camden, NJ. ABC Barrel Project
P.O. :

Tkt. No. 1006028037

Product 114203
Bank Run
S.O. Info: Camden, NJ.
Ship Ref: 327 N. Front St



	Pounds	Kilo
Gross	78,920	35,798
Tare	28,100 *	12,746
Net	50,820	23,052

25.41 Ton 23.05

* Predetermined Tare

	UNIT	TOTALS
Material:		
Freight:		
Tax:		
Fee / Fuel:		
Other Chrg: No		

Today Tons:	427.48	Loads:
Tons To Date:	12,218.64	17
Today Tonnes	387.80	
Tonnes To Date:	11,084.56	

By acceptance of this ticket (with or without signature), driver accepts on behalf of themselves/their employer sole responsibility to ensure that the load received is within the weight limit authorized by law and shall hold seller harmless against any and all claims with respect to same CURB DELIVERY ONLY. NOT RESPONSIBLE FOR ANY DAMAGE BEYOND CURB.

Carrier : 8040648 GJ SCOTT LLC

Vehicle: GS16 GS16

License: AT639K

MaxGVW: 80,000

Received: _____

Weighmaster: Colleen LeSage

Cust: _____

P/D Status: Deliver

Customer Copy

Scale: 1



Plant: 32411

Berlin

368 New Brooklyn Road
Berlin, NJ 08009
856-809-0142

3/28/2017 10:02 In :
Customer: 8638404 THE AMBIENT GROUP LLC
Order : 950949 Camden, NJ. ABC Barrel Project
P.O. :

Tkt. No. 1006028040

Product 114203
Bank Run
S.O. Info: Camden, NJ.
Ship Ref: 327 N. Front St



	Pounds	Kilo
Gross	74,980	34,010
Tare	23,080 *	10,469
Net	51,900	23,541

25.95 Ton 23.54

* Predetermined Tare

	UNIT	TOTALS
Material:		
Freight:		
Tax:		
Fee / Fuel:		
Other Chrg: No		

Today Tons:	453.43	Loads:
Tons To Date:	12,244.59	18
Today Tonnes	411.34	
Tonnes To Date:	11,108.11	

By acceptance of this ticket (with or without signature), driver accepts on behalf of themselves/their employer sole responsibility to ensure that the load received is within the weight limit authorized by law and shall hold seller harmless against any and all claims with respect to same CURB DELIVERY ONLY. NOT RESPONSIBLE FOR ANY DAMAGE BEYOND CURB.

Carrier : 9285292 BLUESTONE CONTRACTING C

Vehicle: SB11 XDUX86

License: XDUX86

MaxGVW: 80,000

Received: _____

Weighmaster: Colleen LeSage

Cust: _____

P/D Status: Deliver

Customer Copy

Scale: 1



Plant: 32411

Berlin

368 New Brooklyn Road
Berlin, NJ 08009
856-809-0142

3/28/2017 10:28

In:

Customer: 8638404 THE AMBIENT GROUP LLC

Order: 950949 Camden, NJ. ABC Barrel Project

P.O.:

Tkt. No. 1006028047

Product 114203

Bank Run

S.O. Info: Camden, NJ.

Ship Ref: 327 N. Front St



	Pounds	Kilo
Gross	77,440	35,126
Tare	27,380 *	12,419
Net	50,060	22,707

25.03 Ton 22.71

* Predetermined Tare

	UNIT	TOTALS
Material:		
Freight:		
Tax:		
Fee / Fuel:		
Other Chrg:	No	

Today Tons:	478.46	Loads:
Tons To Date:	12,269.62	19
Today Tonnes	434.05	
Tonnes To Date:	11,130.81	

Carrier: 8040648 GJ SCOTT LLC

Vehicle: GS9 GS9

License: AK587X

MaxGVW: 80,000

Received:

Weighmaster: Colleen LeSage

By acceptance of this ticket (with or without signature), driver accepts on behalf of themselves/their employer sole responsibility to ensure that the load received is within the weight limit authorized by law and shall hold seller harmless against any and all claims with respect to same CURB DELIVERY ONLY. NOT RESPONSIBLE FOR ANY DAMAGE BEYOND CURB.

Cust:

P/D Status: Deliver

Customer Copy

Scale: 1



Plant: 32411

Berlin

368 New Brooklyn Road
Berlin, NJ 08009
856-809-0142

3/28/2017 10:31

In:

Customer: 8638404 THE AMBIENT GROUP LLC

Order: 950949 Camden, NJ. ABC Barrel Project

P.O.:

Tkt. No. 1006028048

Product 114203

Bank Run

S.O. Info: Camden, NJ.

Ship Ref: 327 N. Front St



	Pounds	Kilo
Gross	78,060	35,407
Tare	27,640 *	12,537
Net	50,420	22,870

25.21 Ton 22.87

* Predetermined Tare

	UNIT	TOTALS
Material:		
Freight:		
Tax:		
Fee / Fuel:		
Other Chrg:	No	

Today Tons:	503.67	Loads:
Tons To Date:	12,294.83	20
Today Tonnes	456.92	
Tonnes To Date:	11,153.68	

Carrier: 3804135 MOD HAULING SERVICES

Vehicle: MOD105 MOD Hauling Services

License: AT496J

MaxGVW: 80,000

Received:

Weighmaster: Colleen LeSage

By acceptance of this ticket (with or without signature), driver accepts on behalf of themselves/their employer sole responsibility to ensure that the load received is within the weight limit authorized by law and shall hold seller harmless against any and all claims with respect to same CURB DELIVERY ONLY. NOT RESPONSIBLE FOR ANY DAMAGE BEYOND CURB.

Cust:

P/D Status: Deliver

Customer Copy

Scale: 1



Plant: 32411

Berlin

368 New Brooklyn Road
Berlin, NJ 08009
856-809-0142

3/28/2017 10:34

In:

Customer: 8638404 THE AMBIENT GROUP LLC

Order: 950949 Camden, NJ. ABC Barrel Project

P.O.:

Tkt. No. 1006028049

Product 114203

Bank Run

S.O. Info: Camden, NJ.

Ship Ref: 327 N. Front St



	Pounds	Kilo
Gross	78,840	35,761
Tare	28,000 *	12,701
Net	50,840	23,061

25.42 Ton 23.06

* Predetermined Tare

	UNIT	TOTALS
Material:		
Freight:		
Tax:		
Fee / Fuel:		
Other Chrg:	No	

Today Tons:	529.09	Loads:
Tons To Date:	12,320.25	21
Today Tonnes	479.98	
Tonnes To Date:	11,176.74	

By acceptance of this ticket (with or without signature), driver accepts on behalf of themselves/their employer sole responsibility to ensure that the load received is within the weight limit authorized by law and shall hold seller harmless against any and all claims with respect to same CURB DELIVERY ONLY. NOT RESPONSIBLE FOR ANY DAMAGE BEYOND CURB.

Carrier: 8040648 GJ SCOTT LLC

Vehicle: GS17 GS17

License: AT640K

MaxGVW: 80,000

Received:

Cust: _____

Weighmaster: Colleen LeSage

P/D Status: Deliver

Customer Copy

Scale: 1



Plant: 32411

Berlin

368 New Brooklyn Road
Berlin, NJ 08009
856-809-0142

3/28/2017 10:37

In:

Customer: 8638404 THE AMBIENT GROUP LLC

Order: 950949 Camden, NJ. ABC Barrel Project

P.O.:

Tkt. No. 1006028050

Product 114203

Bank Run

S.O. Info: Camden, NJ.

Ship Ref: 327 N. Front St



	Pounds	Kilo
Gross	78,840	35,761
Tare	28,700 *	13,018
Net	50,140	22,743

25.07 Ton 22.74

* Predetermined Tare

	UNIT	TOTALS
Material:		
Freight:		
Tax:		
Fee / Fuel:		
Other Chrg:	No	

Today Tons:	554.16	Loads:
Tons To Date:	12,345.32	22
Today Tonnes	502.73	
Tonnes To Date:	11,199.49	

By acceptance of this ticket (with or without signature), driver accepts on behalf of themselves/their employer sole responsibility to ensure that the load received is within the weight limit authorized by law and shall hold seller harmless against any and all claims with respect to same CURB DELIVERY ONLY. NOT RESPONSIBLE FOR ANY DAMAGE BEYOND CURB.

Carrier: 8040648 GJ SCOTT LLC

Vehicle: GS15 GS15

License: AS672T

MaxGVW: 80,000

Received:

Cust: _____

Weighmaster: Colleen LeSage

P/D Status: Deliver

Customer Copy

Scale: 1



Plant: 32411

Berlin

368 New Brooklyn Road
Berlin, NJ 08009
856-809-0142

3/28/2017 10:38 In :
Customer: 8638404 THE AMBIENT GROUP LLC
Order : 950949 Camden, NJ. ABC Barrel Project
P.O. :

Tkt. No. 1006028051

Product 114203
Bank Run
S.O. Info: Camden, NJ.
Ship Ref: 327 N. Front St



	Pounds	Kilo
Gross	78,280	35,507
Tare	27,300 *	12,383
Net	50,980	23,124

25.49 Ton 23.12

* Predetermined Tare

	UNIT	TOTALS
Material:		
Freight:		
Tax:		
Fee / Fuel:		
Other Chrg: No		

Today Tons:	579.65	Loads:
Tons To Date:	12,370.81	23
Today Tonnes	525.85	
Tonnes To Date:	11,222.61	

Carrier : 8040648 GJ SCOTT LLC
Vehicle: GS11 GS11
License: AN120Z
MaxGVW: 80,000

By acceptance of this ticket (with or without signature), driver accepts on behalf of themselves/their employer sole responsibility to ensure that the load received is within the weight limit authorized by law and shall hold seller harmless against any and all claims with respect to same
CURB DELIVERY ONLY. NOT RESPONSIBLE FOR ANY DAMAGE BEYOND CURB.

Received: _____ Cust: _____

Weighmaster: Colleen LeSage

P/D Status: Deliver

Customer Copy

Scale: 1



Plant: 32411

Berlin

368 New Brooklyn Road
Berlin, NJ 08009
856-809-0142

3/28/2017 10:47 In :
Customer: 8638404 THE AMBIENT GROUP LLC
Order : 950949 Camden, NJ. ABC Barrel Project
P.O. :

Tkt. No. 1006028053

Product 114203
Bank Run
S.O. Info: Camden, NJ.
Ship Ref: 327 N. Front St



	Pounds	Kilo
Gross	74,680	33,874
Tare	25,080 *	11,376
Net	49,600	22,498

24.80 Ton 22.50

* Predetermined Tare

	UNIT	TOTALS
Material:		
Freight:		
Tax:		
Fee / Fuel:		
Other Chrg: No		

Today Tons:	604.45	Loads:
Tons To Date:	12,395.61	24
Today Tonnes	548.35	
Tonnes To Date:	11,245.11	

By acceptance of this ticket (with or without signature), driver accepts on behalf of themselves/their employer sole responsibility to ensure that the load received is within the weight limit authorized by law and shall hold seller harmless against any and all claims with respect to same
CURB DELIVERY ONLY. NOT RESPONSIBLE FOR ANY DAMAGE BEYOND CURB.

Carrier : 8515471 CALLE TRUCKING LLC
Vehicle: CALLE12 Calle Trucking
License: AG43568
MaxGVW: 80,000

Received: _____ Cust: _____

Weighmaster: Colleen LeSage

P/D Status: Deliver

Customer Copy

Scale: 1



Plant: 32411

Berlin

368 New Brooklyn Road
Berlin, NJ 08009
856-809-0142

3/28/2017 11:02 In:
Customer: 8638404 THE AMBIENT GROUP LLC
Order : 950949 Camden, NJ. ABC Barrel Project
P.O. :

Tkt. No. 1006028056

Product 114203
Bank Run
S.O. Info: Camden, NJ.
Ship Ref: 327 N. Front St



	Pounds	Kilo
Gross	78,580	35,643
Tare	28,100 *	12,746
Net	50,480	22,897

25.24 Ton 22.90

* Predetermined Tare

	UNIT	TOTALS
Material:		
Freight:		
Tax:		
Fee / Fuel:		
Other Chrg: No		

Today Tons:	629.69	Loads:
Tons To Date:	12,420.85	25
Today Tonnes	571.25	
Tonnes To Date:	11,268.01	

Carrier : 8040648 GJ SCOTT LLC
Vehicle: GS16 GS16
License: AT639K
MaxGVW: 80,000

By acceptance of this ticket (with or without signature), driver accepts on behalf of themselves/their employer sole responsibility to ensure that the load received is within the weight limit authorized by law and shall hold seller harmless against any and all claims with respect to same CURB DELIVERY ONLY. NOT RESPONSIBLE FOR ANY DAMAGE BEYOND CURB.

Received: 
Weighmaster: Colleen LeSage

Cust: _____

P/D Status: Deliver

Customer Copy

Scale: 1



Plant: 32411

Berlin

368 New Brooklyn Road
Berlin, NJ 08009
856-809-0142

3/28/2017 11:08 In:
Customer: 8638404 THE AMBIENT GROUP LLC
Order : 950949 Camden, NJ. ABC Barrel Project
P.O. :

Tkt. No. 1006028058

Product 114203
Bank Run
S.O. Info: Camden, NJ.
Ship Ref: 327 N. Front St



	Pounds	Kilo
Gross	78,280	35,507
Tare	28,060 *	12,728
Net	50,220	22,779

25.11 Ton 22.78

* Predetermined Tare

	UNIT	TOTALS
Material:		
Freight:		
Tax:		
Fee / Fuel:		
Other Chrg: No		

Today Tons:	654.80	Loads:
Tons To Date:	12,445.96	26
Today Tonnes	594.02	
Tonnes To Date:	11,290.78	

Carrier : 8040648 GJ SCOTT LLC
Vehicle: GS4 GS4
License: AJ118L
MaxGVW: 80,000

By acceptance of this ticket (with or without signature), driver accepts on behalf of themselves/their employer sole responsibility to ensure that the load received is within the weight limit authorized by law and shall hold seller harmless against any and all claims with respect to same CURB DELIVERY ONLY. NOT RESPONSIBLE FOR ANY DAMAGE BEYOND CURB.

Received: 
Weighmaster: Colleen LeSage

Cust: _____

P/D Status: Deliver

Customer Do Not Accept [1]

Scale: 1



Plant: 32411

Berlin

368 New Brooklyn Road
Berlin, NJ 08009
856-809-0142

3/28/2017 11:47 In:
Customer: 8638404 THE AMBIENT GROUP LLC
Order: 950949 Camden, NJ. ABC Barrel Project
P.O.:

Tkt. No. 1006028060

Product 114203
Bank Run
S.O. Info: Camden, NJ.
Ship Ref: 327 N. Front St



	Pounds	Kilo
Gross	76,840	34,854
Tare	23,080 *	10,469
Net	53,760	24,385

26.88 Ton 24.39

* Predetermined Tare

	UNIT	TOTALS
Material:		
Freight:		
Tax:		
Fee / Fuel:		
Other Chrg: No		

Today Tons:	681.68	Loads:
Tons To Date:	12,472.84	27
Today Tonnes	618.41	
Tonnes To Date:	11,315.17	

Carrier: 9285292 BLUESTONE CONTRACTING C
Vehicle: SB11 XDUX86
License: XDUX86
MaxGVW: 80,000

By acceptance of this ticket (with or without signature), driver accepts on behalf of themselves/their employer sole responsibility to ensure that the load received is within the weight limit authorized by law and shall hold seller harmless against any and all claims with respect to same CURB DELIVERY ONLY. NOT RESPONSIBLE FOR ANY DAMAGE BEYOND CURB.

Received: 
Weighmaster: Colleen LeSage

Cust: _____

P/D Status: Deliver

Customer Copy

Scale: 1



Plant: 32411

Berlin

368 New Brooklyn Road
Berlin, NJ 08009
856-809-0142

3/28/2017 12:00 In: 11:42:51
Customer: 8638404 THE AMBIENT GROUP LLC
Order: 950949 Camden, NJ. ABC Barrel Project
P.O.:

Tkt. No. 1006028061

Product 114203
Bank Run
S.O. Info: Camden, NJ.
Ship Ref: 327 N. Front St



	Pounds	Kilo
Gross	79,240	35,943
Tare	28,700	13,018
Net	50,540	22,925

25.27 Ton 22.92

	UNIT	TOTALS
Material:		
Freight:		
Tax:		
Fee / Fuel:		
Other Chrg: No		

Today Tons:	706.95	Loads:
Tons To Date:	12,498.11	28
Today Tonnes	641.33	
Tonnes To Date:	11,338.09	

By acceptance of this ticket (with or without signature), driver accepts on behalf of themselves/their employer sole responsibility to ensure that the load received is within the weight limit authorized by law and shall hold seller harmless against any and all claims with respect to same CURB DELIVERY ONLY. NOT RESPONSIBLE FOR ANY DAMAGE BEYOND CURB.

Carrier: 8040648 GJ SCOTT LLC
Vehicle: GS14 GS14
License: As672T
MaxGVW: 80,000

Received: _____
Weighmaster: Colleen LeSage

Cust: _____

P/D Status: Deliver

Customer Copy

Scale: 1



Plant: 32411

Berlin

368 New Brooklyn Road
Berlin, NJ 08009
856-809-0142

3/28/2017 12:01

In :

Customer: 8638404 THE AMBIENT GROUP LLC

Order : 950949 Camden, NJ. ABC Barrel Project

P.O. :

Tkt. No. 1006028062

Product 114203

Bank Run

S.O. Info: Camden, NJ.

Ship Ref: 327 N. Front St



	Pounds	Kilo
Gross	79,200	35,925
Tare	27,640 *	12,537
Net	51,560	23,387

25.78 Ton 23.39

* Predetermined Tare

	UNIT	TOTALS
Material:		
Freight:		
Tax:		
Fee / Fuel:		
Other Chrg: No		

Today Tons:	732.73	Loads:
Tons To Date:	12,523.89	29
Today Tonnes	664.72	
Tonnes To Date:	11,361.48	

Carrier : 3804135 MOD HAULING SERVICES

Vehicle: MOD105 MOD Hauling Services

License: AT4961

MaxGVW: 80,000

Received:

Weighmaster: Colleen LeSage

By acceptance of this ticket (with or without signature), driver accepts on behalf of themselves/their employer sole responsibility to ensure that the load received is within the weight limit authorized by law and shall hold seller harmless against any and all claims with respect to same CURB DELIVERY ONLY. NOT RESPONSIBLE FOR ANY DAMAGE BEYOND CURB.

Cust: _____

P/D Status: Deliver

Customer Copy

Scale: 1



Plant: 32411

Berlin

368 New Brooklyn Road
Berlin, NJ 08009
856-809-0142

3/28/2017 12:06

In :

Customer: 8638404 THE AMBIENT GROUP LLC

Order : 950949 Camden, NJ. ABC Barrel Project

P.O. :

Tkt. No. 1006028063

Product 114203

Bank Run

S.O. Info: Camden, NJ.

Ship Ref: 327 N. Front St



	Pounds	Kilo
Gross	78,020	35,389
Tare	27,380 *	12,419
Net	50,640	22,970

25.32 Ton 22.97

* Predetermined Tare

	UNIT	TOTALS
Material:		
Freight:		
Tax:		
Fee / Fuel:		
Other Chrg: No		

Today Tons:	758.05	Loads:
Tons To Date:	12,549.21	30
Today Tonnes	687.69	
Tonnes To Date:	11,384.45	

Carrier : 8040648 GJ SCOTT LLC

Vehicle: GS9 GS9

License: AK587X

MaxGVW: 80,000

Received:

Weighmaster: Colleen LeSage

By acceptance of this ticket (with or without signature), driver accepts on behalf of themselves/their employer sole responsibility to ensure that the load received is within the weight limit authorized by law and shall hold seller harmless against any and all claims with respect to same CURB DELIVERY ONLY. NOT RESPONSIBLE FOR ANY DAMAGE BEYOND CURB.

Cust: _____

P/D Status: Deliver

Customer Copy

Scale: 1



Plant: 32411

Berlin

368 New Brooklyn Road
Berlin, NJ 08009
856-809-0142

3/28/2017 12:07

In :

Customer: 8638404 THE AMBIENT GROUP LLC

Order : 950949 Camden, NJ. ABC Barrel Project

P.O. :

Tkt. No. 1006028064

Product 114203

Bank Run

S.O. Info: Camden, NJ.

Ship Ref: 327 N. Front St



	Pounds	Kilo
Gross	78,940	35,807
Tare	28,000 *	12,701
Net	50,940	23,106

25.47 Ton 23.11

* Predetermined Tare

	UNIT	TOTALS
Material:		
Freight:		
Tax:		
Fee / Fuel:		
Other Chrg:	No	

Today Tons:	783.52	Loads:
Tons To Date:	12,574.68	31
Today Tonnes	710.80	
Tonnes To Date:	11,407.56	

By acceptance of this ticket (with or without signature), driver accepts on behalf of themselves/their employer sole responsibility to ensure that the load received is within the weight limit authorized by law and shall hold seller harmless against any and all claims with respect to same CURB DELIVERY ONLY. NOT RESPONSIBLE FOR ANY DAMAGE BEYOND CURB.

Carrier : 8040648 GJ SCOTT LLC

Vehicle: GS17 GS17

License: AT640K

MaxGVW: 80,000

Received: _____

Cust: _____

Weighmaster: Colleen LeSage

P/D Status: Deliver

Customer Copy

Scale: 1



Plant: 32411

Berlin

368 New Brooklyn Road
Berlin, NJ 08009
856-809-0142

3/28/2017 12:09

In :

Customer: 8638404 THE AMBIENT GROUP LLC

Order : 950949 Camden, NJ. ABC Barrel Project

P.O. :

Tkt. No. 1006028065

Product 114203

Bank Run

S.O. Info: Camden, NJ.

Ship Ref: 327 N. Front St



	Pounds	Kilo
Gross	79,380	36,006
Tare	28,700 *	13,018
Net	50,680	22,988

25.34 Ton 22.99

* Predetermined Tare

	UNIT	TOTALS
Material:		
Freight:		
Tax:		
Fee / Fuel:		
Other Chrg:	No	

Today Tons:	808.86	Loads:
Tons To Date:	12,600.02	32
Today Tonnes	733.79	
Tonnes To Date:	11,430.55	

By acceptance of this ticket (with or without signature), driver accepts on behalf of themselves/their employer sole responsibility to ensure that the load received is within the weight limit authorized by law and shall hold seller harmless against any and all claims with respect to same CURB DELIVERY ONLY. NOT RESPONSIBLE FOR ANY DAMAGE BEYOND CURB.

Carrier : 8040648 GJ SCOTT LLC

Vehicle: GS15 GS15

License: AS672T

MaxGVW: 80,000

Received: _____

Cust: _____

Weighmaster: Colleen LeSage

P/D Status: Deliver

Customer Copy

Scale: 1



Plant: 32411

Berlin

368 New Brooklyn Road
Berlin, NJ 08009
856-809-0142

3/28/2017 12:12

In :

Customer: 8638404 THE AMBIENT GROUP LLC

Order : 950949 Camden, NJ. ABC Barrel Project

P.O. :

Tkt. No. 1006028066

Product 114203



Bank Run

S.O. Info: Camden, NJ.

Ship Ref: 327 N. Front St

	Pounds	Kilo
Gross	79,280	35,961
Tare	27,300 *	12,383
Net	51,980	23,578

25.99 Ton 23.58

* Predetermined Tare

	UNIT	TOTALS
Material:		
Freight:		
Tax:		
Fee / Fuel:		
Other Chrg: No		

Today Tons:	834.85	Loads:
Tons To Date:	12,626.01	33
Today Tonnes	757.36	
Tonnes To Date:	11,454.12	

By acceptance of this ticket (with or without signature), driver accepts on behalf of themselves/their employer sole responsibility to ensure that the load received is within the weight limit authorized by law and shall hold seller harmless against any and all claims with respect to same CURB DELIVERY ONLY. NOT RESPONSIBLE FOR ANY DAMAGE BEYOND CURB.

Carrier : 8040648 GJ SCOTT LLC

Vehicle: GS11 GS11

License: AN120Z

MaxGVW: 80,000

Received: _____ Cust: _____

Weighmaster: Colleen LeSage

P/D Status: Deliver

Customer Do Not Accept [1] Scale: 1



Plant: 32411

Berlin

368 New Brooklyn Road
Berlin, NJ 08009
856-809-0142

3/28/2017 12:17

In :

Customer: 8638404 THE AMBIENT GROUP LLC

Order : 950949 Camden, NJ. ABC Barrel Project

P.O. :

Tkt. No. 1006028067

Product 114203



Bank Run

S.O. Info: Camden, NJ.

Ship Ref: 327 N. Front St

	Pounds	Kilo
Gross	75,060	34,047
Tare	25,080 *	11,376
Net	49,980	22,671

24.99 Ton 22.67

* Predetermined Tare

	UNIT	TOTALS
Material:		
Freight:		
Tax:		
Fee / Fuel:		
Other Chrg: No		

Today Tons:	859.84	Loads:
Tons To Date:	12,651.00	34
Today Tonnes	780.03	
Tonnes To Date:	11,476.79	

By acceptance of this ticket (with or without signature), driver accepts on behalf of themselves/their employer sole responsibility to ensure that the load received is within the weight limit authorized by law and shall hold seller harmless against any and all claims with respect to same CURB DELIVERY ONLY. NOT RESPONSIBLE FOR ANY DAMAGE BEYOND CURB.

Carrier : 8515471 CALLE TRUCKING LLC

Vehicle: CALLE12 Calle Trucking

License: AG43568

MaxGVW: 80,000

Received: _____ Cust: _____

Weighmaster: Colleen LeSage

P/D Status: Deliver

Customer Copy Scale: 1



Plant: 32411

Berlin

368 New Brooklyn Road
Berlin, NJ 08009
856-809-0142

3/28/2017 12:41

In :

Customer: 8638404 THE AMBIENT GROUP LLC

Order : 950949 Camden, NJ. ABC Barrel Project

P.O. :

Tkt. No. 1006028073

Product 114203

Bank Run

S.O. Info: Camden, NJ.

Ship Ref: 327 N. Front St



	Pounds	Kilo
Gross	78,360	35,543
Tare	28,100 *	12,746
Net	50,260	22,798

25.13 Ton 22.80

* Predetermined Tare

Today Tons:	884.97	Loads:
Tons To Date:	12,676.13	35
Today Tonnes	802.83	
Tonnes To Date:	11,499.59	

	UNIT	TOTALS
Material:		
Freight:		
Tax:		
Fee / Fuel:		
Other Chrg: No		

Carrier : 8040648 GJ SCOTT LLC

Vehicle: GS16 GS16

License: AT639K

MaxGVW: 80,000

Received: _____

Weighmaster: Colleen LeSage

Cust: _____

By acceptance of this ticket (with or without signature), driver accepts on behalf of themselves/their employer sole responsibility to ensure that the load received is within the weight limit authorized by law and shall hold seller harmless against any and all claims with respect to same CURB DELIVERY ONLY. NOT RESPONSIBLE FOR ANY DAMAGE BEYOND CURB.

P/D Status: Deliver

Customer Copy

Scale: 1



Plant: 32411

Berlin

368 New Brooklyn Road
Berlin, NJ 08009
856-809-0142

3/28/2017 12:43

In :

Customer: 8638404 THE AMBIENT GROUP LLC

Order : 950949 Camden, NJ. ABC Barrel Project

P.O. :

Tkt. No. 1006028074

Product 114203

Bank Run

S.O. Info: Camden, NJ.

Ship Ref: 327 N. Front St



	Pounds	Kilo
Gross	78,660	35,680
Tare	28,060 *	12,728
Net	50,600	22,952

25.30 Ton 22.95

* Predetermined Tare

Today Tons:	910.27	Loads:
Tons To Date:	12,701.43	36
Today Tonnes	825.78	
Tonnes To Date:	11,522.54	

	UNIT	TOTALS
Material:		
Freight:		
Tax:		
Fee / Fuel:		
Other Chrg: No		

Carrier : 8040648 GJ SCOTT LLC

Vehicle: GS4 GS4

License: AJ118L

MaxGVW: 80,000

Received: _____

Weighmaster: Colleen LeSage

Cust: _____

By acceptance of this ticket (with or without signature), driver accepts on behalf of themselves/their employer sole responsibility to ensure that the load received is within the weight limit authorized by law and shall hold seller harmless against any and all claims with respect to same CURB DELIVERY ONLY. NOT RESPONSIBLE FOR ANY DAMAGE BEYOND CURB.

P/D Status: Deliver

Customer Do Not Accept [1]

Scale: 1



Plant: 32411

Berlin

368 New Brooklyn Road
Berlin, NJ 08009
856-809-0142

3/28/2017 13:25

In :

Customer: 8638404 THE AMBIENT GROUP LLC

Order : 950949 Camden, NJ. ABC Barrel Project

P.O. :

Tkt. No. 1006028075

Product 114203

Bank Run

S.O. Info: Camden, NJ.

Ship Ref: 327 N. Front St



	Pounds	Kilo
Gross	79,700	36,151
Tare	28,700 *	13,018
Net	51,000	23,133

25.50 Ton 23.13

* Predetermined Tare

	UNIT	TOTALS
Material:		
Freight:		
Tax:		
Fee / Fuel:		
Other Chrg: No		

Today Tons:	935.77	Loads:
Tons To Date:	12,726.93	37
Today Tonnes	848.92	
Tonnes To Date:	11,545.68	

Carrier : 8040648 GJ SCOTT LLC

Vehicle: GS14 GS14

License: As672T

MaxGVW: 80,000

Received: _____

Cust: _____

Weighmaster: Colleen LeSage

P/D Status: Deliver

Customer Copy

Scale: 1

By acceptance of this ticket (with or without signature), driver accepts on behalf of themselves/their employer sole responsibility to ensure that the load received is within the weight limit authorized by law and shall hold seller harmless against any and all claims with respect to same CURB DELIVERY ONLY. NOT RESPONSIBLE FOR ANY DAMAGE BEYOND CURB.



Plant: 32411

Berlin

368 New Brooklyn Road
Berlin, NJ 08009
856-809-0142

3/28/2017 13:27

In :

Customer: 8638404 THE AMBIENT GROUP LLC

Order : 950949 Camden, NJ. ABC Barrel Project

P.O. :

Tkt. No. 1006028076

Product 114203

Bank Run

S.O. Info: Camden, NJ.

Ship Ref: 327 N. Front St



	Pounds	Kilo
Gross	78,160	35,453
Tare	27,380 *	12,419
Net	50,780	23,033

25.39 Ton 23.03

* Predetermined Tare

	UNIT	TOTALS
Material:		
Freight:		
Tax:		
Fee / Fuel:		
Other Chrg: No		

Today Tons:	961.16	Loads:
Tons To Date:	12,752.32	38
Today Tonnes	871.95	
Tonnes To Date:	11,568.71	

Carrier : 8040648 GJ SCOTT LLC

Vehicle: GS9 GS9

License: AK587X

MaxGVW: 80,000

Received: _____

Cust: _____

Weighmaster: Colleen LeSage

P/D Status: Deliver

Customer Copy

Scale: 1

By acceptance of this ticket (with or without signature), driver accepts on behalf of themselves/their employer sole responsibility to ensure that the load received is within the weight limit authorized by law and shall hold seller harmless against any and all claims with respect to same CURB DELIVERY ONLY. NOT RESPONSIBLE FOR ANY DAMAGE BEYOND CURB.



Plant: 32411

Berlin

368 New Brooklyn Road
Berlin, NJ 08009
856-809-0142

3/28/2017 13:30

In:

Customer: 8638404 THE AMBIENT GROUP LLC

Order: 950949 Camden, NJ. ABC Barrel Project

P.O.:

Tkt. No. 1006028077

Product 114203

Bank Run

S.O. Info: Camden, NJ.

Ship Ref: 327 N. Front St



	Pounds	Kilo
Gross	78,820	35,752
Tare	28,000 *	12,701
Net	50,820	23,052

25.41 Ton 23.05

* Predetermined Tare

	UNIT	TOTALS
Material:		
Freight:		
Tax:		
Fee / Fuel:		
Other Chrg: No		

Today Tons:	986.57	Loads:
Tons To Date:	12,777.73	39
Today Tonnes	895.00	
Tonnes To Date:	11,591.76	

By acceptance of this ticket (with or without signature), driver accepts on behalf of themselves/their employer sole responsibility to ensure that the load received is within the weight limit authorized by law and shall hold seller harmless against any and all claims with respect to same CURB DELIVERY ONLY. NOT RESPONSIBLE FOR ANY DAMAGE BEYOND CURB.

Carrier: 8040648 GJ SCOTT LLC

Vehicle: GS17 GS17

License: AT640K

MaxGVW: 80,000

Received:

Cust:

Weighmaster: Colleen LeSage

P/D Status: Deliver

Customer Copy

Scale: 1



Plant: 32411

Berlin

368 New Brooklyn Road
Berlin, NJ 08009
856-809-0142

3/28/2017 13:37

In:

Customer: 8638404 THE AMBIENT GROUP LLC

Order: 950949 Camden, NJ. ABC Barrel Project

P.O.:

Tkt. No. 1006028078

Product 114203

Bank Run

S.O. Info: Camden, NJ.

Ship Ref: 327 N. Front St



	Pounds	Kilo
Gross	77,160	34,999
Tare	23,080 *	10,469
Net	54,080	24,530

27.04 Ton 24.53

* Predetermined Tare

	UNIT	TOTALS
Material:		
Freight:		
Tax:		
Fee / Fuel:		
Other Chrg: No		

Today Tons:	1,013.61	Loads:
Tons To Date:	12,804.77	40
Today Tonnes	919.53	
Tonnes To Date:	11,616.29	

By acceptance of this ticket (with or without signature), driver accepts on behalf of themselves/their employer sole responsibility to ensure that the load received is within the weight limit authorized by law and shall hold seller harmless against any and all claims with respect to same CURB DELIVERY ONLY. NOT RESPONSIBLE FOR ANY DAMAGE BEYOND CURB.

Carrier: 9285292 BLUESTONE CONTRACTING C

Vehicle: SB11 XDUX86

License: XDUX86

MaxGVW: 80,000

Received:

Cust:

Weighmaster: Colleen LeSage

P/D Status: Deliver

Customer Copy

Scale: 1



Plant: 32411

Berlin

368 New Brooklyn Road
Berlin, NJ 08009
856-809-0142

3/28/2017 13:39

In :

Customer: 8638404 THE AMBIENT GROUP LLC

Order : 950949 Camden, NJ. ABC Barrel Project

P.O. :

Tkt. No. 1006028079

Product 114203
Bank Run
S.O. Info: Camden, NJ.
Ship Ref: 327 N. Front St



	Pounds	Kilo
Gross	79,540	36,079
Tare	28,700 *	13,018
Net	50,840	23,061

25.42 Ton 23.06

* Predetermined Tare

	UNIT	TOTALS
Material:		
Freight:		
Tax:		
Fee / Fuel:		
Other Chrg: No		

Today Tons:	1,039.03	Loads:
Tons To Date:	12,830.19	41
Today Tonnes	942.59	
Tonnes To Date:	11,639.35	

By acceptance of this ticket (with or without signature), driver accepts on behalf of themselves/their employer sole responsibility to ensure that the load received is within the weight limit authorized by law and shall hold seller harmless against any and all claims with respect to same CURB DELIVERY ONLY. NOT RESPONSIBLE FOR ANY DAMAGE BEYOND CURB.

Carrier : 8040648 GJ SCOTT LLC

Vehicle: GS15 GS15

License: AS672T

MaxGVW: 80,000

Received:

Weighmaster: Colleen LeSage

Cust: _____

P/D Status: Deliver

Customer Copy

Scale: 1



Plant: 32411

Berlin

368 New Brooklyn Road
Berlin, NJ 08009
856-809-0142

3/28/2017 13:46

In :

Customer: 8638404 THE AMBIENT GROUP LLC

Order : 950949 Camden, NJ. ABC Barrel Project

P.O. :

Tkt. No. 1006028080

Product 114203
Bank Run
S.O. Info: Camden, NJ.
Ship Ref: 327 N. Front St



	Pounds	Kilo
Gross	79,180	35,915
Tare	25,080 *	11,376
Net	54,100	24,539

27.05 Ton 24.54

* Predetermined Tare

	UNIT	TOTALS
Material:		
Freight:		
Tax:		
Fee / Fuel:		
Other Chrg: No		

Today Tons:	1,066.08	Loads:
Tons To Date:	12,857.24	42
Today Tonnes	967.13	
Tonnes To Date:	11,663.89	

By acceptance of this ticket (with or without signature), driver accepts on behalf of themselves/their employer sole responsibility to ensure that the load received is within the weight limit authorized by law and shall hold seller harmless against any and all claims with respect to same CURB DELIVERY ONLY. NOT RESPONSIBLE FOR ANY DAMAGE BEYOND CURB.

Carrier : 8515471 CALLE TRUCKING LLC

Vehicle: CALLE12 Calle Trucking

License: AG43568

MaxGVW: 80,000

Received: _____

Weighmaster: Colleen LeSage

Cust: _____

P/D Status: Deliver

Customer Do Not Accept [1]

Scale: 1



Plant: 32411

Berlin

368 New Brooklyn Road
Berlin, NJ 08009
856-809-0142

3/28/2017 13:48

In :

Customer: 8638404 THE AMBIENT GROUP LLC

Order : 950949 Camden, NJ. ABC Barrel Project

P.O. :

Tkt. No. 1006028081

Product 114203



Bank Run

S.O. Info: Camden, NJ.

Ship Ref: 327 N. Front St

	Pounds	Kilo
Gross	77,920	35,344
Tare	27,300 *	12,383
Net	50,620	22,961

25.31 Ton 22.96

* Predetermined Tare

UNIT	TOTALS
Material:	
Freight:	
Tax:	
Fee / Fuel:	
Other Chrg: <u>No</u>	

Today Tons:	1,091.39	Loads:
Tons To Date:	12,882.55	43
Today Tonnes	990.09	
Tonnes To Date:	11,686.85	

By acceptance of this ticket (with or without signature), driver accepts on behalf of themselves/their employer sole responsibility to ensure that the load received is within the weight limit authorized by law and shall hold seller harmless against any and all claims with respect to same
CURB DELIVERY ONLY. NOT RESPONSIBLE FOR ANY DAMAGE BEYOND CURB.

Carrier : 8040648 GJ SCOTT LLC

Vehicle: GS11 GS11

License: AN120Z

MaxGVW: 80,000

Received: _____

Cust: _____

Weighmaster: Colleen LeSage

P/D Status: Deliver

Customer Do Not Accept [1] Scale: 1



Plant: 32411

Berlin

368 New Brooklyn Road
Berlin, NJ 08009
856-809-0142

3/28/2017 13:59

In :

Customer: 8638404 THE AMBIENT GROUP LLC

Order : 950949 Camden, NJ. ABC Barrel Project

P.O. :

Tkt. No. 1006028082

Product 114203



Bank Run

S.O. Info: Camden, NJ.

Ship Ref: 327 N. Front St

	Pounds	Kilo
Gross	79,100	35,879
Tare	28,100 *	12,746
Net	51,000	23,133

25.50 Ton 23.13

* Predetermined Tare

UNIT	TOTALS
Material:	
Freight:	
Tax:	
Fee / Fuel:	
Other Chrg: <u>No</u>	

Today Tons:	1,116.89	Loads:
Tons To Date:	12,908.05	44
Today Tonnes	1,013.23	
Tonnes To Date:	11,709.99	

By acceptance of this ticket (with or without signature), driver accepts on behalf of themselves/their employer sole responsibility to ensure that the load received is within the weight limit authorized by law and shall hold seller harmless against any and all claims with respect to same
CURB DELIVERY ONLY. NOT RESPONSIBLE FOR ANY DAMAGE BEYOND CURB.

Carrier : 8040648 GJ SCOTT LLC

Vehicle: GS16 GS16

License: AT639K

MaxGVW: 80,000

Received: _____

Cust: _____

Weighmaster: Colleen LeSage

P/D Status: Deliver

Customer Copy Scale: 1



Plant: 32411

Berlin

368 New Brooklyn Road
Berlin, NJ 08009
856-809-0142

3/28/2017 14:02

In :

Customer: 8638404 THE AMBIENT GROUP LLC

Order : 950949 Camden, NJ. ABC Barrel Project

P.O. :

Tkt. No. 1006028083

Product 114203

Bank Run

S.O. Info: Camden, NJ.

Ship Ref: 327 N. Front St



	Pounds	Kilo
Gross	78,900	35,788
Tare	28,060 *	12,728
Net	50,840	23,061

25.42 Ton 23.06

* Predetermined Tare

	UNIT	TOTALS
Material:		
Freight:		
Tax:		
Fee / Fuel:		
Other Chrg: No		

Today Tons:	1,142.31	Loads:
Tons To Date:	12,933.47	45
Today Tonnes	1,036.29	
Tonnes To Date:	11,733.05	

Carrier : 8040648 GJ SCOTT LLC

Vehicle: GS4 GS4

License: AJ118L

MaxGVW: 80,000

Received: 

Cust: _____

Weighmaster: Colleen LeSage

P/D Status: Deliver

By acceptance of this ticket (with or without signature), driver accepts on behalf of themselves/their employer sole responsibility to ensure that the load received is within the weight limit authorized by law and shall hold seller harmless against any and all claims with respect to same
CURB DELIVERY ONLY. NOT RESPONSIBLE FOR ANY DAMAGE BEYOND CURB.

Customer Do Not Accept [1] Scale: 1



Plant: 32411

Berlin

368 New Brooklyn Road
Berlin, NJ 08009
856-809-0142

3/29/2017 07:12 In: 6:33:25
Customer: 8638404 THE AMBIENT GROUP LLC
Order : 950949 Camden, NJ. ABC Barrel Project
P.O. :

Tkt. No. 1006028088

Product 114203
Bank Run
S.O. Info: Camden, NJ.
Ship Ref: 327 N. Front St



	Pounds	Kilo
Gross	78,560	35,634
Tare	27,820	12,619
Net	50,740	23,015
	25.37 Ton	23.02

	UNIT	TOTALS
Material:		
Freight:		
Tax:		
Fee / Fuel:		
Other Chrg: No		

Today Tons:	25.37	Loads:
Tons To Date:	12,958.84	1
Today Tonnes	23.02	
Tonnes To Date:	11,756.06	

Carrier : 9249110 CLM CONTRACTING LLC
Vehicle: CLM6 CLM6
License: AT597T
MaxGVW: 80,000

By acceptance of this ticket (with or without signature), driver accepts on behalf of themselves/their employer sole responsibility to ensure that the load received is within the weight limit authorized by law and shall hold seller harmless against any and all claims with respect to same CURB DELIVERY ONLY. NOT RESPONSIBLE FOR ANY DAMAGE BEYOND CURB.

Received: _____
Weighmaster: Colleen LeSage
P/D Status: Deliver

Cust: _____

Customer Copy Scale: 1



Plant: 32411

Berlin

368 New Brooklyn Road
Berlin, NJ 08009
856-809-0142

3/29/2017 07:14 In: 6:34:07
Customer: 8638404 THE AMBIENT GROUP LLC
Order : 950949 Camden, NJ. ABC Barrel Project
P.O. :

Tkt. No. 1006028089

Product 114203
Bank Run
S.O. Info: Camden, NJ.
Ship Ref: 327 N. Front St



	Pounds	Kilo
Gross	78,620	35,661
Tare	28,540	12,946
Net	50,080	22,716
	25.04 Ton	22.72

	UNIT	TOTALS
Material:		
Freight:		
Tax:		
Fee / Fuel:		
Other Chrg: No		

Today Tons:	50.41	Loads:
Tons To Date:	12,983.88	2
Today Tonnes	45.73	
Tonnes To Date:	11,778.78	

Carrier : 8040648 GJ SCOTT LLC
Vehicle: GS11 GS11
License: AN120Z
MaxGVW: 80,000

By acceptance of this ticket (with or without signature), driver accepts on behalf of themselves/their employer sole responsibility to ensure that the load received is within the weight limit authorized by law and shall hold seller harmless against any and all claims with respect to same CURB DELIVERY ONLY. NOT RESPONSIBLE FOR ANY DAMAGE BEYOND CURB.

Received: _____
Weighmaster: Colleen LeSage
P/D Status: Deliver

Cust: _____

Customer Copy Scale: 1



Plant: 32411

Berlin

368 New Brooklyn Road
Berlin, NJ 08009
856-809-0142

3/29/2017 07:15

In: 6:34:28

Customer: 8638404 THE AMBIENT GROUP LLC

Order: 950949 Camden, NJ. ABC Barrel Project

P.O.:

Tkt. No. 1006028090

Product 114203

Bank Run

S.O. Info: Camden, NJ.

Ship Ref: 327 N. Front St



	Pounds	Kilo
Gross	78,540	35,625
Tare	28,360	12,864
Net	50,180	22,761

25.09 Ton 22.76

	UNIT	TOTALS
Material:		
Freight:		
Tax:		
Fee / Fuel:		
Other Chrg: No		

Today Tons:	75.50	Loads:	
Tons To Date:	13,008.97		3
Today Tonnes	68.49		
Tonnes To Date:	11,801.54		

By acceptance of this ticket (with or without signature), driver accepts on behalf of themselves/their employer sole responsibility to ensure that the load received is within the weight limit authorized by law and shall holdseller harmless against any and all claims with respect to same CURB DELIVERY ONLY. NOT RESPONSIBLE FOR ANY DAMAGE BEYOND CURB.

Carrier: 8040648 GJ SCOTT LLC

Vehicle: GS17 GS17

License: AT640K

MaxGVW: 80,000

Received:

Cust: _____

Weighmaster: Colleen LeSage

P/D Status: Deliver

Customer Copy Scale: 1



Plant: 32411

Berlin

368 New Brooklyn Road
Berlin, NJ 08009
856-809-0142

3/29/2017 07:18

In: 6:47:41

Customer: 8638404 THE AMBIENT GROUP LLC

Order: 950949 Camden, NJ. ABC Barrel Project

P.O.:

Tkt. No. 1006028091

Product 114203

Bank Run

S.O. Info: Camden, NJ.

Ship Ref: 327 N. Front St



	Pounds	Kilo
Gross	78,560	35,634
Tare	28,140	12,764
Net	50,420	22,870

25.21 Ton 22.87

	UNIT	TOTALS
Material:		
Freight:		
Tax:		
Fee / Fuel:		
Other Chrg: No		

Today Tons:	100.71	Loads:	
Tons To Date:	13,034.18		4
Today Tonnes	91.36		
Tonnes To Date:	11,824.41		

By acceptance of this ticket (with or without signature), driver accepts on behalf of themselves/their employer sole responsibility to ensure that the load received is within the weight limit authorized by law and shall holdseller harmless against any and all claims with respect to same CURB DELIVERY ONLY. NOT RESPONSIBLE FOR ANY DAMAGE BEYOND CURB.

Carrier: 8040648 GJ SCOTT LLC

Vehicle: GS16 GS16

License: AT639K

MaxGVW: 80,000

Received:

Cust: _____

Weighmaster: Colleen LeSage

P/D Status: Deliver

Customer Copy Scale: 1



Plant: 32411

Berlin

368 New Brooklyn Road
Berlin, NJ 08009
856-809-0142

3/29/2017 07:23

In: 6:50:35

Customer: 8638404 THE AMBIENT GROUP LLC

Order: 950949 Camden, NJ. ABC Barrel Project

P.O.:

Tkt. No. 1006028093

Product 114203

Bank Run

S.O. Info: Camden, NJ.

Ship Ref: 327 N. Front St



	Pounds	Kilo
Gross	76,540	34,718
Tare	23,420	10,623
Net	53,120	24,095

26.56 Ton 24.09

	UNIT	TOTALS
Material:		
Freight:		
Tax:		
Fee / Fuel:		
Other Chrg:	No	

Today Tons:	127.27	Loads:
Tons To Date:	13,060.74	5
Today Tonnes	115.46	
Tonnes To Date:	11,848.50	

Carrier: 9285292 BLUESTONE CONTRACTING C

Vehicle: SB11 XDUX86

License: XDUX86

MaxGVW: 80,000

Received:

Weighmaster: Colleen LeSage

By acceptance of this ticket (with or without signature), driver accepts on behalf of themselves/their employer sole responsibility to ensure that the load received is within the weight limit authorized by law and shall hold seller harmless against any and all claims with respect to same CURB DELIVERY ONLY. NOT RESPONSIBLE FOR ANY DAMAGE BEYOND CURB.

Cust: _____

P/D Status: Deliver

Customer Copy

Scale: 1



Plant: 32411

Berlin

368 New Brooklyn Road
Berlin, NJ 08009
856-809-0142

3/29/2017 07:27

In: 6:51:41

Customer: 8638404 THE AMBIENT GROUP LLC

Order: 950949 Camden, NJ. ABC Barrel Project

P.O.:

Tkt. No. 1006028095

Product 114203

Bank Run

S.O. Info: Camden, NJ.

Ship Ref: 327 N. Front St



	Pounds	Kilo
Gross	78,380	35,553
Tare	28,560	12,955
Net	49,820	22,598

24.91 Ton 22.60

	UNIT	TOTALS
Material:		
Freight:		
Tax:		
Fee / Fuel:		
Other Chrg:	No	

Today Tons:	152.18	Loads:
Tons To Date:	13,085.65	6
Today Tonnes	138.06	
Tonnes To Date:	11,871.10	

Carrier: 8040648 GJ SCOTT LLC

Vehicle: GS14 GS14

License: As672T

MaxGVW: 80,000

Received:

Weighmaster: Colleen LeSage

By acceptance of this ticket (with or without signature), driver accepts on behalf of themselves/their employer sole responsibility to ensure that the load received is within the weight limit authorized by law and shall hold seller harmless against any and all claims with respect to same CURB DELIVERY ONLY. NOT RESPONSIBLE FOR ANY DAMAGE BEYOND CURB.

Cust: _____

P/D Status: Deliver

Customer Copy

Scale: 1



Plant: 32411

Berlin

368 New Brooklyn Road
Berlin, NJ 08009
856-809-0142

3/29/2017 09:07

In :

Customer: 8638404 THE AMBIENT GROUP LLC

Order : 950949 Camden, NJ. ABC Barrel Project

P.O. :

Tkt. No. 1006028104

Product 114203

Bank Run

S.O. Info: Camden, NJ.

Ship Ref: 327 N. Front St



	Pounds	Kilo
Gross	78,460	35,589
Tare	28,360 *	12,864
Net	50,100	22,725

25.05 Ton 22.72

* Predetermined Tare

Today Tons:	177.23	Loads:
Tons To Date:	13,110.70	7
Today Tonnes	160.78	
Tonnes To Date:	11,893.83	

	UNIT	TOTALS
Material:		
Freight:		
Tax:		
Fee / Fuel:		
Other Chrg:	No	

Carrier : 8040648 GJ SCOTT LLC

Vehicle: GS17 GS17

License: AT640K

MaxGVW: 80,000

Received: _____

Weighmaster: Colleen LeSage

Cust: _____

P/D Status: Deliver

Customer Copy

Scale: 1

By acceptance of this ticket (with or without signature), driver accepts on behalf of themselves/their employer sole responsibility to ensure that the load received is within the weight limit authorized by law and shall hold seller harmless against any and all claims with respect to same CURB DELIVERY ONLY .NOT RESPONSIBLE FOR ANY DAMAGE BEYOND CURB.



Plant: 32411

Berlin

368 New Brooklyn Road
Berlin, NJ 08009
856-809-0142

3/29/2017 09:12

In :

Customer: 8638404 THE AMBIENT GROUP LLC

Order : 950949 Camden, NJ. ABC Barrel Project

P.O. :

Tkt. No. 1006028105

Product 114203

Bank Run

S.O. Info: Camden, NJ.

Ship Ref: 327 N. Front St



	Pounds	Kilo
Gross	78,580	35,643
Tare	28,140 *	12,764
Net	50,440	22,879

25.22 Ton 22.88

* Predetermined Tare

Today Tons:	202.45	Loads:
Tons To Date:	13,135.92	8
Today Tonnes	183.66	
Tonnes To Date:	11,916.71	

	UNIT	TOTALS
Material:		
Freight:		
Tax:		
Fee / Fuel:		
Other Chrg:	No	

Carrier : 8040648 GJ SCOTT LLC

Vehicle: GS16 GS16

License: AT639K

MaxGVW: 80,000

Received: _____

Weighmaster: Colleen LeSage

Cust: _____

P/D Status: Deliver

Customer Copy

Scale: 1

By acceptance of this ticket (with or without signature), driver accepts on behalf of themselves/their employer sole responsibility to ensure that the load received is within the weight limit authorized by law and shall hold seller harmless against any and all claims with respect to same CURB DELIVERY ONLY .NOT RESPONSIBLE FOR ANY DAMAGE BEYOND CURB.



Plant: 32411

Berlin

368 New Brooklyn Road
Berlin, NJ 08009
856-809-0142

3/29/2017 09:15

In:

Customer: 8638404 THE AMBIENT GROUP LLC

Order: 950949 Camden, NJ. ABC Barrel Project

P.O.:

Tkt. No. 1006028106

Product 114203

Bank Run

S.O. Info: Camden, NJ.

Ship Ref: 327 N. Front St



	Pounds	Kilo
Gross	79,580	36,097
Tare	28,540 *	12,946
Net	51,040	23,151

25.52 Ton 23.15

* Predetermined Tare

	UNIT	TOTALS
Material:		
Freight:		
Tax:		
Fee / Fuel:		
Other Chrg:	No	

Today Tons:	227.97	Loads:
Tons To Date:	13,161.44	9
Today Tonnes	206.81	
Tonnes To Date:	11,939.86	

By acceptance of this ticket (with or without signature), driver accepts on behalf of themselves/their employer sole responsibility to ensure that the load received is within the weight limit authorized by law and shall hold seller harmless against any and all claims with respect to same. CURB DELIVERY ONLY. NOT RESPONSIBLE FOR ANY DAMAGE BEYOND CURB.

Carrier: 8040648 GJ SCOTT LLC

Vehicle: GS11 GS11

License: AN120Z

MaxGVW: 80,000

Received:

Weighmaster: Colleen LeSage

Cust:

P/D Status: Deliver

Customer Copy

Scale: 1



Plant: 32411

Berlin

368 New Brooklyn Road
Berlin, NJ 08009
856-809-0142

3/29/2017 09:17

In:

Customer: 8638404 THE AMBIENT GROUP LLC

Order: 950949 Camden, NJ. ABC Barrel Project

P.O.:

Tkt. No. 1006028107

Product 114203

Bank Run

S.O. Info: Camden, NJ.

Ship Ref: 327 N. Front St



	Pounds	Kilo
Gross	76,340	34,627
Tare	23,420 *	10,623
Net	52,920	24,004

26.46 Ton 24.00

* Predetermined Tare

	UNIT	TOTALS
Material:		
Freight:		
Tax:		
Fee / Fuel:		
Other Chrg:	No	

Today Tons:	254.43	Loads:
Tons To Date:	13,187.90	10
Today Tonnes	230.81	
Tonnes To Date:	11,963.86	

By acceptance of this ticket (with or without signature), driver accepts on behalf of themselves/their employer sole responsibility to ensure that the load received is within the weight limit authorized by law and shall hold seller harmless against any and all claims with respect to same. CURB DELIVERY ONLY. NOT RESPONSIBLE FOR ANY DAMAGE BEYOND CURB.

Carrier: 9285292 BLUESTONE CONTRACTING C

Vehicle: SB11 XDUX86

License: XDUX86

MaxGVW: 80,000

Received:

Weighmaster: Colleen LeSage

Cust:

P/D Status: Deliver

Customer Copy

Scale: 1



Plant: 32411

Berlin

368 New Brooklyn Road
Berlin, NJ 08009
856-809-0142

3/29/2017 09:22

In :

Customer: 8638404 THE AMBIENT GROUP LLC

Order : 950949 Camden, NJ. ABC Barrel Project

P.O. :

Tkt. No. 1006028108

Product 114203



Bank Run

S.O. Info: Camden, NJ.

Ship Ref: 327 N. Front St

	Pounds	Kilo
Gross	78,140	35,444
Tare	27,820 *	12,619
Net	50,320	22,825

25.16 Ton 22.82

* Predetermined Tare

	UNIT	TOTALS
Material:		
Freight:		
Tax:		
Fee / Fuel:		
Other Chrg: No		

Today Tons:	279.59	Loads:
Tons To Date:	13,213.06	11
Today Tonnes	253.64	
Tonnes To Date:	11,986.69	

Carrier : 9249110 CLM CONTRACTING LLC

Vehicle: CLM6 CLM6

License: AT597T

MaxGVW: 80,000

Received:

Weighmaster: Colleen LeSage

Cust:

P/D Status: Deliver

By acceptance of this ticket (with or without signature), driver accepts on behalf of themselves/their employer sole responsibility to ensure that the load received is within the weight limit authorized by law and shall hold seller harmless against any and all claims with respect to same CURB DELIVERY ONLY. NOT RESPONSIBLE FOR ANY DAMAGE BEYOND CURB.

Customer Do Not Accept [1] Scale: 1



Plant: 32411

Berlin

368 New Brooklyn Road
Berlin, NJ 08009
856-809-0142

3/29/2017 09:24

In :

Customer: 8638404 THE AMBIENT GROUP LLC

Order : 950949 Camden, NJ. ABC Barrel Project

P.O. :

Tkt. No. 1006028109

Product 114203



Bank Run

S.O. Info: Camden, NJ.

Ship Ref: 327 N. Front St

	Pounds	Kilo
Gross	79,300	35,970
Tare	28,560 *	12,955
Net	50,740	23,015

25.37 Ton 23.02

* Predetermined Tare

	UNIT	TOTALS
Material:		
Freight:		
Tax:		
Fee / Fuel:		
Other Chrg: No		

Today Tons:	304.96	Loads:
Tons To Date:	13,238.43	12
Today Tonnes	276.66	
Tonnes To Date:	12,009.70	

Carrier : 8040648 GJ SCOTT LLC

Vehicle: GS14 GS14

License: As672T

MaxGVW: 80,000

Received:

Weighmaster: Colleen LeSage

Cust:

P/D Status: Deliver

By acceptance of this ticket (with or without signature), driver accepts on behalf of themselves/their employer sole responsibility to ensure that the load received is within the weight limit authorized by law and shall hold seller harmless against any and all claims with respect to same CURB DELIVERY ONLY. NOT RESPONSIBLE FOR ANY DAMAGE BEYOND CURB.

Customer Copy Scale: 1



Plant: 32411

Berlin

368 New Brooklyn Road
Berlin, NJ 08009
856-809-0142

3/29/2017 10:34 In :
Customer: 8638404 THE AMBIENT GROUP LLC
Order : 950949 Camden, NJ. ABC Barrel Project
P.O. :

Tkt. No. 1006028113



Product 114203
Bank Run
S.O. Info: Camden, NJ.
Ship Ref: 327 N. Front St

	Pounds	Kilo
Gross	78,260	35,498
Tare	28,360 *	12,864
Net	49,900	22,634

24.95 Ton 22.63

* Predetermined Tare

	UNIT	TOTALS
Material:		
Freight:		
Tax:		
Fee / Fuel:		
Other Chrg: No		

Today Tons:	329.91	Loads:
Tons To Date:	13,263.38	13
Today Tonnes	299.29	
Tonnes To Date:	12,032.34	

By acceptance of this ticket (with or without signature), driver accepts on behalf of themselves/their employer sole responsibility to ensure that the load received is within the weight limit authorized by law and shall hold seller harmless against any and all claims with respect to same CURB DELIVERY ONLY. NOT RESPONSIBLE FOR ANY DAMAGE BEYOND CURB.

Carrier : 8040648 GJ SCOTT LLC

Vehicle: GS17 GS17

License: AT640K

MaxGVW: 80,000

Received: _____

Cust: _____

Weighmaster: Colleen LeSage

P/D Status: Deliver

Customer Copy

Scale: 1



Plant: 32411

Berlin

368 New Brooklyn Road
Berlin, NJ 08009
856-809-0142

3/29/2017 10:46 In :
Customer: 8638404 THE AMBIENT GROUP LLC
Order : 950949 Camden, NJ. ABC Barrel Project
P.O. :

Tkt. No. 1006028114



Product 114203
Bank Run
S.O. Info: Camden, NJ.
Ship Ref: 327 N. Front St

	Pounds	Kilo
Gross	78,620	35,661
Tare	28,540 *	12,946
Net	50,080	22,716

25.04 Ton 22.72

* Predetermined Tare

	UNIT	TOTALS
Material:		
Freight:		
Tax:		
Fee / Fuel:		
Other Chrg: No		

Today Tons:	354.95	Loads:
Tons To Date:	13,288.42	14
Today Tonnes	322.01	
Tonnes To Date:	12,055.05	

By acceptance of this ticket (with or without signature), driver accepts on behalf of themselves/their employer sole responsibility to ensure that the load received is within the weight limit authorized by law and shall hold seller harmless against any and all claims with respect to same CURB DELIVERY ONLY. NOT RESPONSIBLE FOR ANY DAMAGE BEYOND CURB.

Carrier : 8040648 GJ SCOTT LLC

Vehicle: GS11 GS11

License: AN120Z

MaxGVW: 80,000

Received: _____

Cust: _____

Weighmaster: Colleen LeSage

P/D Status: Deliver

Customer Copy

Scale: 1



Plant: 32411

Berlin

368 New Brooklyn Road
Berlin, NJ 08009
856-809-0142

3/29/2017 10:47 In :
Customer: 8638404 THE AMBIENT GROUP LLC
Order : 950949 Camden, NJ. ABC Barrel Project
P.O. :

Tkt. No. 1006028115



Product 114203
Bank Run
S.O. Info: Camden, NJ.
Ship Ref: 327 N. Front St

	Pounds	Kilo
Gross	78,960	35,816
Tare	28,140 *	12,764
Net	50,820	23,052

25.41 Ton 23.05

* Predetermined Tare

	UNIT	TOTALS
Material:		
Freight:		
Tax:		
Fee / Fuel:		
Other Chrg: No		

Today Tons:	380.36	Loads:
Tons To Date:	13,313.83	15
Today Tonnes	345.06	
Tonnes To Date:	12,078.10	

Carrier : 8040648 GJ SCOTT LLC
Vehicle: GS16 GS16
License: AT639K
MaxGVW: 80,000

By acceptance of this ticket (with or without signature), driver accepts on behalf of themselves/their employer sole responsibility to ensure that the load received is within the weight limit authorized by law and shall hold seller harmless against any and all claims with respect to same CURB DELIVERY ONLY. NOT RESPONSIBLE FOR ANY DAMAGE BEYOND CURB.

Received: 
Weighmaster: Colleen LeSage

Cust: _____

P/D Status: Deliver

Customer Copy

Scale: 1



Plant: 32411

Berlin

368 New Brooklyn Road
Berlin, NJ 08009
856-809-0142

3/29/2017 10:54 In :
Customer: 8638404 THE AMBIENT GROUP LLC
Order : 950949 Camden, NJ. ABC Barrel Project
P.O. :

Tkt. No. 1006028116



Product 114203
Bank Run
S.O. Info: Camden, NJ.
Ship Ref: 327 N. Front St

	Pounds	Kilo
Gross	78,800	35,743
Tare	28,560 *	12,955
Net	50,240	22,788

25.12 Ton 22.79

* Predetermined Tare

	UNIT	TOTALS
Material:		
Freight:		
Tax:		
Fee / Fuel:		
Other Chrg: No		

Today Tons:	405.48	Loads:
Tons To Date:	13,338.95	16
Today Tonnes	367.85	
Tonnes To Date:	12,100.89	

Carrier : 8040648 GJ SCOTT LLC
Vehicle: GS14 GS14
License: As672T
MaxGVW: 80,000

By acceptance of this ticket (with or without signature), driver accepts on behalf of themselves/their employer sole responsibility to ensure that the load received is within the weight limit authorized by law and shall hold seller harmless against any and all claims with respect to same CURB DELIVERY ONLY. NOT RESPONSIBLE FOR ANY DAMAGE BEYOND CURB.

Received: _____
Weighmaster: Colleen LeSage

Cust: _____

P/D Status: Deliver

Customer Copy

Scale: 1



Plant: 32411

Berlin

368 New Brooklyn Road
Berlin, NJ 08009
856-809-0142

3/29/2017 10:57 In :
Customer: 8638404 THE AMBIENT GROUP LLC
Order : 950949 Camden, NJ. ABC Barrel Project
P.O. :

Tkt. No. 1006028117

Product 114203
Bank Run
S.O. Info: Camden, NJ.
Ship Ref: 327 N. Front St



	Pounds	Kilo
Gross	77,400	35,108
Tare	23,420 *	10,623
Net	53,980	24,485

26.99 Ton 24.48
* Predetermined Tare

	UNIT	TOTALS
Material:		
Freight:		
Tax:		
Fee / Fuel:		
Other Chrg: No		

Today Tons:	432.47	Loads:
Tons To Date:	13,365.94	17
Today Tonnes	392.33	
Tonnes To Date:	12,125.38	

Carrier : 9285292 BLUESTONE CONTRACTING C
Vehicle: SB11 XDUX86
License: XDUX86
MaxGVW: 80,000

By acceptance of this ticket (with or without signature), driver accepts on behalf of themselves/their employer sole responsibility to ensure that the load received is within the weight limit authorized by law and shall hold seller harmless against any and all claims with respect to same CURB DELIVERY ONLY. NOT RESPONSIBLE FOR ANY DAMAGE BEYOND CURB.

Received: _____ Cust: _____
Weighmaster: Colleen LeSage

P/D Status: Deliver

Customer Copy

Scale: 1



Plant: 32411

Berlin

368 New Brooklyn Road
Berlin, NJ 08009
856-809-0142

3/29/2017 11:00 In :
Customer: 8638404 THE AMBIENT GROUP LLC
Order : 950949 Camden, NJ. ABC Barrel Project
P.O. :

Tkt. No. 1006028118

Product 114203
Bank Run
S.O. Info: Camden, NJ.
Ship Ref: 327 N. Front St



	Pounds	Kilo
Gross	78,800	35,743
Tare	27,820 *	12,619
Net	50,980	23,124

25.49 Ton 23.12
* Predetermined Tare

	UNIT	TOTALS
Material:		
Freight:		
Tax:		
Fee / Fuel:		
Other Chrg: No		

Today Tons:	457.96	Loads:
Tons To Date:	13,391.43	18
Today Tonnes	415.45	
Tonnes To Date:	12,148.50	

Carrier : 9249110 CLM CONTRACTING LLC
Vehicle: CLM6 CLM6
License: AT597T
MaxGVW: 80,000

By acceptance of this ticket (with or without signature), driver accepts on behalf of themselves/their employer sole responsibility to ensure that the load received is within the weight limit authorized by law and shall hold seller harmless against any and all claims with respect to same CURB DELIVERY ONLY. NOT RESPONSIBLE FOR ANY DAMAGE BEYOND CURB.

Received: _____ Cust: _____
Weighmaster: Colleen LeSage

P/D Status: Deliver

Customer Do Not Accept [1]

Scale: 1



Plant: 32411

Berlin

368 New Brooklyn Road
Berlin, NJ 08009
856-809-0142

3/29/2017 12:12 In :
Customer: 8638404 THE AMBIENT GROUP LLC
Order : 950949 Camden, NJ. ABC Barrel Project
P.O. :

Tkt. No. 1006028125



Product 114203
Bank Run
S.O. Info: Camden, NJ.
Ship Ref: 327 N. Front St

	Pounds	Kilo
Gross	77,660	35,226
Tare	28,360 *	12,864
Net	49,300	22,362

24.65 Ton 22.36

* Predetermined Tare

	UNIT	TOTALS
Material:		
Freight:		
Tax:		
Fee / Fuel:		
Other Chrg:	No	

Today Tons:	482.61	Loads:
Tons To Date:	13,416.08	19
Today Tonnes	437.82	
Tonnes To Date:	12,170.86	

Carrier : 8040648 GJ SCOTT LLC
Vehicle: GS17 GS17
License: AT640K
MaxGVW: 80,000

By acceptance of this ticket (with or without signature), driver accepts on behalf of themselves/their employer sole responsibility to ensure that the load received is within the weight limit authorized by law and shall hold seller harmless against any and all claims with respect to same CURB DELIVERY ONLY. NOT RESPONSIBLE FOR ANY DAMAGE BEYOND CURB.

Received: _____
Weighmaster: Colleen LeSage

Cust: _____

P/D Status: Deliver

Customer Copy

Scale: 1



Plant: 32411

Berlin

368 New Brooklyn Road
Berlin, NJ 08009
856-809-0142

3/29/2017 12:13 In :
Customer: 8638404 THE AMBIENT GROUP LLC
Order : 950949 Camden, NJ. ABC Barrel Project
P.O. :

Tkt. No. 1006028126



Product 114203
Bank Run
S.O. Info: Camden, NJ.
Ship Ref: 327 N. Front St

	Pounds	Kilo
Gross	79,360	35,997
Tare	28,540 *	12,946
Net	50,820	23,052

25.41 Ton 23.05

* Predetermined Tare

	UNIT	TOTALS
Material:		
Freight:		
Tax:		
Fee / Fuel:		
Other Chrg:	No	

Today Tons:	508.02	Loads:
Tons To Date:	13,441.49	20
Today Tonnes	460.87	
Tonnes To Date:	12,193.91	

Carrier : 8040648 GJ SCOTT LLC
Vehicle: GS11 GS11
License: AN120Z
MaxGVW: 80,000

By acceptance of this ticket (with or without signature), driver accepts on behalf of themselves/their employer sole responsibility to ensure that the load received is within the weight limit authorized by law and shall hold seller harmless against any and all claims with respect to same CURB DELIVERY ONLY. NOT RESPONSIBLE FOR ANY DAMAGE BEYOND CURB.

Received: _____
Weighmaster: Colleen LeSage

Cust: _____

P/D Status: Deliver

Customer Copy

Scale: 1



Plant: 32411

Berlin

368 New Brooklyn Road
Berlin, NJ 08009
856-809-0142

3/29/2017 12:13

In:

Customer: 8638404 THE AMBIENT GROUP LLC

Order: 950949 Camden, NJ. ABC Barrel Project

P.O.:

Tkt. No. 1006028127

Product 114203

Bank Run

S.O. Info: Camden, NJ.

Ship Ref: 327 N. Front St



	Pounds	Kilo
Gross	78,420	35,571
Tare	28,140 *	12,764
Net	50,280	22,807

25.14 Ton 22.81

* Predetermined Tare

Today Tons:	533.16	Loads:
Tons To Date:	13,466.63	21
Today Tonnes	483.67	
Tonnes To Date:	12,216.72	

	UNIT	TOTALS
Material:		
Freight:		
Tax:		
Fee / Fuel:		
Other Chrg:	No	

Carrier: 8040648 GJ SCOTT LLC

Vehicle: GS16 GS16

License: AT639K

MaxGVW: 80,000

Received:

Weighmaster: Colleen LeSage

Cust:

P/D Status: Deliver

By acceptance of this ticket (with or without signature), driver accepts on behalf of themselves/their employer sole responsibility to ensure that the load received is within the weight limit authorized by law and shall hold seller harmless against any and all claims with respect to same CURB DELIVERY ONLY. NOT RESPONSIBLE FOR ANY DAMAGE BEYOND CURB.

Customer Copy

Scale: 1



Plant: 32411

Berlin

368 New Brooklyn Road
Berlin, NJ 08009
856-809-0142

3/29/2017 12:17

In:

Customer: 8638404 THE AMBIENT GROUP LLC

Order: 950949 Camden, NJ. ABC Barrel Project

P.O.:

Tkt. No. 1006028128

Product 114203

Bank Run

S.O. Info: Camden, NJ.

Ship Ref: 327 N. Front St



	Pounds	Kilo
Gross	78,480	35,598
Tare	28,560 *	12,955
Net	49,920	22,643

24.96 Ton 22.64

* Predetermined Tare

Today Tons:	558.12	Loads:
Tons To Date:	13,491.59	22
Today Tonnes	506.32	
Tonnes To Date:	12,239.36	

	UNIT	TOTALS
Material:		
Freight:		
Tax:		
Fee / Fuel:		
Other Chrg:	No	

Carrier: 8040648 GJ SCOTT LLC

Vehicle: GS14 GS14

License: As672T

MaxGVW: 80,000

Received:

Weighmaster: Colleen LeSage

Cust:

P/D Status: Deliver

By acceptance of this ticket (with or without signature), driver accepts on behalf of themselves/their employer sole responsibility to ensure that the load received is within the weight limit authorized by law and shall hold seller harmless against any and all claims with respect to same CURB DELIVERY ONLY. NOT RESPONSIBLE FOR ANY DAMAGE BEYOND CURB.

Customer Copy

Scale: 1



Plant: 32411

Berlin

368 New Brooklyn Road
Berlin, NJ 08009
856-809-0142

3/29/2017 12:37

In :

Customer: 8638404 THE AMBIENT GROUP LLC

Order : 950949 Camden, NJ. ABC Barrel Project

P.O. :

Tkt. No. 1006028131

Product 114203

Bank Run

S.O. Info: Camden, NJ.

Ship Ref: 327 N. Front St



	Pounds	Kilo
Gross	78,620	35,661
Tare	27,820 *	12,619
Net	50,800	23,042

25.40 Ton 23.04

* Predetermined Tare

Today Tons:	583.52	Loads:
Tons To Date:	13,516.99	23
Today Tonnes	529.36	
Tonnes To Date:	12,262.41	

	UNIT	TOTALS
Material:		
Freight:		
Tax:		
Fee / Fuel:		
Other Chrg: No		

Carrier : 9249110 CLM CONTRACTING LLC

Vehicle: CLM6 CLM6

License: AT597T

MaxGVW: 80,000

Received:

Weighmaster: Colleen LeSage

P/D Status: Deliver

Cust: _____

By acceptance of this ticket (with or without signature), driver accepts on behalf of themselves/their employer sole responsibility to ensure that the load received is within the weight limit authorized by law and shall hold seller harmless against any and all claims with respect to same CURB DELIVERY ONLY. NOT RESPONSIBLE FOR ANY DAMAGE BEYOND CURB.

Customer Do Not Accept [1] Scale: 1



Plant: 32411

Berlin

368 New Brooklyn Road
Berlin, NJ 08009
856-809-0142

3/29/2017 12:40

In :

Customer: 8638404 THE AMBIENT GROUP LLC

Order : 950949 Camden, NJ. ABC Barrel Project

P.O. :

Tkt. No. 1006028132

Product 114203

Bank Run

S.O. Info: Camden, NJ.

Ship Ref: 327 N. Front St



	Pounds	Kilo
Gross	76,920	34,890
Tare	23,420 *	10,623
Net	53,500	24,267

26.75 Ton 24.27

* Predetermined Tare

Today Tons:	610.27	Loads:
Tons To Date:	13,543.74	24
Today Tonnes	553.63	
Tonnes To Date:	12,286.67	

	UNIT	TOTALS
Material:		
Freight:		
Tax:		
Fee / Fuel:		
Other Chrg: No		

Carrier : 9285292 BLUESTONE CONTRACTING C

Vehicle: SB11 XDUX86

License: XDUX86

MaxGVW: 80,000

Received:

Weighmaster: Colleen LeSage

P/D Status: Deliver

Cust: _____

By acceptance of this ticket (with or without signature), driver accepts on behalf of themselves/their employer sole responsibility to ensure that the load received is within the weight limit authorized by law and shall hold seller harmless against any and all claims with respect to same CURB DELIVERY ONLY. NOT RESPONSIBLE FOR ANY DAMAGE BEYOND CURB.

Customer Copy Scale: 1



Plant: 32411

Berlin

368 New Brooklyn Road
Berlin, NJ 08009
856-809-0142

3/29/2017 13:34 In :
Customer: 8638404 THE AMBIENT GROUP LLC
Order : 950949 Camden, NJ. ABC Barrel Project
P.O. :

Tkt. No. 1006028135



Product 114203
Bank Run
S.O. Info: Camden, NJ.
Ship Ref: 327 N. Front St

	Pounds	Kilo
Gross	78,820	35,752
Tare	28,360 *	12,864
Net	50,460	22,888

25.23 Ton 22.89

* Predetermined Tare

	UNIT	TOTALS
Material:		
Freight:		
Tax:		
Fee / Fuel:		
Other Chrg: No		

Today Tons:	635.50	Loads:
Tons To Date:	13,568.97	25
Today Tonnes	576.52	
Tonnes To Date:	12,309.56	

By acceptance of this ticket (with or without signature), driver accepts on behalf of themselves/their employer sole responsibility to ensure that the load received is within the weight limit authorized by law and shall hold seller harmless against any and all claims with respect to same CURB DELIVERY ONLY. NOT RESPONSIBLE FOR ANY DAMAGE BEYOND CURB.

Carrier : 8040648 GJ SCOTT LLC
Vehicle: GS17 GS17
License: AT640K
MaxGVW: 80,000

Received: _____
Weighmaster: Colleen LeSage

Cust: _____

P/D Status: Deliver

Customer Copy

Scale: 1



Plant: 32411

Berlin

368 New Brooklyn Road
Berlin, NJ 08009
856-809-0142

3/29/2017 13:36 In :
Customer: 8638404 THE AMBIENT GROUP LLC
Order : 950949 Camden, NJ. ABC Barrel Project
P.O. :

Tkt. No. 1006028136



Product 114203
Bank Run
S.O. Info: Camden, NJ.
Ship Ref: 327 N. Front St

	Pounds	Kilo
Gross	78,660	35,680
Tare	28,140 *	12,764
Net	50,520	22,915

25.26 Ton 22.92

* Predetermined Tare

	UNIT	TOTALS
Material:		
Freight:		
Tax:		
Fee / Fuel:		
Other Chrg: No		

Today Tons:	660.76	Loads:
Tons To Date:	13,594.23	26
Today Tonnes	599.43	
Tonnes To Date:	12,332.48	

By acceptance of this ticket (with or without signature), driver accepts on behalf of themselves/their employer sole responsibility to ensure that the load received is within the weight limit authorized by law and shall hold seller harmless against any and all claims with respect to same CURB DELIVERY ONLY. NOT RESPONSIBLE FOR ANY DAMAGE BEYOND CURB.

Carrier : 8040648 GJ SCOTT LLC
Vehicle: GS16 GS16
License: AT639K
MaxGVW: 80,000

Received: _____
Weighmaster: Colleen LeSage

Cust: _____

P/D Status: Deliver

Customer Copy

Scale: 1



Plant: 32411

Berlin

368 New Brooklyn Road
Berlin, NJ 08009
856-809-0142

3/29/2017 13:43 In :
Customer: 8638404 THE AMBIENT GROUP LLC
Order : 950949 Camden, NJ. ABC Barrel Project
P.O. :

Tkt. No. 1006028138



Product 114203
Bank Run
S.O. Info: Camden, NJ.
Ship Ref: 327 N. Front St

	Pounds	Kilo
Gross	79,040	35,852
Tare	28,540 *	12,946
Net	50,500	22,906

25.25 Ton 22.91
* Predetermined Tare

	UNIT	TOTALS
Material:		
Freight:		
Tax:		
Fee / Fuel:		
Other Chrg: No		

Today Tons:	686.01	Loads:
Tons To Date:	13,619.48	27
Today Tonnes	622.34	
Tonnes To Date:	12,355.38	

Carrier : 8040648 GJ SCOTT LLC
Vehicle: GS11 GS11
License: AN120Z
MaxGVW: 80,000

By acceptance of this ticket (with or without signature), driver accepts on behalf of themselves/their employer sole responsibility to ensure that the load received is within the weight limit authorized by law and shall hold seller harmless against any and all claims with respect to same CURB DELIVERY ONLY. NOT RESPONSIBLE FOR ANY DAMAGE BEYOND CURB.

Received: _____
Weighmaster: Colleen LeSage

Cust: _____

P/D Status: Deliver

Customer Copy

Scale: 1



Plant: 32411

Berlin

368 New Brooklyn Road
Berlin, NJ 08009
856-809-0142

3/29/2017 13:48 In :
Customer: 8638404 THE AMBIENT GROUP LLC
Order : 950949 Camden, NJ. ABC Barrel Project
P.O. :

Tkt. No. 1006028140



Product 114203
Bank Run
S.O. Info: Camden, NJ.
Ship Ref: 327 N. Front St

	Pounds	Kilo
Gross	78,620	35,661
Tare	28,560 *	12,955
Net	50,060	22,707

25.03 Ton 22.71
* Predetermined Tare

	UNIT	TOTALS
Material:		
Freight:		
Tax:		
Fee / Fuel:		
Other Chrg: No		

Today Tons:	711.04	Loads:
Tons To Date:	13,644.51	28
Today Tonnes	645.04	
Tonnes To Date:	12,378.09	

Carrier : 8040648 GJ SCOTT LLC
Vehicle: GS14 GS14
License: As672T
MaxGVW: 80,000

By acceptance of this ticket (with or without signature), driver accepts on behalf of themselves/their employer sole responsibility to ensure that the load received is within the weight limit authorized by law and shall hold seller harmless against any and all claims with respect to same CURB DELIVERY ONLY. NOT RESPONSIBLE FOR ANY DAMAGE BEYOND CURB.

Received: _____
Weighmaster: Colleen LeSage

Cust: _____

P/D Status: Deliver

Customer Do Not Accept [1]

Scale: 1



Plant: 32411

Berlin

368 New Brooklyn Road
Berlin, NJ 08009
856-809-0142

3/29/2017 14:11

In: 14:11:26

Customer: 8638404

THE AMBIENT GROUP LLC

Order: 950949

Camden, NJ. ABC Barrel Project

Tkt. No. 1006028143

P.O.:



Product 114203

Bank Run

S.O. Info: Camden, NJ.

Ship Ref: 327 N. Front St

	Pounds	Kilo
Gross	78,160	35,453
Tare	27,820 *	12,619
Net	50,340	22,834

25.17 Ton 22.83

* Predetermined Tare

	UNIT	TOTALS
Material:		
Freight:		
Tax:		
Fee / Fuel:		
Other Chrg: No		

Today Tons:	736.21	Loads:
Tons To Date:	13,669.68	29
Today Tonnes	667.88	
Tonnes To Date:	12,400.93	

Carrier: 9249110 CLM CONTRACTING LLC

Vehicle: CLM6

CLM6

License: AT597T

MaxGVW: 80,000

Received:

Weighmaster: Colleen LeSage

P/D Status: Deliver

By acceptance of this ticket (with or without signature), driver accepts on behalf of themselves/their employer sole responsibility to ensure that the load received is within the weight limit authorized by law and shall hold seller harmless against any and all claims with respect to same
CURB DELIVERY ONLY. NOT RESPONSIBLE FOR ANY DAMAGE BEYOND CURB.

Cust: _____

Customer Do Not Accept Scale: 1



Plant: 32411

Berlin

368 New Brooklyn Road
Berlin, NJ 08009
856-809-0142

3/30/2017 07:19

In: 6:34:46

Customer: 8638404 THE AMBIENT GROUP LLC

Order: 950949 Camden, NJ. ABC Barrel Project

P.O.:

Tkt. No. 1006028152

Product 114203

Bank Run

S.O. Info: Camden, NJ.

Ship Ref: 327 N. Front St



	Pounds	Kilo
Gross	77,960	35,362
Tare	24,820	11,258
Net	53,140	24,104

26.57 Ton 24.10

Material:	UNIT	TOTALS
Freight:		
Tax:		
Fee / Fuel:		
Other Chrg: No		

Today Tons:	26.57	Loads:
Tons To Date:	13,696.25	1
Today Tonnes	24.10	
Tonnes To Date:	12,425.03	

By acceptance of this ticket (with or without signature), driver accepts on behalf of themselves/their employer sole responsibility to ensure that the load received is within the weight limit authorized by law and shall hold seller harmless against any and all claims with respect to same CURB DELIVERY ONLY. NOT RESPONSIBLE FOR ANY DAMAGE BEYOND CURB.

Carrier: 907040 EAZY TRUCKING LLC

Vehicle: EAZY1 AS757R

License: AS757R

MaxGVW: 80,000

Received:

Weighmaster: Colleen LeSage

Cust: _____

P/D Status: Deliver

Customer Copy

Scale: 1



Plant: 32411

Berlin

368 New Brooklyn Road
Berlin, NJ 08009
856-809-0142

3/30/2017 07:21

In: 6:37:13

Customer: 8638404 THE AMBIENT GROUP LLC

Order: 950949 Camden, NJ. ABC Barrel Project

P.O.:

Tkt. No. 1006028153

Product 114203

Bank Run

S.O. Info: Camden, NJ.

Ship Ref: 327 N. Front St



	Pounds	Kilo
Gross	78,620	35,661
Tare	28,020	12,710
Net	50,600	22,952

25.30 Ton 22.95

Material:	UNIT	TOTALS
Freight:		
Tax:		
Fee / Fuel:		
Other Chrg: No		

Today Tons:	51.87	Loads:
Tons To Date:	13,721.55	2
Today Tonnes	47.06	
Tonnes To Date:	12,447.98	

By acceptance of this ticket (with or without signature), driver accepts on behalf of themselves/their employer sole responsibility to ensure that the load received is within the weight limit authorized by law and shall hold seller harmless against any and all claims with respect to same CURB DELIVERY ONLY. NOT RESPONSIBLE FOR ANY DAMAGE BEYOND CURB.

Carrier: 8040648 GJ SCOTT LLC

Vehicle: GS17 GS17

License: AT640K

MaxGVW: 80,000

Received:

Weighmaster: Colleen LeSage

Cust: _____

P/D Status: Deliver

Customer Do Not Accept [1]

Scale: 1



Plant: 32411

Berlin

368 New Brooklyn Road
Berlin, NJ 08009
856-809-0142

3/30/2017 07:22 In: 6:37:41
Customer: 8638404 THE AMBIENT GROUP LLC
Order: 950949 Camden, NJ. ABC Barrel Project
P.O.:

Tkt. No. 1006028154



Product 114203
Bank Run
S.O. Info: Camden, NJ.
Ship Ref: 327 N. Front St

	Pounds	Kilo
Gross	78,500	35,607
Tare	27,060	12,274
Net	51,440	23,333
	25.72 Ton	23.33

	UNIT	TOTALS
Material:		
Freight:		
Tax:		
Fee / Fuel:		
Other Chrg:	No	

Today Tons:	77.59	Loads:
Tons To Date:	13,747.27	3
Today Tonnes	70.39	
Tonnes To Date:	12,471.31	

By acceptance of this ticket (with or without signature), driver accepts on behalf of themselves/their employer sole responsibility to ensure that the load received is within the weight limit authorized by law and shall hold seller harmless against any and all claims with respect to same CURB DELIVERY ONLY. NOT RESPONSIBLE FOR ANY DAMAGE BEYOND CURB.

Carrier: 8040648 GJ SCOTT LLC

Vehicle: GS6 GS6

License: AK761C

MaxGVW: 80,000

Received:

Cust:

Weighmaster: Colleen LeSage

P/D Status: Deliver

Customer Copy

Scale: 1



Plant: 32411

Berlin

368 New Brooklyn Road
Berlin, NJ 08009
856-809-0142

3/30/2017 07:24 In: 6:38:06
Customer: 8638404 THE AMBIENT GROUP LLC
Order: 950949 Camden, NJ. ABC Barrel Project
P.O.:

Tkt. No. 1006028155



Product 114203
Bank Run
S.O. Info: Camden, NJ.
Ship Ref: 327 N. Front St

	Pounds	Kilo
Gross	79,520	36,070
Tare	27,480	12,465
Net	52,040	23,605
	26.02 Ton	23.60

	UNIT	TOTALS
Material:		
Freight:		
Tax:		
Fee / Fuel:		
Other Chrg:	No	

Today Tons:	103.61	Loads:
Tons To Date:	13,773.29	4
Today Tonnes	93.99	
Tonnes To Date:	12,494.92	

By acceptance of this ticket (with or without signature), driver accepts on behalf of themselves/their employer sole responsibility to ensure that the load received is within the weight limit authorized by law and shall hold seller harmless against any and all claims with respect to same CURB DELIVERY ONLY. NOT RESPONSIBLE FOR ANY DAMAGE BEYOND CURB.

Carrier: 8040648 GJ SCOTT LLC

Vehicle: GS9 GS9

License: AK587X

MaxGVW: 80,000

Received:

Cust:

Weighmaster: Colleen LeSage

P/D Status: Deliver

Customer Copy

Scale: 1



Plant: 32411

Berlin

368 New Brooklyn Road
Berlin, NJ 08009
856-809-0142

3/30/2017 07:32

In: 6:43:04

Customer: 8638404 THE AMBIENT GROUP LLC

Order: 950949 Camden, NJ. ABC Barrel Project

P.O.:

Tkt. No. 1006028158

Product 114203

Bank Run

S.O. Info: Camden, NJ.

Ship Ref: 327 N. Front St



	Pounds	Kilo
Gross	78,940	35,807
Tare	28,180	12,782
Net	50,760	23,024

25.38 Ton 23.02

	UNIT	TOTALS
*Material:		
Freight:		
Tax:		
Fee / Fuel:		
Other Chrg:	No	

Today Tons:	128.99	Loads:
Tons To Date:	13,798.67	5
Today Tonnes	117.02	
Tonnes To Date:	12,517.94	

Carrier: 8040648 GJ SCOTT LLC

Vehicle: GS16 GS16

License: AT639K

MaxGVW: 80,000

Received:

Weighmaster: Colleen LeSage

Cust:

P/D Status: Deliver

By acceptance of this ticket (with or without signature), driver accepts on behalf of themselves/their employer sole responsibility to ensure that the load received is within the weight limit authorized by law and shall hold seller harmless against any and all claims with respect to same CURB DELIVERY ONLY. NOT RESPONSIBLE FOR ANY DAMAGE BEYOND CURB.

Customer Copy

Scale: 1



Plant: 32411

Berlin

368 New Brooklyn Road
Berlin, NJ 08009
856-809-0142

3/30/2017 07:39

In: 6:48:41

Customer: 8638404 THE AMBIENT GROUP LLC

Order: 950949 Camden, NJ. ABC Barrel Project

P.O.:

Tkt. No. 1006028161

Product 114203

Bank Run

S.O. Info: Camden, NJ.

Ship Ref: 327 N. Front St



	Pounds	Kilo
Gross	78,060	35,407
Tare	23,480	10,650
Net	54,580	24,757

27.29 Ton 24.76

	UNIT	TOTALS
Material:		
Freight:		
Tax:		
Fee / Fuel:		
Other Chrg:	No	

Today Tons:	156.28	Loads:
Tons To Date:	13,825.96	6
Today Tonnes	141.77	
Tonnes To Date:	12,542.70	

Carrier: 9285292 BLUESTONE CONTRACTING C

Vehicle: SB11 XDUX86

License: XDUX86

MaxGVW: 80,000

Received:

Weighmaster: Colleen LeSage

Cust:

P/D Status: Deliver

By acceptance of this ticket (with or without signature), driver accepts on behalf of themselves/their employer sole responsibility to ensure that the load received is within the weight limit authorized by law and shall hold seller harmless against any and all claims with respect to same CURB DELIVERY ONLY. NOT RESPONSIBLE FOR ANY DAMAGE BEYOND CURB.

Customer Copy

Scale: 1



Plant: 32411

Berlin

368 New Brooklyn Road
Berlin, NJ 08009
856-809-0142

3/30/2017 07:54

In: 7:01:39

Customer: 8638404 THE AMBIENT GROUP LLC

Order: 950949 Camden, NJ. ABC Barrel Project

P.O.:

Tkt. No. 1006028164



Product 114203

Bank Run

S.O. Info: Camden, NJ.

Ship Ref: 327 N. Front St

	Pounds	Kilo
Gross	78,180	35,462
Tare	27,460	12,456
Net	50,720	23,006

25.36 Ton 23.01

	UNIT	TOTALS
Material:		
Freight:		
Tax:		
Fee / Fuel:		
Other Chrg: No		

Today Tons:	181.64	Loads:
Tons To Date:	13,851.32	7
Today Tonnes	164.78	
Tonnes To Date:	12,565.71	

Carrier: 8960583 QW TRUCKING LLC

Vehicle: QW23 QW23

License: AT462B

MaxGVW: 80,000

Received: _____

Weighmaster: Colleen LeSage

P/D Status: Deliver

By acceptance of this ticket (with or without signature), driver accepts on behalf of themselves/their employer sole responsibility to ensure that the load received is within the weight limit authorized by law and shall hold seller harmless against any and all claims with respect to same CURB DELIVERY ONLY. NOT RESPONSIBLE FOR ANY DAMAGE BEYOND CURB.

Cust:

Customer Do Not Accept [1] Scale: 1



Plant: 32411

Berlin

368 New Brooklyn Road
Berlin, NJ 08009
856-809-0142

3/30/2017 07:57

In: 7:05:39

Customer: 8638404 THE AMBIENT GROUP LLC

Order: 950949 Camden, NJ. ABC Barrel Project

P.O.:

Tkt. No. 1006028165



Product 114203

Bank Run

S.O. Info: Camden, NJ.

Ship Ref: 327 N. Front St

	Pounds	Kilo
Gross	71,640	32,495
Tare	27,780	12,601
Net	43,860	19,895

21.93 Ton 19.89

	UNIT	TOTALS
Material:		
Freight:		
Tax:		
Fee / Fuel:		
Other Chrg: No		

Today Tons:	203.57	Loads:
Tons To Date:	13,873.25	8
Today Tonnes	184.68	
Tonnes To Date:	12,585.60	

Carrier: 8960583 QW TRUCKING LLC

Vehicle: QW7 QW7

License: AS914T

MaxGVW: 80,000

Received: _____

Weighmaster: Colleen LeSage

P/D Status: Deliver

By acceptance of this ticket (with or without signature), driver accepts on behalf of themselves/their employer sole responsibility to ensure that the load received is within the weight limit authorized by law and shall hold seller harmless against any and all claims with respect to same CURB DELIVERY ONLY. NOT RESPONSIBLE FOR ANY DAMAGE BEYOND CURB.

Cust: _____

Customer Copy Scale: 1



Plant: 32411

Berlin

368 New Brooklyn Road
Berlin, NJ 08009
856-809-0142

3/30/2017 07:59 In: 7:06:51
Customer: 8638404 THE AMBIENT GROUP LLC
Order : 950949 Camden, NJ. ABC Barrel Project
P.O. :

Tkt. No. 1006028166



Product 114203
Bank Run
S.O. Info: Camden, NJ.
Ship Ref: 327 N. Front St

	Pounds	Kilo
Gross	67,920	30,808
Tare	24,900	11,294
Net	43,020	19,514

21.51 Ton 19.51

UNIT	TOTALS
Material:	
Freight:	
Tax:	
Fee / Fuel:	
Other Chrg: <u>No</u>	

Today Tons:	225.08	Loads:
Tons To Date:	13,894.76	9
Today Tonnes	204.19	
Tonnes To Date:	12,605.11	

Carrier : 8960583 QW TRUCKING LLC

Vehicle: QW11 AS569P

License:

MaxGVW: 80,000

Received: Colleen LeSage

Weighmaster: Colleen LeSage

P/D Status: Deliver

Cust: _____

By acceptance of this ticket (with or without signature), driver accepts on behalf of themselves/their employer sole responsibility to ensure that the load received is within the weight limit authorized by law and shall hold seller harmless against any and all claims with respect to same CURB DELIVERY ONLY. NOT RESPONSIBLE FOR ANY DAMAGE BEYOND CURB.

Customer Copy

Scale: 1



Plant: 32411

Berlin

368 New Brooklyn Road
Berlin, NJ 08009
856-809-0142

3/30/2017 08:31 In: 8:10:33
Customer: 8638404 THE AMBIENT GROUP LLC
Order : 950949 Camden, NJ. ABC Barrel Project
P.O. :

Tkt. No. 1006028170



Product 114203
Bank Run
S.O. Info: Camden, NJ.
Ship Ref: 327 N. Front St

	Pounds	Kilo
Gross	76,880	34,872
Tare	24,880	11,285
Net	52,000	23,587

26.00 Ton 23.59

UNIT	TOTALS
Material:	
Freight:	
Tax:	
Fee / Fuel:	
Other Chrg: <u>No</u>	

Today Tons:	251.08	Loads:
Tons To Date:	13,920.76	10
Today Tonnes	227.78	
Tonnes To Date:	12,628.70	

Carrier : 8515471 CALLE TRUCKING LLC

Vehicle: CALLE5 Calle Trucking

License: AF49921

MaxGVW: 80,000

Received: _____

Weighmaster: Colleen LeSage

P/D Status: Deliver

Cust: _____

By acceptance of this ticket (with or without signature), driver accepts on behalf of themselves/their employer sole responsibility to ensure that the load received is within the weight limit authorized by law and shall hold seller harmless against any and all claims with respect to same CURB DELIVERY ONLY. NOT RESPONSIBLE FOR ANY DAMAGE BEYOND CURB.

Customer Copy

Scale: 1



Plant: 32411

Berlin

368 New Brooklyn Road
Berlin, NJ 08009
856-809-0142

3/30/2017 08:58

In :

Customer: 8638404 THE AMBIENT GROUP LLC

Order : 950949 Camden, NJ. ABC Barrel Project

P.O. :

Tkt. No. 1006028173

Product 114203

Bank Run

S.O. Info: Camden, NJ.

Ship Ref: 327 N. Front St



	Pounds	Kilo
Gross	79,960	36,269
Tare	28,020 *	12,710
Net	51,940	23,560

25.97 Ton 23.56

* Predetermined Tare

	UNIT	TOTALS
Material:		
Freight:		
Tax:		
Fee / Fuel:		
Other Chrg: No		

Today Tons:	277.05	Loads:
Tons To Date:	13,946.73	11
Today Tonnes	251.34	
Tonnes To Date:	12,652.26	

By acceptance of this ticket (with or without signature), driver accepts on behalf of themselves/their employer sole responsibility to ensure that the load received is within the weight limit authorized by law and shall hold seller harmless against any and all claims with respect to same CURB DELIVERY ONLY. NOT RESPONSIBLE FOR ANY DAMAGE BEYOND CURB.

Carrier : 8040648 GJ SCOTT LLC

Vehicle: GS17 GS17

License: AT640K

MaxGVW: 80,000

Received: _____

Cust: _____

Weighmaster: Colleen LeSage

P/D Status: Deliver

Customer Copy

Scale: 1



Plant: 32411

Berlin

368 New Brooklyn Road
Berlin, NJ 08009
856-809-0142

3/30/2017 09:04

In :

Customer: 8638404 THE AMBIENT GROUP LLC

Order : 950949 Camden, NJ. ABC Barrel Project

P.O. :

Tkt. No. 1006028175

Product 114203

Bank Run

S.O. Info: Camden, NJ.

Ship Ref: 327 N. Front St



	Pounds	Kilo
Gross	78,420	35,571
Tare	27,060 *	12,274
Net	51,360	23,297

25.68 Ton 23.30

* Predetermined Tare

	UNIT	TOTALS
Material:		
Freight:		
Tax:		
Fee / Fuel:		
Other Chrg: No		

Today Tons:	302.73	Loads:
Tons To Date:	13,972.41	12
Today Tonnes	274.63	
Tonnes To Date:	12,675.56	

By acceptance of this ticket (with or without signature), driver accepts on behalf of themselves/their employer sole responsibility to ensure that the load received is within the weight limit authorized by law and shall hold seller harmless against any and all claims with respect to same CURB DELIVERY ONLY. NOT RESPONSIBLE FOR ANY DAMAGE BEYOND CURB.

Carrier : 8040648 GJ SCOTT LLC

Vehicle: GS6 GS6

License: AK761C

MaxGVW: 80,000

Received: _____

Cust: _____

Weighmaster: Colleen LeSage

P/D Status: Deliver

Customer Do Not Accept [1]

Scale: 1



Plant: 32411

Berlin

368 New Brooklyn Road
Berlin, NJ 08009
856-809-0142

3/30/2017 09:10

In :

Customer: 8638404 THE AMBIENT GROUP LLC

Order : 950949 Camden, NJ. ABC Barrel Project

P.O. :

Tkt. No. 1006028176

Product 114203

Bank Run

S.O. Info: Camden, NJ.

Ship Ref: 327 N. Front St



	Pounds	Kilo
Gross	78,220	35,480
Tare	27,480 *	12,465
Net	50,740	23,015

25.37 Ton 23.02

* Predetermined Tare

	UNIT	TOTALS
Material:		
Freight:		
Tax:		
Fee / Fuel:		
Other Chrg: No		

Today Tons:	328.10	Loads:
Tons To Date:	13,997.78	13
Today Tonnes	297.65	
Tonnes To Date:	12,698.57	

By acceptance of this ticket (with or without signature), driver accepts on behalf of themselves/their employer sole responsibility to ensure that the load received is within the weight limit authorized by law and shall hold seller harmless against any and all claims with respect to same CURB DELIVERY ONLY. NOT RESPONSIBLE FOR ANY DAMAGE BEYOND CURB.

Carrier : 8040648 GJ SCOTT LLC

Vehicle: GS9 GS9

License: AK587X

MaxGVW: 80,000

Received:

Weighmaster: Colleen LeSage

Cust:

P/D Status: Deliver

Customer Copy

Scale: 1



Plant: 32411

Berlin

368 New Brooklyn Road
Berlin, NJ 08009
856-809-0142

3/30/2017 09:19

In :

Customer: 8638404 THE AMBIENT GROUP LLC

Order : 950949 Camden, NJ. ABC Barrel Project

P.O. :

Tkt. No. 1006028179

Product 114203

Bank Run

S.O. Info: Camden, NJ.

Ship Ref: 327 N. Front St



	Pounds	Kilo
Gross	78,260	35,498
Tare	28,180 *	12,782
Net	50,080	22,716

25.04 Ton 22.72

* Predetermined Tare

	UNIT	TOTALS
Material:		
Freight:		
Tax:		
Fee / Fuel:		
Other Chrg: No		

Today Tons:	353.14	Loads:
Tons To Date:	14,022.82	14
Today Tonnes	320.36	
Tonnes To Date:	12,721.29	

By acceptance of this ticket (with or without signature), driver accepts on behalf of themselves/their employer sole responsibility to ensure that the load received is within the weight limit authorized by law and shall hold seller harmless against any and all claims with respect to same CURB DELIVERY ONLY. NOT RESPONSIBLE FOR ANY DAMAGE BEYOND CURB.

Carrier : 8040648 GJ SCOTT LLC

Vehicle: GS16 GS16

License: AT639K

MaxGVW: 80,000

Received:

Weighmaster: Colleen LeSage

Cust:

P/D Status: Deliver

Customer Copy

Scale: 1



Plant: 32411

Berlin

368 New Brooklyn Road
Berlin, NJ 08009
856-809-0142

3/30/2017 09:32 In:
Customer: 8638404 THE AMBIENT GROUP LLC
Order : 950949 Camden, NJ. ABC Barrel Project
P.O. :

Tkt. No. 1006028184



Product 114203
Bank Run
S.O. Info: Camden, NJ.
Ship Ref: 327 N. Front St

	Pounds	Kilo
Gross	78,820	35,752
Tare	23,480 *	10,650
Net	55,340	25,102

27.67 Ton 25.10
* Predetermined Tare

	UNIT	TOTALS
Material:		
Freight:		
Tax:		
Fee / Fuel:		
Other Chrg: No		

Today Tons:	380.81	Loads:
Tons To Date:	14,050.49	15
Today Tonnes	345.46	
Tonnes To Date:	12,746.39	

Carrier : 9285292 BLUESTONE CONTRACTING C
Vehicle: SB11 XDUX86
License: XDUX86
MaxGVW: 80,000
Received: _____
Weighmaster: Colleen LeSage

By acceptance of this ticket (with or without signature), driver accepts on behalf of themselves/their employer sole responsibility to ensure that the load received is within the weight limit authorized by law and shall hold seller harmless against any and all claims with respect to same CURB DELIVERY ONLY. NOT RESPONSIBLE FOR ANY DAMAGE BEYOND CURB.

Cust: _____

P/D Status: Deliver

Customer Copy Scale: 1



Plant: 32411

Berlin

368 New Brooklyn Road
Berlin, NJ 08009
856-809-0142

3/30/2017 10:18 In:
Customer: 8638404 THE AMBIENT GROUP LLC
Order : 950949 Camden, NJ. ABC Barrel Project
P.O. :

Tkt. No. 1006028189



Product 114203
Bank Run
S.O. Info: Camden, NJ.
Ship Ref: 327 N. Front St

	Pounds	Kilo
Gross	73,420	33,303
Tare	24,880 *	11,285
Net	48,540	22,017

24.27 Ton 22.02
* Predetermined Tare

	UNIT	TOTALS
Material:		
Freight:		
Tax:		
Fee / Fuel:		
Other Chrg: No		

Today Tons:	405.08	Loads:
Tons To Date:	14,074.76	16
Today Tonnes	367.48	
Tonnes To Date:	12,768.41	

Carrier : 8515471 CALLE TRUCKING LLC
Vehicle: CALLE5 Calle Trucking
License: AF49921
MaxGVW: 80,000
Received: _____
Weighmaster: Colleen LeSage

By acceptance of this ticket (with or without signature), driver accepts on behalf of themselves/their employer sole responsibility to ensure that the load received is within the weight limit authorized by law and shall hold seller harmless against any and all claims with respect to same CURB DELIVERY ONLY. NOT RESPONSIBLE FOR ANY DAMAGE BEYOND CURB.

Cust: _____

P/D Status: Deliver

Customer Copy Scale: 1



Plant: 32411

Berlin

368 New Brooklyn Road
Berlin, NJ 08009
856-809-0142

3/30/2017 10:24

In :

Customer: 8638404 THE AMBIENT GROUP LLC

Order : 950949 Camden, NJ. ABC Barrel Project

P.O. :

Tkt. No. 1006028190

Product 114203

Bank Run

S.O. Info: Camden, NJ.

Ship Ref: 327 N. Front St



	Pounds	Kilo
Gross	73,600	33,384
Tare	27,460 *	12,456
Net	46,140	20,929

23.07 Ton 20.93

* Predetermined Tare

	UNIT	TOTALS
Material:		
Freight:		
Tax:		
Fee / Fuel:		
Other Chrg:	No	

Today Tons:	428.15	Loads:
Tons To Date:	14,097.83	17
Today Tonnes	388.41	
Tonnes To Date:	12,789.34	

Carrier : 8960583 QW TRUCKING LLC

Vehicle: QW23

License: AT462B

MaxGVW: 80,000

Received:

Weighmaster: Colleen LeSage

P/D Status: Deliver

By acceptance of this ticket (with or without signature), driver accepts on behalf of themselves/their employer sole responsibility to ensure that the load received is within the weight limit authorized by law and shall hold seller harmless against any and all claims with respect to same. CURB DELIVERY ONLY. NOT RESPONSIBLE FOR ANY DAMAGE BEYOND CURB.

Cust:

Customer Copy

Scale: 1



Plant: 32411

Berlin

368 New Brooklyn Road
Berlin, NJ 08009
856-809-0142

3/30/2017 10:26

In :

Customer: 8638404 THE AMBIENT GROUP LLC

Order : 950949 Camden, NJ. ABC Barrel Project

P.O. :

Tkt. No. 1006028191

Product 114203

Bank Run

S.O. Info: Camden, NJ.

Ship Ref: 327 N. Front St



	Pounds	Kilo
Gross	75,220	34,119
Tare	24,820 *	11,258
Net	50,400	22,861

25.20 Ton 22.86

* Predetermined Tare

	UNIT	TOTALS
Material:		
Freight:		
Tax:		
Fee / Fuel:		
Other Chrg:	No	

Today Tons:	453.35	Loads:
Tons To Date:	14,123.03	18
Today Tonnes	411.27	
Tonnes To Date:	12,812.20	

Carrier : 9070401 EAZY TRUCKING LLC

Vehicle: EAZY AS757R

License: AS757R

MaxGVW: 80,000

Received:

Weighmaster: Colleen LeSage

P/D Status: Deliver

By acceptance of this ticket (with or without signature), driver accepts on behalf of themselves/their employer sole responsibility to ensure that the load received is within the weight limit authorized by law and shall hold seller harmless against any and all claims with respect to same. CURB DELIVERY ONLY. NOT RESPONSIBLE FOR ANY DAMAGE BEYOND CURB.

Cust:

Customer Copy

Scale: 1



Plant: 32411

Berlin

368 New Brooklyn Road
Berlin, NJ 08009
856-809-0142

3/30/2017 10:29

In :

Customer: 8638404 THE AMBIENT GROUP LLC

Order : 950949 Camden, NJ. ABC Barrel Project

P.O. :

Tkt. No. 1006028192

Product 114203



Bank Run

S.O. Info: Camden, NJ.

Ship Ref: 327 N. Front St

	Pounds	Kilo
Gross	67,700	30,708
Tare	27,780 *	12,601
Net	39,920	18,107

19.96 Ton 18.11

* Predetermined Tare

	UNIT	TOTALS
Material:		
Freight:		
Tax:		
Fee / Fuel:		
Other Chrg:	No	

Today Tons:	473.31	Loads:
Tons To Date:	14,142.99	19
Today Tonnes	429.38	
Tonnes To Date:	12,830.30	

Carrier : 8960583 QW TRUCKING LLC

Vehicle: QW7 QW7

License: AS914T

MaxGVW: 80,000

Received:

Weighmaster: Colleen LeSage

By acceptance of this ticket (with or without signature), driver accepts on behalf of themselves/their employer sole responsibility to ensure that the load received is within the weight limit authorized by law and shall hold seller harmless against any and all claims with respect to same CURB DELIVERY ONLY. NOT RESPONSIBLE FOR ANY DAMAGE BEYOND CURB.

Cust: _____

P/D Status: Deliver

Customer Copy

Scale: 1



Plant: 32411

Berlin

368 New Brooklyn Road
Berlin, NJ 08009
856-809-0142

3/30/2017 10:31

In :

Customer: 8638404 THE AMBIENT GROUP LLC

Order : 950949 Camden, NJ. ABC Barrel Project

P.O. :

Tkt. No. 1006028193

Product 114203



Bank Run

S.O. Info: Camden, NJ.

Ship Ref: 327 N. Front St

	Pounds	Kilo
Gross	71,060	32,232
Tare	24,900 *	11,294
Net	46,160	20,938

23.08 Ton 20.94

* Predetermined Tare

	UNIT	TOTALS
Material:		
Freight:		
Tax:		
Fee / Fuel:		
Other Chrg:	No	

Today Tons:	496.39	Loads:
Tons To Date:	14,166.07	20
Today Tonnes	450.32	
Tonnes To Date:	12,851.24	

Carrier : 8960583 QW TRUCKING LLC

Vehicle: QW11 AS569P

License:

MaxGVW: 80,000

Received:

Weighmaster: Colleen LeSage

By acceptance of this ticket (with or without signature), driver accepts on behalf of themselves/their employer sole responsibility to ensure that the load received is within the weight limit authorized by law and shall hold seller harmless against any and all claims with respect to same CURB DELIVERY ONLY. NOT RESPONSIBLE FOR ANY DAMAGE BEYOND CURB.

Cust: _____

P/D Status: Deliver

Customer Copy

Scale: 1



Plant: 32411

Berlin

368 New Brooklyn Road
Berlin, NJ 08009
856-809-0142

3/30/2017 10:37

In :

Customer: 8638404 THE AMBIENT GROUP LLC

Order : 950949 Camden, NJ. ABC Barrel Project

P.O. :

Tkt. No. 1006028194



Product 114203

Bank Run

S.O. Info: Camden, NJ.

Ship Ref: 327 N. Front St

	Pounds	Kilo
Gross	78,760	35,725
Tare	27,060 *	12,274
Net	51,700	23,451

25.85 Ton 23.45

* Predetermined Tare

	UNIT	TOTALS
Material:		
Freight:		
Tax:		
Fee / Fuel:		
Other Chrg: No		

Today Tons:	522.24	Loads:
Tons To Date:	14,191.92	21
Today Tonnes	473.77	
Tonnes To Date:	12,874.69	

By acceptance of this ticket (with or without signature), driver accepts on behalf of themselves/their employer sole responsibility to ensure that the load received is within the weight limit authorized by law and shall hold seller harmless against any and all claims with respect to same. CURB DELIVERY ONLY. NOT RESPONSIBLE FOR ANY DAMAGE BEYOND CURB.

Carrier : 8040648 GJ SCOTT LLC

Vehicle: GS6 GS6

License: AK761C

MaxGVW: 80,000

Received:

Cust: _____

Weighmaster: Colleen LeSage

P/D Status: Deliver

Customer Do Not Accept [1] Scale: 1



Plant: 32411

Berlin

368 New Brooklyn Road
Berlin, NJ 08009
856-809-0142

3/30/2017 10:39

In :

Customer: 8638404 THE AMBIENT GROUP LLC

Order : 950949 Camden, NJ. ABC Barrel Project

P.O. :

Tkt. No. 1006028195



Product 114203

Bank Run

S.O. Info: Camden, NJ.

Ship Ref: 327 N. Front St

	Pounds	Kilo
Gross	77,560	35,181
Tare	27,480 *	12,465
Net	50,080	22,716

25.04 Ton 22.72

* Predetermined Tare

	UNIT	TOTALS
Material:		
Freight:		
Tax:		
Fee / Fuel:		
Other Chrg: No		

Today Tons:	547.28	Loads:
Tons To Date:	14,216.96	22
Today Tonnes	496.48	
Tonnes To Date:	12,897.41	

By acceptance of this ticket (with or without signature), driver accepts on behalf of themselves/their employer sole responsibility to ensure that the load received is within the weight limit authorized by law and shall hold seller harmless against any and all claims with respect to same. CURB DELIVERY ONLY. NOT RESPONSIBLE FOR ANY DAMAGE BEYOND CURB.

Carrier : 8040648 GJ SCOTT LLC

Vehicle: GS9 GS9

License: AK587X

MaxGVW: 80,000

Received:

Cust: _____

Weighmaster: Colleen LeSage

P/D Status: Deliver

Customer Do Not Accept [1] Scale: 1



Plant: 32411

Berlin

368 New Brooklyn Road
Berlin, NJ 08009
856-809-0142

3/30/2017 10:40 In :
Customer: 8638404 THE AMBIENT GROUP LLC
Order : 950949 Camden, NJ. ABC Barrel Project
P.O. :

Tkt. No. 1006028196

Product 114203
Bank Run
S.O. Info: Camden, NJ.
Ship Ref: 327 N. Front St



	UNIT	TOTALS
Material:		
Freight:		
Tax:		
Fee / Fuel:		
Other Chrg: No		

	Pounds	Kilo
Gross	78,920	35,798
Tare	28,020 *	12,710
Net	50,900	23,088

25.45 Ton 23.09
* Predetermined Tare

Today Tons:	572.73	Loads:
Tons To Date:	14,242.41	23
Today Tonnes	519.57	
Tonnes To Date:	12,920.50	

Carrier : 8040648 GJ SCOTT LLC
Vehicle: GS17 GS17
License: AT640K
MaxGVW: 80,000

By acceptance of this ticket (with or without signature), driver accepts on behalf of themselves/their employer sole responsibility to ensure that the load received is within the weight limit authorized by law and shall hold seller harmless against any and all claims with respect to same CURB DELIVERY ONLY. NOT RESPONSIBLE FOR ANY DAMAGE BEYOND CURB.

Received: _____
Weighmaster: Colleen LeSage

Cust: _____

P/D Status: Deliver

Customer Copy

Scale: 1



Plant: 32411

Berlin

368 New Brooklyn Road
Berlin, NJ 08009
856-809-0142

3/30/2017 10:42 In :
Customer: 8638404 THE AMBIENT GROUP LLC
Order : 950949 Camden, NJ. ABC Barrel Project
P.O. :

Tkt. No. 1006028197

Product 114203
Bank Run
S.O. Info: Camden, NJ.
Ship Ref: 327 N. Front St



	UNIT	TOTALS
Material:		
Freight:		
Tax:		
Fee / Fuel:		
Other Chrg: No		

	Pounds	Kilo
Gross	78,580	35,643
Tare	28,180 *	12,782
Net	50,400	22,861

25.20 Ton 22.86
* Predetermined Tare

Today Tons:	597.93	Loads:
Tons To Date:	14,267.61	24
Today Tonnes	542.43	
Tonnes To Date:	12,943.36	

By acceptance of this ticket (with or without signature), driver accepts on behalf of themselves/their employer sole responsibility to ensure that the load received is within the weight limit authorized by law and shall hold seller harmless against any and all claims with respect to same CURB DELIVERY ONLY. NOT RESPONSIBLE FOR ANY DAMAGE BEYOND CURB.

Carrier : 8040648 GJ SCOTT LLC
Vehicle: GS16 GS16
License: AT639K
MaxGVW: 80,000

Cust: _____

Received: _____
Weighmaster: Colleen LeSage

P/D Status: Deliver

Customer Copy

Scale: 1



Plant: 32411

Berlin

368 New Brooklyn Road
Berlin, NJ 08009
856-809-0142

3/30/2017 11:11

In :

Customer: 8638404 THE AMBIENT GROUP LLC

Order : 950949 Camden, NJ. ABC Barrel Project

P.O. :

Tkt. No. 1006028203

Product 114203

Bank Run

S.O. Info: Camden, NJ.

Ship Ref: 327 N. Front St



	Pounds	Kilo
Gross	74,340	33,720
Tare	23,480 *	10,650
Net	50,860	23,070

25.43 Ton 23.07

* Predetermined Tare

Today Tons:	623.36	Loads:
Tons To Date:	14,293.04	25
Today Tonnes	565.50	
Tonnes To Date:	12,966.43	

	UNIT	TOTALS
Material:		
Freight:		
Tax:		
Fee / Fuel:		
Other Chrg:	No	

Carrier : 9285292 BLUESTONE CONTRACTING C

Vehicle: SB11 XDUX86

License: XDUX86

MaxGVW: 80,000

Received: _____

Weighmaster: Colleen LeSage

Cust: _____

P/D Status: Deliver

By acceptance of this ticket (with or without signature), driver accepts on behalf of themselves/their employer sole responsibility to ensure that the load received is within the weight limit authorized by law and shall hold seller harmless against any and all claims with respect to same CURB DELIVERY ONLY. NOT RESPONSIBLE FOR ANY DAMAGE BEYOND CURB.

Customer Copy

Scale: 1



Plant: 32411

Berlin

368 New Brooklyn Road
Berlin, NJ 08009
856-809-0142

3/30/2017 11:46

In :

Customer: 8638404 THE AMBIENT GROUP LLC

Order : 950949 Camden, NJ. ABC Barrel Project

P.O. :

Tkt. No. 1006028204

Product 114203

Bank Run

S.O. Info: Camden, NJ.

Ship Ref: 327 N. Front St



	Pounds	Kilo
Gross	74,080	33,602
Tare	24,880 *	11,285
Net	49,200	22,317

24.60 Ton 22.32

* Predetermined Tare

Today Tons:	647.96	Loads:
Tons To Date:	14,317.64	26
Today Tonnes	587.82	
Tonnes To Date:	12,988.74	

	UNIT	TOTALS
Material:		
Freight:		
Tax:		
Fee / Fuel:		
Other Chrg:	No	

Carrier : 8515471 CALLE TRUCKING LLC

Vehicle: CALLE5 Calle Trucking

License: AF49921

MaxGVW: 80,000

Received: _____

Weighmaster: Colleen LeSage

Cust: _____

P/D Status: Deliver

By acceptance of this ticket (with or without signature), driver accepts on behalf of themselves/their employer sole responsibility to ensure that the load received is within the weight limit authorized by law and shall hold seller harmless against any and all claims with respect to same CURB DELIVERY ONLY. NOT RESPONSIBLE FOR ANY DAMAGE BEYOND CURB.

Customer Copy

Scale: 1



Plant: 32411

Berlin

368 New Brooklyn Road
Berlin, NJ 08009
856-809-0142

3/30/2017 12:00

In :

Customer: 8638404 THE AMBIENT GROUP LLC

Order : 950949 Camden, NJ. ABC Barrel Project

P.O. :

Tkt. No. 1006028207

Product 114203

Bank Run

S.O. Info: Camden, NJ.

Ship Ref: 327 N. Front St



	Pounds	Kilo
Gross	75,300	34,155
Tare	27,460 *	12,456
Net	47,840	21,700

23.92 Ton 21.70

* Predetermined Tare

Today Tons:	671.88	Loads:
Tons To Date:	14,341.56	27
Today Tonnes	609.52	
Tonnes To Date:	13,010.44	

	UNIT	TOTALS
Material:		
Freight:		
Tax:		
Fee / Fuel:		
Other Chrg:	No	

Carrier : 8960583 QW TRUCKING LLC

Vehicle: QW23 QW23

License: AT462B

MaxGVW: 80,000

Received:

Weighmaster: Colleen LeSage

By acceptance of this ticket (with or without signature), driver accepts on behalf of themselves/their employer sole responsibility to ensure that the load received is within the weight limit authorized by law and shall hold seller harmless against any and all claims with respect to same CURB DELIVERY ONLY. NOT RESPONSIBLE FOR ANY DAMAGE BEYOND CURB.

Cust: _____

P/D Status: Deliver

Customer Copy

Scale: 1



Plant: 32411

Berlin

368 New Brooklyn Road
Berlin, NJ 08009
856-809-0142

3/30/2017 12:05

In :

Customer: 8638404 THE AMBIENT GROUP LLC

Order : 950949 Camden, NJ. ABC Barrel Project

P.O. :

Tkt. No. 1006028208

Product 114203

Bank Run

S.O. Info: Camden, NJ.

Ship Ref: 327 N. Front St



	Pounds	Kilo
Gross	75,260	34,137
Tare	27,060 *	12,274
Net	48,200	21,863

24.10 Ton 21.86

* Predetermined Tare

Today Tons:	695.98	Loads:
Tons To Date:	14,365.66	28
Today Tonnes	631.38	
Tonnes To Date:	13,032.31	

	UNIT	TOTALS
Material:		
Freight:		
Tax:		
Fee / Fuel:		
Other Chrg:	No	

Carrier : 8040648 GJ SCOTT LLC

Vehicle: GS6 GS6

License: AK761C

MaxGVW: 80,000

Received:

Weighmaster: Colleen LeSage

By acceptance of this ticket (with or without signature), driver accepts on behalf of themselves/their employer sole responsibility to ensure that the load received is within the weight limit authorized by law and shall hold seller harmless against any and all claims with respect to same CURB DELIVERY ONLY. NOT RESPONSIBLE FOR ANY DAMAGE BEYOND CURB.

Cust: _____

P/D Status: Deliver

Customer Copy

Scale: 1



Plant: 32411

Berlin

368 New Brooklyn Road
Berlin, NJ 08009
856-809-0142

3/30/2017 12:07 In :
Customer: 8638404 THE AMBIENT GROUP LLC
Order : 950949 Camden, NJ. ABC Barrel Project
P.O. :

Tkt. No. 1006028209



Product 114203
Bank Run
S.O. Info: Camden, NJ.
Ship Ref: 327 N. Front St

	Pounds	Kilo
Gross	75,300	34,155
Tare	27,480 *	12,465
Net	47,820	21,691

23.91 Ton 21.69

* Predetermined Tare

	UNIT	TOTALS
Material:		
Freight:		
Tax:		
Fee / Fuel:		
Other Chrg:	No	

Today Tons:	719.89	Loads:
Tons To Date:	14,389.57	29
Today Tonnes	653.07	
Tonnes To Date:	13,054.00	

By acceptance of this ticket (with or without signature), driver accepts on behalf of themselves/their employer sole responsibility to ensure that the load received is within the weight limit authorized by law and shall hold seller harmless against any and all claims with respect to same. CURB DELIVERY ONLY. NOT RESPONSIBLE FOR ANY DAMAGE BEYOND CURB.

Carrier : 8040648 GJ SCOTT LLC
Vehicle: GS9 GS9
License: AK587X
MaxGVW: 80,000

Received:
Weighmaster: Colleen LeSage

Cust:

P/D Status: Deliver

Customer Copy

Scale: 1



Plant: 32411

Berlin

368 New Brooklyn Road
Berlin, NJ 08009
856-809-0142

3/30/2017 12:15 In :
Customer: 8638404 THE AMBIENT GROUP LLC
Order : 950949 Camden, NJ. ABC Barrel Project
P.O. :

Tkt. No. 1006028212



Product 114203
Bank Run
S.O. Info: Camden, NJ.
Ship Ref: 327 N. Front St

	Pounds	Kilo
Gross	78,460	35,589
Tare	28,180 *	12,782
Net	50,280	22,807

25.14 Ton 22.81

* Predetermined Tare

	UNIT	TOTALS
Material:		
Freight:		
Tax:		
Fee / Fuel:		
Other Chrg:	No	

Today Tons:	745.03	Loads:
Tons To Date:	14,414.71	30
Today Tonnes	675.88	
Tonnes To Date:	13,076.80	

By acceptance of this ticket (with or without signature), driver accepts on behalf of themselves/their employer sole responsibility to ensure that the load received is within the weight limit authorized by law and shall hold seller harmless against any and all claims with respect to same. CURB DELIVERY ONLY. NOT RESPONSIBLE FOR ANY DAMAGE BEYOND CURB.

Carrier : 8040648 GJ SCOTT LLC
Vehicle: GS16 GS16
License: AT639K
MaxGVW: 80,000

Received:
Weighmaster: Colleen LeSage

Cust: _____

P/D Status: Deliver

Customer Copy

Scale: 1



Plant: 32411

Berlin

368 New Brooklyn Road
Berlin, NJ 08009
856-809-0142

3/30/2017 12:20

In :

Customer: 8638404 THE AMBIENT GROUP LLC

Order : 950949 Camden, NJ. ABC Barrel Project

P.O. :

Tkt. No. 1006028213

Product 114203



Bank Run

S.O. Info: Camden, NJ.

Ship Ref: 327 N. Front St

	Pounds	Kilo
Gross	71,380	32,377
Tare	27,780 *	12,601
Net	43,600	19,777

21.80 Ton 19.78

* Predetermined Tare

	UNIT	TOTALS
Material:		
Freight:		
Tax:		
Fee / Fuel:		
Other Chrg: No		

Today Tons:	766.83	Loads:
Tons To Date:	14,436.51	31
Today Tonnes:	695.66	
Tonnes To Date:	13,096.58	

Carrier : 8960583 QW TRUCKING LLC

Vehicle: QW7 QW7

License: AS914T

MaxGVW: 80,000

Received: *[Signature]*

Weighmaster: Colleen LeSage

Cust: _____

P/D Status: Deliver

Customer Do Not Accept [11] Scale: 1

By acceptance of this ticket (with or without signature), driver accepts on behalf of themselves/their employer sole responsibility to ensure that the load received is within the weight limit authorized by law and shall hold seller harmless against any and all claims with respect to same CURB DELIVERY ONLY, NOT RESPONSIBLE FOR ANY DAMAGE BEYOND CURB.



Plant: 32411

Berlin

368 New Brooklyn Road
Berlin, NJ 08009
856-809-0142

3/30/2017 12:22

In :

Customer: 8638404 THE AMBIENT GROUP LLC

Order : 950949 Camden, NJ. ABC Barrel Project

P.O. :

Tkt. No. 1006028214

Product 114203



Bank Run

S.O. Info: Camden, NJ.

Ship Ref: 327 N. Front St

	Pounds	Kilo
Gross	71,840	32,586
Tare	24,900 *	11,294
Net	46,940	21,292

23.47 Ton 21.29

* Predetermined Tare

	UNIT	TOTALS
Material:		
Freight:		
Tax:		
Fee / Fuel:		
Other Chrg: No		

Today Tons:	790.30	Loads:
Tons To Date:	14,459.98	32
Today Tonnes:	716.95	
Tonnes To Date:	13,117.87	

Carrier : 8960583 QW TRUCKING LLC

Vehicle: QW11 AS569P

License:

MaxGVW: 80,000

Received: *[Signature]*

Weighmaster: Colleen LeSage

Cust: _____

P/D Status: Deliver

Customer Copy Scale: 1

By acceptance of this ticket (with or without signature), driver accepts on behalf of themselves/their employer sole responsibility to ensure that the load received is within the weight limit authorized by law and shall hold seller harmless against any and all claims with respect to same CURB DELIVERY ONLY, NOT RESPONSIBLE FOR ANY DAMAGE BEYOND CURB.



Plant: 32411

Berlin

368 New Brooklyn Road
Berlin, NJ 08009
856-809-0142

3/30/2017 12:23

In :

Customer: 8638404 THE AMBIENT GROUP LLC

Order : 950949 Camden, NJ. ABC Barrel Project

P.O. :

Tkt. No. 1006028215

Product 114203

Bank Run

S.O. Info: Camden, NJ.

Ship Ref: 327 N. Front St



	Pounds	Kilo
Gross	76,760	34,818
Tare	28,020 *	12,710
Net	48,740	22,108

24.37 Ton 22.11

* Predetermined Tare

Today Tons:	814.67	Loads:
Tons To Date:	14,484.35	33
Today Tonnes	739.06	
Tonnes To Date:	13,139.98	

	UNIT	TOTALS
Material:		
Freight:		
Tax:		
Fee / Fuel:		
Other Chrg: No		

Carrier : 8040648 GJ SCOTT LLC

Vehicle: GS17 GS17

License: AT640K

MaxGVW: 80,000

Received: _____

Cust: _____

Weighmaster: Colleen LeSage

P/D Status: Deliver

Customer Copy

Scale: 1

By acceptance of this ticket (with or without signature), driver accepts on behalf of themselves/their employer sole responsibility to ensure that the load received is within the weight limit authorized by law and shall hold seller harmless against any and all claims with respect to same CURB DELIVERY ONLY. NOT RESPONSIBLE FOR ANY DAMAGE BEYOND CURB.



Plant: 32411

Berlin

368 New Brooklyn Road
Berlin, NJ 08009
856-809-0142

3/30/2017 12:44

In :

Customer: 8638404 THE AMBIENT GROUP LLC

Order : 950949 Camden, NJ. ABC Barrel Project

P.O. :

Tkt. No. 1006028220

Product 114203

Bank Run

S.O. Info: Camden, NJ.

Ship Ref: 327 N. Front St



	Pounds	Kilo
Gross	76,800	34,836
Tare	23,480 *	10,650
Net	53,320	24,186

26.66 Ton 24.19

* Predetermined Tare

Today Tons:	841.33	Loads:
Tons To Date:	14,511.01	34
Today Tonnes	763.24	
Tonnes To Date:	13,164.17	

	UNIT	TOTALS
Material:		
Freight:		
Tax:		
Fee / Fuel:		
Other Chrg: No		

Carrier : 9285292 BLUESTONE CONTRACTING C

Vehicle: SB11 XDUX86

License: XDUX86

MaxGVW: 80,000

Received: _____

Cust: _____

Weighmaster: Colleen LeSage

P/D Status: Deliver

Customer Do Not Accept [2]

Scale: 1

By acceptance of this ticket (with or without signature), driver accepts on behalf of themselves/their employer sole responsibility to ensure that the load received is within the weight limit authorized by law and shall hold seller harmless against any and all claims with respect to same CURB DELIVERY ONLY. NOT RESPONSIBLE FOR ANY DAMAGE BEYOND CURB.



Plant: 32411

Berlin

368 New Brooklyn Road
Berlin, NJ 08009
856-809-0142

3/30/2017 13:33

In:

Customer: 8638404 THE AMBIENT GROUP LLC

Order: 950949 Camden, NJ. ABC Barrel Project

P.O.:

Tkt. No. 1006028224

Product 114203

Bank Run

S.O. Info: Camden, NJ.

Ship Ref: 327 N. Front St



	Pounds	Kilo
Gross	73,340	33,266
Tare	27,060 *	12,274
Net	46,280	20,992

23.14 Ton 20.99

* Predetermined Tare

	UNIT	TOTALS
Material:		
Freight:		
Tax:		
Fee / Fuel:		
Other Chrg:	No	

Today Tons:	889.55	Loads:
Tons To Date:	14,559.23	36
Today Tonnes	806.99	
Tonnes To Date:	13,207.91	

Carrier: 8040648 GJ SCOTT LLC

Vehicle: GS6 GS6

License: AK761C

MaxGVW: 80,000

Received:

Weighmaster: Colleen LeSage

Cust:

P/D Status: Deliver

By acceptance of this ticket (with or without signature), driver accepts on behalf of themselves/their employer sole responsibility to ensure that the load received is within the weight limit authorized by law and shall hold seller harmless against any and all claims with respect to same CURB DELIVERY ONLY. NOT RESPONSIBLE FOR ANY DAMAGE BEYOND CURB.

Customer Copy

Scale: 1



Plant: 32411

Berlin

368 New Brooklyn Road
Berlin, NJ 08009
856-809-0142

3/30/2017 13:42

In:

Customer: 8638404 THE AMBIENT GROUP LLC

Order: 950949 Camden, NJ. ABC Barrel Project

P.O.:

Tkt. No. 1006028226

Product 114203

Bank Run

S.O. Info: Camden, NJ.

Ship Ref: 327 N. Front St



	Pounds	Kilo
Gross	77,300	35,063
Tare	27,480 *	12,465
Net	49,820	22,598

24.91 Ton 22.60

* Predetermined Tare

	UNIT	TOTALS
Material:		
Freight:		
Tax:		
Fee / Fuel:		
Other Chrg:	No	

Today Tons:	914.46	Loads:
Tons To Date:	14,584.14	37
Today Tonnes	829.58	
Tonnes To Date:	13,230.51	

Carrier: 8040648 GJ SCOTT LLC

Vehicle: GS9 GS9

License: AK587X

MaxGVW: 80,000

Received:

Weighmaster: Colleen LeSage

Cust:

P/D Status: Deliver

By acceptance of this ticket (with or without signature), driver accepts on behalf of themselves/their employer sole responsibility to ensure that the load received is within the weight limit authorized by law and shall hold seller harmless against any and all claims with respect to same CURB DELIVERY ONLY. NOT RESPONSIBLE FOR ANY DAMAGE BEYOND CURB.

Customer Copy

Scale: 1



Plant: 32411

Berlin
368 New Brooklyn Road
Berlin, NJ 08009
856-809-0142

3/30/2017 13:45 In :
Customer: 8638404 THE AMBIENT GROUP LLC
Order : 950949 Camden, NJ. ABC Barrel Project
P.O. :

Tkt. No. 1006028227



Product 114203
Bank Run
S.O. Info: Camden, NJ.
Ship Ref: 327 N. Front St

	Pounds	Kilo
Gross	76,500	34,700
Tare	28,180 *	12,782
Net	48,320	21,918

24.16 Ton 21.92
* Predetermined Tare

UNIT	TOTALS
Material:	
Freight:	
Tax:	
Fee / Fuel:	
Other Chrg: No	

Today Tons:	938.62	Loads:
Tons To Date:	14,608.30	38
Today Tonnes	851.50	
Tonnes To Date:	13,252.43	

Carrier : 8040648 GJ SCOTT LLC
Vehicle: GS16 GS16
License: AT639K
MaxGVW: 80,000

By acceptance of this ticket (with or without signature), driver accepts on behalf of themselves/their employer sole responsibility to ensure that the load received is within the weight limit authorized by law and shall hold seller harmless against any and all claims with respect to same CURB DELIVERY ONLY. NOT RESPONSIBLE FOR ANY DAMAGE BEYOND CURB.

Received: _____
Weighmaster: Colleen LeSage

Cust: _____

P/D Status: Deliver

Customer Do Not Accept [2] Scale: 1



Plant: 32411

Berlin
368 New Brooklyn Road
Berlin, NJ 08009
856-809-0142

3/30/2017 13:52 In :
Customer: 8638404 THE AMBIENT GROUP LLC
Order : 950949 Camden, NJ. ABC Barrel Project
P.O. :

Tkt. No. 1006028229



Product 114203
Bank Run
S.O. Info: Camden, NJ.
Ship Ref: 327 N. Front St

	Pounds	Kilo
Gross	77,940	35,353
Tare	28,020 *	12,710
Net	49,920	22,643

24.96 Ton 22.64
* Predetermined Tare

UNIT	TOTALS
Material:	
Freight:	
Tax:	
Fee / Fuel:	
Other Chrg: No	

Today Tons:	963.58	Loads:
Tons To Date:	14,633.26	39
Today Tonnes	874.14	
Tonnes To Date:	13,275.07	

Carrier : 8040648 GJ SCOTT LLC
Vehicle: GS17 GS17
License: AT640K
MaxGVW: 80,000

By acceptance of this ticket (with or without signature), driver accepts on behalf of themselves/their employer sole responsibility to ensure that the load received is within the weight limit authorized by law and shall hold seller harmless against any and all claims with respect to same CURB DELIVERY ONLY. NOT RESPONSIBLE FOR ANY DAMAGE BEYOND CURB.

Received: _____
Weighmaster: Colleen LeSage

Cust: _____

P/D Status: Deliver

Customer Copy Scale: 1



Plant: 32411

Berlin

368 New Brooklyn Road
Berlin, NJ 08009
856-809-0142

4/3/2017 07:12 In: 6:38:01
Customer: 8638404 THE AMBIENT GROUP LLC
Order : 950949 Camden, NJ. ABC Barrel Project
P.O. :

Tkt. No. 1006028256



Product 114203
Bank Run
S.O. Info: Camden, NJ.
Ship Ref: 327 N. Front St

	Pounds	Kilo
Gross	79,520	36,070
Tare	24,760	11,231
Net	54,760	24,839
	27.38 Ton	24.84

	UNIT	TOTALS
Material:		
Freight:		
Tax:		
Fee / Fuel:		
Other Chrg: No		

Today Tons:	27.38	Loads:
Tons To Date:	14,660.64	1
Today Tonnes	24.84	
Tonnes To Date:	13,299.91	

By acceptance of this ticket (with or without signature), driver accepts on behalf of themselves/their employer sole responsibility to ensure that the load received is within the weight limit authorized by law and shall hold seller harmless against any and all claims with respect to same CURB DELIVERY ONLY. NOT RESPONSIBLE FOR ANY DAMAGE BEYOND CURB.

Carrier : 9070401 EAZY TRUCKING LLC
Vehicle: EAZY1 AS757R
License: AS757R
MaxGVW: 80,000

Received: _____
Weighmaster: Colleen LeSage

Cust: _____

P/D Status: Deliver

Customer Copy

Scale: 1



Plant: 32411

Berlin

368 New Brooklyn Road
Berlin, NJ 08009
856-809-0142

4/3/2017 07:14 In: 6:39:18
Customer: 8638404 THE AMBIENT GROUP LLC
Order : 950949 Camden, NJ. ABC Barrel Project
P.O. :

Tkt. No. 1006028257



Product 114203
Bank Run
S.O. Info: Camden, NJ.
Ship Ref: 327 N. Front St

	Pounds	Kilo
Gross	79,520	36,070
Tare	28,700	13,018
Net	50,820	23,052
	25.41 Ton	23.05

	UNIT	TOTALS
Material:		
Freight:		
Tax:		
Fee / Fuel:		
Other Chrg: No		

Today Tons:	52.79	Loads:
Tons To Date:	14,686.05	2
Today Tonnes	47.89	
Tonnes To Date:	13,322.96	

By acceptance of this ticket (with or without signature), driver accepts on behalf of themselves/their employer sole responsibility to ensure that the load received is within the weight limit authorized by law and shall hold seller harmless against any and all claims with respect to same CURB DELIVERY ONLY. NOT RESPONSIBLE FOR ANY DAMAGE BEYOND CURB.

Carrier : 8040648 GJ SCOTT LLC
Vehicle: GS15 GS15
License: AS672T
MaxGVW: 80,000

Received: _____
Weighmaster: Colleen LeSage

Cust: _____

P/D Status: Deliver

Customer Copy

Scale: 1



Plant: 32411

Berlin

368 New Brooklyn Road
Berlin, NJ 08009
856-809-0142

4/3/2017 07:16

In: 6:41:27

Customer: 8638404 THE AMBIENT GROUP LLC

Order : 950949 Camden, NJ. ABC Barrel Project

P.O. :

Tkt. No. 1006028258



Product 114203

Bank Run

S.O. Info: Camden, NJ.

Ship Ref: 327 N. Front St

	Pounds	Kilo
Gross	77,860	35,317
Tare	27,100	12,292
Net	50,760	23,024
	25.38 Ton	23.02

	UNIT	TOTALS
Material:		
Freight:		
Tax:		
Fee / Fuel:		
Other Chrg: No		

Today Tons:	78.17	Loads:
Tons To Date:	14,711.43	3
Today Tonnes	70.91	
Tonnes To Date:	13,345.98	

Carrier : 8040648 GJ SCOTT LLC

Vehicle: GS6 GS6

License: AK761C

MaxGVW: 80,000

Received: _____

Weighmaster: Colleen LeSage

P/D Status: Deliver

Cust: _____

By acceptance of this ticket (with or without signature), driver accepts on behalf of themselves/their employer sole responsibility to ensure that the load received is within the weight limit authorized by law and shall hold seller harmless against any and all claims with respect to same
CURB DELIVERY ONLY. NOT RESPONSIBLE FOR ANY DAMAGE BEYOND CURB.

Customer Do Not Accept [1] Scale: 1



Plant: 32411

Berlin

368 New Brooklyn Road
Berlin, NJ 08009
856-809-0142

4/3/2017 07:18

In: 6:41:50

Customer: 8638404 THE AMBIENT GROUP LLC

Order : 950949 Camden, NJ. ABC Barrel Project

P.O. :

Tkt. No. 1006028259



Product 114203

Bank Run

S.O. Info: Camden, NJ.

Ship Ref: 327 N. Front St

	Pounds	Kilo
Gross	78,180	35,462
Tare	28,260	12,819
Net	49,920	22,643
	24.96 Ton	22.64

	UNIT	TOTALS
Material:		
Freight:		
Tax:		
Fee / Fuel:		
Other Chrg: No		

Today Tons:	103.13	Loads:
Tons To Date:	14,736.39	4
Today Tonnes	93.56	
Tonnes To Date:	13,368.63	

Carrier : 8040648 GJ SCOTT LLC

Vehicle: GS17 GS17

License: AT640K

MaxGVW: 80,000

Received: _____

Weighmaster: Colleen LeSage

P/D Status: Deliver

Cust: _____

By acceptance of this ticket (with or without signature), driver accepts on behalf of themselves/their employer sole responsibility to ensure that the load received is within the weight limit authorized by law and shall hold seller harmless against any and all claims with respect to same
CURB DELIVERY ONLY. NOT RESPONSIBLE FOR ANY DAMAGE BEYOND CURB.

Customer Copy Scale: 1



Plant: 32411

Berlin

368 New Brooklyn Road
Berlin, NJ 08009
856-809-0142

4/3/2017 07:19 In: 6:41:06
Customer: 8638404 THE AMBIENT GROUP LLC
Order: 950949 Camden, NJ. ABC Barrel Project
P.O.:

Tkt. No. 1006028260

Product 114203
Bank Run
S.O. Info: Camden, NJ.
Ship Ref: 327 N. Front St



	Pounds	Kilo
Gross	76,180	34,555
Tare	28,780	13,054
Net	47,400	21,500
	23.70 Ton	21.50

	UNIT	TOTALS
Material:		
Freight:		
Tax:		
Fee / Fuel:		
Other Chrg: No		

Today Tons:	126.83	Loads:
Tons To Date:	14,760.09	5
Today Tonnes	115.06	
Tonnes To Date:	13,390.13	

Carrier: 8040648 GJ SCOTT LLC
Vehicle: GS14 GS14
License: As672T
MaxGVW: 80,000
Received:
Weighmaster: Colleen LeSage

By acceptance of this ticket (with or without signature), driver accepts on behalf of themselves/their employer sole responsibility to ensure that the load received is within the weight limit authorized by law and shall hold seller harmless against any and all claims with respect to same
CURB DELIVERY ONLY. NOT RESPONSIBLE FOR ANY DAMAGE BEYOND CURB.

Cust:

P/D Status: Deliver

Customer Do Not Accept [1] Scale: 1



Plant: 32411

Berlin

368 New Brooklyn Road
Berlin, NJ 08009
856-809-0142

4/3/2017 07:20 In: 6:42:18
Customer: 8638404 THE AMBIENT GROUP LLC
Order: 950949 Camden, NJ. ABC Barrel Project
P.O.:

Tkt. No. 1006028261

Product 114203
Bank Run
S.O. Info: Camden, NJ.
Ship Ref: 327 N. Front St



	Pounds	Kilo
Gross	79,220	35,934
Tare	28,140	12,764
Net	51,080	23,169
	25.54 Ton	23.17

	UNIT	TOTALS
Material:		
Freight:		
Tax:		
Fee / Fuel:		
Other Chrg: No		

Today Tons:	152.37	Loads:
Tons To Date:	14,785.63	6
Today Tonnes	138.23	
Tonnes To Date:	13,413.30	

Carrier: 9249110 CLM CONTRACTING LLC
Vehicle: CLM6 CLM6
License: AT597T
MaxGVW: 80,000
Received:
Weighmaster: Colleen LeSage

By acceptance of this ticket (with or without signature), driver accepts on behalf of themselves/their employer sole responsibility to ensure that the load received is within the weight limit authorized by law and shall hold seller harmless against any and all claims with respect to same
CURB DELIVERY ONLY. NOT RESPONSIBLE FOR ANY DAMAGE BEYOND CURB.

Cust:

P/D Status: Deliver

Customer Copy Scale: 1



Plant: 32411

Berlin

368 New Brooklyn Road
Berlin, NJ 08009
856-809-0142

4/3/2017 07:22 In: 6:42:45
Customer: 8638404 THE AMBIENT GROUP LLC
Order : 950949 Camden, NJ. ABC Barrel Project
P.O. :

Tkt. No. 1006028262



Product 114203
Bank Run
S.O. Info: Camden, NJ
Ship Ref: 327 N. Front St

	Pounds	Kilo
Gross	77,460	35,135
Tare	28,040	12,719
Net	49,420	22,417
	24.71 Ton	22.42

	UNIT	TOTALS
Material:		
Freight:		
Tax:		
Fee / Fuel:		
Other Chrg: No		

Today Tons:	177.08	Loads:
Tons To Date:	14,810.34	7
Today Tonnes	160.64	
Tonnes To Date:	13,435.71	

Carrier : 8960583 QW TRUCKING LLC
Vehicle: QW7 QW7
License: AS9147
MaxGVW: 80,000

By acceptance of this ticket (with or without signature), driver accepts on behalf of themselves/their employer sole responsibility to ensure that the load received is within the weight limit authorized by law and shall holdseller harmless against any and all claims with respect to same CURB DELIVERY ONLY. NOT RESPONSIBLE FOR ANY DAMAGE BEYOND CURB.

Received:
Weighmaster: Colleen LeSage

Cust: _____

P/D Status: Deliver

Customer Copy Scale: 1



Plant: 32411

Berlin

368 New Brooklyn Road
Berlin, NJ 08009
856-809-0142

4/3/2017 07:25 In: 6:43:13
Customer: 8638404 THE AMBIENT GROUP LLC
Order : 950949 Camden, NJ. ABC Barrel Project
P.O. :

Tkt. No. 1006028263



Product 114203
Bank Run
S.O. Info: Camden, NJ
Ship Ref: 327 N. Front St

	Pounds	Kilo
Gross	73,060	33,139
Tare	25,120	11,394
Net	47,940	21,745
	23.97 Ton	21.75

	UNIT	TOTALS
Material:		
Freight:		
Tax:		
Fee / Fuel:		
Other Chrg: No		

Today Tons:	201.05	Loads:
Tons To Date:	14,834.31	8
Today Tonnes	182.39	
Tonnes To Date:	13,457.46	

Carrier : 8960583 QW TRUCKING LLC
Vehicle: QW11 AS569P
License:
MaxGVW: 80,000

By acceptance of this ticket (with or without signature), driver accepts on behalf of themselves/their employer sole responsibility to ensure that the load received is within the weight limit authorized by law and shall holdseller harmless against any and all claims with respect to same CURB DELIVERY ONLY. NOT RESPONSIBLE FOR ANY DAMAGE BEYOND CURB.

Received:
Weighmaster: Colleen LeSage

Cust: _____

P/D Status: Deliver

Customer Copy Scale: 1



Plant: 32411

Berlin

368 New Brooklyn Road
Berlin, NJ 08009
856-809-0142

4/3/2017 07:27 In: 6:43:43
Customer: 8638404 THE AMBIENT GROUP LLC
Order: 950949 Camden, NJ. ABC Barrel Project
P.O.:

Tkt. No. 1006028264



Product 114203
Bank Run
S.O. Info: Camden, NJ.
Ship Ref: 327 N. Front St

	Pounds	Kilo
Gross	78,300	35,516
Tare	29,280	13,281
Net	49,020	22,235
	24.51 Ton	22.24

	UNIT	TOTALS
Material:		
Freight:		
Tax:		
Fee / Fuel:		
Other Chrg: No		

Today Tons:	225.56	Loads:
Tons To Date:	14,858.82	9
Today Tonnes	204.62	
Tonnes To Date:	13,479.69	

By acceptance of this ticket (with or without signature), driver accepts on behalf of themselves/their employer sole responsibility to ensure that the load received is within the weight limit authorized by law and shall holdseller harmless against any and all claims with respect to same CURB DELIVERY ONLY. NOT RESPONSIBLE FOR ANY DAMAGE BEYOND CURB.

Carrier: 8960583 QW TRUCKING LLC
Vehicle: QW19 AS913T
License:
MaxGVW: 80,000

Received: *Colleen LeSage*
Weighmaster: Colleen LeSage
P/D Status: Deliver

Cust: _____

Customer Copy Scale: 1



Plant: 32411

Berlin

368 New Brooklyn Road
Berlin, NJ 08009
856-809-0142

4/3/2017 07:28 In: 6:44:03
Customer: 8638404 THE AMBIENT GROUP LLC
Order: 950949 Camden, NJ. ABC Barrel Project
P.O.:

Tkt. No. 1006028265



Product 114203
Bank Run
S.O. Info: Camden, NJ.
Ship Ref: 327 N. Front St

	Pounds	Kilo
Gross	79,100	35,879
Tare	28,160	12,773
Net	50,940	23,106
	25.47 Ton	23.11

	UNIT	TOTALS
Material:		
Freight:		
Tax:		
Fee / Fuel:		
Other Chrg: No		

Today Tons:	251.03	Loads:
Tons To Date:	14,884.29	10
Today Tonnes	227.73	
Tonnes To Date:	13,502.80	

By acceptance of this ticket (with or without signature), driver accepts on behalf of themselves/their employer sole responsibility to ensure that the load received is within the weight limit authorized by law and shall holdseller harmless against any and all claims with respect to same CURB DELIVERY ONLY. NOT RESPONSIBLE FOR ANY DAMAGE BEYOND CURB.

Carrier: 8040648 GJ SCOTT LLC
Vehicle: GS16 GS16
License: AT639K
MaxGVW: 80,000

Received: *Colleen LeSage*
Weighmaster: Colleen LeSage
P/D Status: Deliver

Cust: _____

Customer Copy Scale: 1



Plant: 32411

Berlin
368 New Brooklyn Road
Berlin, NJ 08009
856-809-0142

4/3/2017 07:30 In: 6:52:04
Customer: 8638404 THE AMBIENT GROUP LLC
Order: 950949 Camden, NJ. ABC Barrel Project
P.O.:

Tkt. No. 1006028266



Product 114203
Bank Run
S.O. Info: Camden, NJ.
Ship Ref: 327 N. Front St

	Pounds	Kilo
Gross	78,280	35,507
Tare	27,500	12,474
Net	50,780	23,033
	25.39 Ton	23.03

	UNIT	TOTALS
Material:		
Freight:		
Tax:		
Fee / Fuel:		
Other Chrg: No		

Today Tons:	276.42	Loads:	
Tons To Date:	14,909.68		11
Today Tonnes	250.76		
Tonnes To Date:	13,525.83		

Carrier: 8040648 GJ SCOTT LLC
Vehicle: GS9 GS9
License: AK587X
MaxGVW: 80,000
Received:
Weighmaster: Colleen LeSage

By acceptance of this ticket (with or without signature), driver accepts on behalf of themselves/their employer sole responsibility to ensure that the load received is within the weight limit authorized by law and shall hold seller harmless against any and all claims with respect to same
CURB DELIVERY ONLY. NOT RESPONSIBLE FOR ANY DAMAGE BEYOND CURB.

Cust: _____

P/D Status: Deliver

Customer Do Not Accept [1] Scale: 1



Plant: 32411

Berlin
368 New Brooklyn Road
Berlin, NJ 08009
856-809-0142

4/3/2017 07:32 In: 6:48:42
Customer: 8638404 THE AMBIENT GROUP LLC
Order: 950949 Camden, NJ. ABC Barrel Project
P.O.:

Tkt. No. 1006028267



Product 114203
Bank Run
S.O. Info: Camden, NJ.
Ship Ref: 327 N. Front St

	Pounds	Kilo
Gross	77,700	35,244
Tare	23,520	10,668
Net	54,180	24,576
	27.09 Ton	24.58

	UNIT	TOTALS
Material:		
Freight:		
Tax:		
Fee / Fuel:		
Other Chrg: No		

Today Tons:	303.51	Loads:	
Tons To Date:	14,936.77		12
Today Tonnes	275.34		
Tonnes To Date:	13,550.41		

Carrier: 9285292 BLUESTONE CONTRACTING C
Vehicle: SB11 XDLX86
License: XDUX86
MaxGVW: 80,000
Received:
Weighmaster: Colleen LeSage

By acceptance of this ticket (with or without signature), driver accepts on behalf of themselves/their employer sole responsibility to ensure that the load received is within the weight limit authorized by law and shall hold seller harmless against any and all claims with respect to same
CURB DELIVERY ONLY. NOT RESPONSIBLE FOR ANY DAMAGE BEYOND CURB.

Cust: _____

P/D Status: Deliver

Customer Copy Scale: 1



Plant: 32411

Berlin

368 New Brooklyn Road
Berlin, NJ 08009
856-809-0142

4/3/2017 08:42 In :
Customer: 8638404 THE AMBIENT GROUP LLC
Order : 950949 Camden, NJ. ABC Barrel Project
P.O. :

Tkt. No. 1006028273

Product 114203
Bank Run
S.O. Info: Camden, NJ.
Ship Ref: 327 N. Front St



	Pounds	Kilo
Gross	79,740	36,169
Tare	28,700 *	13,018
Net	51,040	23,151

25.52 Ton 23.15
* Predetermined Tare

	UNIT	TOTALS
Material:		
Freight:		
Tax:		
Fee / Fuel:		
Other Chrg: No		

Today Tons:	329.03	Loads:
Tons To Date:	14,962.29	13
Today Tonnes	298.49	
Tonnes To Date:	13,573.56	

By acceptance of this ticket (with or without signature), driver accepts on behalf of themselves/their employer sole responsibility to ensure that the load received is within the weight limit authorized by law and shall hold seller harmless against any and all claims with respect to same. CURB DELIVERY ONLY. NOT RESPONSIBLE FOR ANY DAMAGE BEYOND CURB.

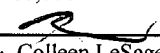
Carrier : 8040648 GJ SCOTT LLC
Vehicle: GS15 GS15
License: AS672T
MaxGVW: 80,000
Received: 
Weighmaster: Colleen LeSage

Cust: _____

P/D Status: Deliver

Customer Copy

Scale: 1



Plant: 32411

Berlin

368 New Brooklyn Road
Berlin, NJ 08009
856-809-0142

4/3/2017 08:48 In :
Customer: 8638404 THE AMBIENT GROUP LLC
Order : 950949 Camden, NJ. ABC Barrel Project
P.O. :

Tkt. No. 1006028274

Product 114203
Bank Run
S.O. Info: Camden, NJ.
Ship Ref: 327 N. Front St



	Pounds	Kilo
Gross	76,900	34,881
Tare	27,100 *	12,292
Net	49,800	22,589

24.90 Ton 22.59
* Predetermined Tare

	UNIT	TOTALS
Material:		
Freight:		
Tax:		
Fee / Fuel:		
Other Chrg: No		

Today Tons:	353.93	Loads:
Tons To Date:	14,987.19	14
Today Tonnes	321.08	
Tonnes To Date:	13,596.15	

By acceptance of this ticket (with or without signature), driver accepts on behalf of themselves/their employer sole responsibility to ensure that the load received is within the weight limit authorized by law and shall hold seller harmless against any and all claims with respect to same. CURB DELIVERY ONLY. NOT RESPONSIBLE FOR ANY DAMAGE BEYOND CURB.

Carrier : 8040648 GJ SCOTT LLC
Vehicle: GS6 GS6
License: AK761C
MaxGVW: 80,000
Received: 
Weighmaster: Colleen LeSage

Cust: _____

P/D Status: Deliver

Customer Do Not Accept [1]

Scale: 1



Plant: 32411

Berlin

368 New Brooklyn Road
Berlin, NJ 08009
856-809-0142

4/3/2017 08:49 In :
Customer: 8638404 THE AMBIENT GROUP LLC
Order : 950949 Camden, NJ. ABC Barrel Project
P.O. :

Tkt. No. 1006028275

Product 114203
Bank Run
S.O. Info: Camden, NJ.
Ship Ref: 327 N. Front St



	Pounds	Kilo
Gross	79,460	36,042
Tare	28,260 *	12,819
Net	51,200	23,224

25.60 Ton 23.22
* Predetermined Tare

	UNIT	TOTALS
Material:		
Freight:		
Tax:		
Fee / Fuel:		
Other Chrg: No		

Today Tons:	379.53	Loads:
Tons To Date:	15,012.79	15
Today Tonnes	344.30	
Tonnes To Date:	13,619.37	

Carrier : 8040648 GJ SCOTT LLC
Vehicle: GS17 GS17
License: AT640K
MaxGVW: 80,000

By acceptance of this ticket (with or without signature), driver accepts on behalf of themselves/their employer sole responsibility to ensure that the load received is within the weight limit authorized by law and shall hold seller harmless against any and all claims with respect to same CURB DELIVERY ONLY. NOT RESPONSIBLE FOR ANY DAMAGE BEYOND CURB.

Received: _____
Weighmaster: Colleen LeSage

Cust: _____

P/D Status: Deliver

Customer Copy

Scale: 1



Plant: 32411

Berlin

368 New Brooklyn Road
Berlin, NJ 08009
856-809-0142

4/3/2017 09:00 In :
Customer: 8638404 THE AMBIENT GROUP LLC
Order : 950949 Camden, NJ. ABC Barrel Project
P.O. :

Tkt. No. 1006028276

Product 114203
Bank Run
S.O. Info: Camden, NJ.
Ship Ref: 327 N. Front St



	Pounds	Kilo
Gross	77,820	35,299
Tare	24,760 *	11,231
Net	53,060	24,068

26.53 Ton 24.07
* Predetermined Tare

	UNIT	TOTALS
Material:		
Freight:		
Tax:		
Fee / Fuel:		
Other Chrg: No		

Today Tons:	406.06	Loads:
Tons To Date:	15,039.32	16
Today Tonnes	368.37	
Tonnes To Date:	13,643.44	

Carrier : 9070401 EAZY TRUCKING LLC
Vehicle: EAZY AS757R
License: AS757R
MaxGVW: 80,000

By acceptance of this ticket (with or without signature), driver accepts on behalf of themselves/their employer sole responsibility to ensure that the load received is within the weight limit authorized by law and shall hold seller harmless against any and all claims with respect to same CURB DELIVERY ONLY. NOT RESPONSIBLE FOR ANY DAMAGE BEYOND CURB.

Received: _____
Weighmaster: Colleen LeSage

Cust: _____

P/D Status: Deliver

Customer Copy

Scale: 1



Plant: 32411

Berlin

368 New Brooklyn Road
Berlin, NJ 08009 -
856-809-0142,

4/3/2017 09:01

In :

Customer: 8638404 THE AMBIENT GROUP LLC

Order : 950949 Camden, NJ. ABC Barrel Project

P.O. :

Tkt. No. 1006028277

Product 114203



Bank Run

S.O. Info: Camden, NJ.

Ship Ref: 327 N. Front St

	Pounds	Kilo
Gross	79,240	35,943
Tare	28,780 *	13,054
Net	50,460	22,888

25.23 Ton 22.89

* Predetermined Tare

Today Tons:	431.29	Loads:
Tons To Date:	15,064.55	17
Today Tonnes	391.26	
Tonnes To Date:	13,666.33	

	UNIT	TOTALS
Material:		
Freight:		
Tax:		
Fee / Fuel:		
Other Chrg: No		

Carrier : 8040648 GJ SCOTT LLC

Vehicle: GS14 GS14

License: As672T

MaxGVW: 80,000

Received:

Weighmaster: Colleen LeSage

Cust: _____

P/D Status: Deliver

Customer Do Not Accept [1] Scale: 1

By acceptance of this ticket (with or without signature), driver accepts on behalf of themselves/their employer sole responsibility to ensure that the load received is within the weight limit authorized by law and shall hold seller harmless against any and all claims with respect to same CURB DELIVERY ONLY. NOT RESPONSIBLE FOR ANY DAMAGE BEYOND CURB.



Plant: 32411

Berlin

368 New Brooklyn Road
Berlin, NJ 08009
856-809-0142.

4/3/2017 09:04

In :

Customer: 8638404 THE AMBIENT GROUP LLC

Order : 950949 Camden, NJ. ABC Barrel Project

P.O. :

Tkt. No. 1006028278

Product 114203



Bank Run

S.O. Info: Camden, NJ.

Ship Ref: 327 N. Front St

	Pounds	Kilo
Gross	78,760	35,725
Tare	28,140 *	12,764
Net	50,620	22,961

25.31 Ton 22.96

* Predetermined Tare

Today Tons:	456.60	Loads:
Tons To Date:	15,089.86	18
Today Tonnes	414.22	
Tonnes To Date:	13,689.29	

	UNIT	TOTALS
Material:		
Freight:		
Tax:		
Fee / Fuel:		
Other Chrg: No		

Carrier : 9249110 CLM CONTRACTING LLC

Vehicle: CLM6 CLM6

License: AT597T

MaxGVW: 80,000

Received:

Weighmaster: Colleen LeSage

Cust: _____

P/D Status: Deliver

Customer Copy Scale: 1

By acceptance of this ticket (with or without signature), driver accepts on behalf of themselves/their employer sole responsibility to ensure that the load received is within the weight limit authorized by law and shall hold seller harmless against any and all claims with respect to same CURB DELIVERY ONLY. NOT RESPONSIBLE FOR ANY DAMAGE BEYOND CURB.



Plant: 32411

Berlin

368 New Brooklyn Road
Berlin, NJ 08009
856-809-0142

4/3/2017 09:07 In :
Customer: 8638404 THE AMBIENT GROUP LLC
Order : 950949 Camden, NJ. ABC Barrel Project
P.O. :

Tkt. No. 1006028280



Product 114203
Bank Run
S.O. Info: Camden, NJ.
Ship Ref: 327 N. Front St

	Pounds	Kilo
Gross	79,240	35,943
Tare	28,160 *	12,773
Net	51,080	23,169

25.54 Ton 23.17
* Predetermined Tare

	UNIT	TOTALS
Material:		
Freight:		
Tax:		
Fee / Fuel:		
Other Chrg: No		

Today Tons:	482.14	Loads:
Tons To Date:	15,115.40	19
Today Tonnes	437.39	
Tonnes To Date:	13,712.46	

By acceptance of this ticket (with or without signature), driver accepts on behalf of themselves/their employer sole responsibility to ensure that the load received is within the weight limit authorized by law and shall hold seller harmless against any and all claims with respect to same CURB DELIVERY ONLY. NOT RESPONSIBLE FOR ANY DAMAGE BEYOND CURB.

Carrier : 8040648 GJ SCOTT LLC
Vehicle: GS16 GS16
License: AT639K
MaxGVW: 80,000

Received: _____
Weighmaster: Colleen LeSage

Cust: _____

P/D Status: Deliver

Customer Copy

Scale: 1



Plant: 32411

Berlin

368 New Brooklyn Road
Berlin, NJ 08009
856-809-0142

4/3/2017 09:11 In :
Customer: 8638404 THE AMBIENT GROUP LLC
Order : 950949 Camden, NJ. ABC Barrel Project
P.O. :

Tkt. No. 1006028281



Product 114203
Bank Run
S.O. Info: Camden, NJ.
Ship Ref: 327 N. Front St

	Pounds	Kilo
Gross	78,320	35,525
Tare	27,500 *	12,474
Net	50,820	23,052

25.41 Ton 23.05
* Predetermined Tare

	UNIT	TOTALS
Material:		
Freight:		
Tax:		
Fee / Fuel:		
Other Chrg: No		

Today Tons:	507.55	Loads:
Tons To Date:	15,140.81	20
Today Tonnes	460.44	
Tonnes To Date:	13,735.51	

By acceptance of this ticket (with or without signature), driver accepts on behalf of themselves/their employer sole responsibility to ensure that the load received is within the weight limit authorized by law and shall hold seller harmless against any and all claims with respect to same CURB DELIVERY ONLY. NOT RESPONSIBLE FOR ANY DAMAGE BEYOND CURB.

Carrier : 8040648 GJ SCOTT LLC
Vehicle: GS9 GS9
License: AK587X
MaxGVW: 80,000

Received: _____
Weighmaster: Colleen LeSage

Cust: _____

P/D Status: Deliver

Customer Copy

Scale: 1



Plant: 32411

Berlin
368 New Brooklyn Road
Berlin, NJ 08009
856-809-0142

4/3/2017 09:34 In :
Customer: 8638404 THE AMBIENT GROUP LLC
Order : 950949 Camden, NJ. ABC Barrel Project
P.O. :

Tkt. No. 1006028282



Product 114203
Bank Run
S.O. Info: Camden, NJ.
Ship Ref: 327 N. Front St

	Pounds	Kilo
Gross	78,880	35,779
Tare	28,040 *	12,719
Net	50,840	23,061

25.42 Ton 23.06
* Predetermined Tare

	UNIT	TOTALS
Material:		
Freight:		
Tax:		
Fee / Fuel:		
Other Chrg: <u>No</u>		

Today Tons:	532.97	Loads:
Tons To Date:	15,166.23	21
Today Tonnes	483.50	
Tonnes To Date:	13,758.57	

Carrier : 8960583 QW TRUCKING LLC
Vehicle: QW7 QW7
License: AS914T
MaxGVW: 80,000

By acceptance of this ticket (with or without signature), driver accepts on behalf of themselves/their employer sole responsibility to ensure that the load received is within the weight limit authorized by law and shall hold seller harmless against any and all claims with respect to same CURB DELIVERY ONLY. NOT RESPONSIBLE FOR ANY DAMAGE BEYOND CURB.

Received:
Weighmaster: Colleen LeSage

Cust: _____

P/D Status: Deliver

Customer Do Not Accept [2] Scale: 1



Plant: 32411

Berlin
368 New Brooklyn Road
Berlin, NJ 08009
856-809-0142

4/3/2017 09:36 In :
Customer: 8638404 THE AMBIENT GROUP LLC
Order : 950949 Camden, NJ. ABC Barrel Project
P.O. :

Tkt. No. 1006028283



Product 114203
Bank Run
S.O. Info: Camden, NJ.
Ship Ref: 327 N. Front St

	Pounds	Kilo
Gross	77,400	35,108
Tare	23,520 *	10,668
Net	53,880	24,440

26.94 Ton 24.44
* Predetermined Tare

	UNIT	TOTALS
Material:		
Freight:		
Tax:		
Fee / Fuel:		
Other Chrg: <u>No</u>		

Today Tons:	559.91	Loads:
Tons To Date:	15,193.17	22
Today Tonnes	507.94	
Tonnes To Date:	13,783.01	

Carrier : 9285292 BLUESTONE CONTRACTING C
Vehicle: SB11 XDUX86
License: XDUX86
MaxGVW: 80,000

By acceptance of this ticket (with or without signature), driver accepts on behalf of themselves/their employer sole responsibility to ensure that the load received is within the weight limit authorized by law and shall hold seller harmless against any and all claims with respect to same CURB DELIVERY ONLY. NOT RESPONSIBLE FOR ANY DAMAGE BEYOND CURB.

Received:
Weighmaster: Colleen LeSage

Cust: _____

P/D Status: Deliver

Customer Copy Scale: 1



Plant: 32411

Berlin

368 New Brooklyn Road
Berlin, NJ 08009
856-809-0142

4/3/2017 09:39 In:
Customer: 8638404 THE AMBIENT GROUP LLC
Order : 950949 Camden, NJ. ABC Barrel Project
P.O. :

Tkt. No. 1006028284

Product 114203
Bank Run
S.O. Info: Camden, NJ.
Ship Ref: 327 N. Front St



	Pounds	Kilo
Gross	73,000	33,112
Tare	25,120 *	11,394
Net	47,880	21,718

23.94 Ton 21.72

* Predetermined Tare

	UNIT	TOTALS
Material:		
Freight:		
Tax:		
Fee / Fuel:		
Other Chrg:	No	

Today Tons:	583.85	Loads:
Tons To Date:	15,217.11	23
Today Tonnes	529.66	
Tonnes To Date:	13,804.73	

By acceptance of this ticket (with or without signature), driver accepts on behalf of themselves/their employer sole responsibility to ensure that the load received is within the weight limit authorized by law and shall hold seller harmless against any and all claims with respect to same CURB DELIVERY ONLY. NOT RESPONSIBLE FOR ANY DAMAGE BEYOND CURB.

Carrier : 8960583 QW TRUCKING LLC
Vehicle: QW11 AS569P
License:
MaxGVW: 80,000
Received: *[Signature]*
Weighmaster: Colleen LeSage

Cust: *[Signature]*

P/D Status: Deliver

Customer Copy

Scale: 1



Plant: 32411

Berlin

368 New Brooklyn Road
Berlin, NJ 08009
856-809-0142

4/3/2017 09:41 In:
Customer: 8638404 THE AMBIENT GROUP LLC
Order : 950949 Camden, NJ. ABC Barrel Project
P.O. :

Tkt. No. 1006028285

Product 114203
Bank Run
S.O. Info: Camden, NJ.
Ship Ref: 327 N. Front St



	Pounds	Kilo
Gross	77,240	35,035
Tare	29,280 *	13,281
Net	47,960	21,754

23.98 Ton 21.75

* Predetermined Tare

	UNIT	TOTALS
Material:		
Freight:		
Tax:		
Fee / Fuel:		
Other Chrg:	No	

Today Tons:	607.83	Loads:
Tons To Date:	15,241.09	24
Today Tonnes	551.41	
Tonnes To Date:	13,826.48	

By acceptance of this ticket (with or without signature), driver accepts on behalf of themselves/their employer sole responsibility to ensure that the load received is within the weight limit authorized by law and shall hold seller harmless against any and all claims with respect to same CURB DELIVERY ONLY. NOT RESPONSIBLE FOR ANY DAMAGE BEYOND CURB.

Carrier : 8960583 QW TRUCKING LLC
Vehicle: QW19 AS913T
License:
MaxGVW: 80,000
Received: *[Signature]*
Weighmaster: Colleen LeSage

Cust: _____

P/D Status: Deliver

Customer Copy

Scale: 1



Plant: 32411

Berlin

368 New Brooklyn Road
Berlin, NJ 08009
856-809-0142

4/3/2017 10:01 In:
Customer: 8638404 THE AMBIENT GROUP LLC
Order : 950949 Camden, NJ. ABC Barrel Project
P.O. :

Tkt. No. 1006028286

Product 114203
Bank Run
S.O. Info: Camden, NJ.
Ship Ref: 327 N. Front St



	Pounds	Kilo
Gross	78,220	35,480
Tare	28,700 *	13,018
Net	49,520	22,462

24.76 Ton 22.46

* Predetermined Tare

	UNIT	TOTALS
Material:		
Freight:		
Tax:		
Fee / Fuel:		
Other Chrg:	No	

Today Tons:	632.59	Loads:
Tons To Date:	15,265.85	25
Today Tonnes	573.88	
Tonnes To Date:	13,848.95	

By acceptance of this ticket (with or without signature), driver accepts on behalf of themselves/their employer sole responsibility to ensure that the load received is within the weight limit authorized by law and shall hold seller harmless against any and all claims with respect to same CURB DELIVERY ONLY .NOT RESPONSIBLE FOR ANY DAMAGE BEYOND CURB.

Carrier : 8040648 GJ SCOTT LLC
Vehicle: GS15 GS15
License: AS672T
MaxGVW: 80,000
Received: [Signature]
Weighmaster: Colleen LeSage

Cust: _____

P/D Status: Deliver

Customer Copy

Scale: 1



Plant: 32411

Berlin

368 New Brooklyn Road
Berlin, NJ 08009
856-809-0142

4/3/2017 10:06 In:
Customer: 8638404 THE AMBIENT GROUP LLC
Order : 950949 Camden, NJ. ABC Barrel Project
P.O. :

Tkt. No. 1006028287

Product 114203
Bank Run
S.O. Info: Camden, NJ.
Ship Ref: 327 N. Front St



	Pounds	Kilo
Gross	76,300	34,609
Tare	28,260 *	12,819
Net	48,040	21,791

24.02 Ton 21.79

* Predetermined Tare

	UNIT	TOTALS
Material:		
Freight:		
Tax:		
Fee / Fuel:		
Other Chrg:	No	

Today Tons:	656.61	Loads:
Tons To Date:	15,289.87	26
Today Tonnes	595.67	
Tonnes To Date:	13,870.74	

By acceptance of this ticket (with or without signature), driver accepts on behalf of themselves/their employer sole responsibility to ensure that the load received is within the weight limit authorized by law and shall hold seller harmless against any and all claims with respect to same CURB DELIVERY ONLY .NOT RESPONSIBLE FOR ANY DAMAGE BEYOND CURB.

Carrier : 8040648 GJ SCOTT LLC
Vehicle: GS17 GS17
License: AT640K
MaxGVW: 80,000
Received: _____
Weighmaster: Colleen LeSage

Cust: _____

P/D Status: Deliver

Customer Copy

Scale: 1



Plant: 32411

Berlin

368 New Brooklyn Road
Berlin, NJ 08009
856-809-0142

4/3/2017 10:11

In :

Customer: 8638404 THE AMBIENT GROUP LLC

Order : 950949 Camden, NJ. ABC Barrel Project

P.O. :

Tkt. No. 1006028288

Product 114203



Bank Run

S.O. Info: Camden, NJ.

Ship Ref: 327 N. Front St

	Pounds	Kilo
Gross	76,720	34,800
Tare	27,100 *	12,292
Net	49,620	22,507

24.81 Ton 22.51

* Predetermined Tare

	UNIT	TOTALS
Material:		
Freight:		
Tax:		
Fee / Fuel:		
Other Chrg: No		

Today Tons:	681.42	Loads:
Tons To Date:	15,314.68	27
Today Tonnes	618.17	
Tonnes To Date:	13,893.24	

By acceptance of this ticket (with or without signature), driver accepts on behalf of themselves/their employer sole responsibility to ensure that the load received is within the weight limit authorized by law and shall hold seller harmless against any and all claims with respect to same
CURB DELIVERY ONLY. NOT RESPONSIBLE FOR ANY DAMAGE BEYOND CURB.

Carrier : 8040648 GJ SCOTT LLC

Vehicle: GS6 GS6

License: AK761C

MaxGVW: 80,000

Received:

Cust: _____

Weighmaster: Colleen LeSage

P/D Status: Deliver

Customer Do Not Accept [1] Scale: 1



Plant: 32411

Berlin

368 New Brooklyn Road
Berlin, NJ 08009
856-809-0142

4/3/2017 10:19

In :

Customer: 8638404 THE AMBIENT GROUP LLC

Order : 950949 Camden, NJ. ABC Barrel Project

P.O. :

Tkt. No. 1006028289

Product 114203



Bank Run

S.O. Info: Camden, NJ.

Ship Ref: 327 N. Front St

	Pounds	Kilo
Gross	76,360	34,636
Tare	28,780 *	13,054
Net	47,580	21,582

23.79 Ton 21.58

* Predetermined Tare

	UNIT	TOTALS
Material:		
Freight:		
Tax:		
Fee / Fuel:		
Other Chrg: No		

Today Tons:	705.21	Loads:
Tons To Date:	15,338.47	28
Today Tonnes	639.76	
Tonnes To Date:	13,914.83	

By acceptance of this ticket (with or without signature), driver accepts on behalf of themselves/their employer sole responsibility to ensure that the load received is within the weight limit authorized by law and shall hold seller harmless against any and all claims with respect to same
CURB DELIVERY ONLY. NOT RESPONSIBLE FOR ANY DAMAGE BEYOND CURB.

Carrier : 8040648 GJ SCOTT LLC

Vehicle: GS14 GS14

License: As672T

MaxGVW: 80,000

Received:

Cust: _____

Weighmaster: Colleen LeSage

P/D Status: Deliver

Customer Do Not Accept [1] Scale: 1



Plant: 32411

Berlin

368 New Brooklyn Road
Berlin, NJ 08009
856-809-0142

4/3/2017 10:29 In:
Customer: 8638404 THE AMBIENT GROUP LLC
Order : 950949 Camden, NJ. ABC Barrel Project
P.O. :

Tkt. No. 1006028290



Product 114203
Bank Run
S.O. Info: Camden, NJ.
Ship Ref: 327 N. Front St

	Pounds	Kilo
Gross	76,680	34,781
Tare	28,160 *	12,773
Net	48,520	22,008

24.26 Ton 22.01

* Predetermined Tare

	UNIT	TOTALS
Material:		
Freight:		
Tax:		
Fee / Fuel:		
Other Chrg: No		

Today Tons:	729.47	Loads:
Tons To Date:	15,362.73	29
Today Tonnes	661.76	
Tonnes To Date:	13,936.83	

Carrier : 8040648 GJ SCOTT LLC
Vehicle: GS16 GS16
License: AT639K
MaxGVW: 80,000

By acceptance of this ticket (with or without signature), driver accepts on behalf of themselves/their employer sole responsibility to ensure that the load received is within the weight limit authorized by law and shall holdseller harmless against any and all claims with respect to same CURB DELIVERY ONLY. NOT RESPONSIBLE FOR ANY DAMAGE BEYOND CURB.

Received: 
Weighmaster: Colleen LeSage

Cust: _____

P/D Status: Deliver

Customer Copy

Scale: 1



Plant: 32411

Berlin

368 New Brooklyn Road
Berlin, NJ 08009
856-809-0142

4/3/2017 10:33 In:
Customer: 8638404 THE AMBIENT GROUP LLC
Order : 950949 Camden, NJ. ABC Barrel Project
P.O. :

Tkt. No. 1006028291



Product 114203
Bank Run
S.O. Info: Camden, NJ.
Ship Ref: 327 N. Front St

	Pounds	Kilo
Gross	76,820	34,845
Tare	24,760 *	11,231
Net	52,060	23,614

26.03 Ton 23.61

* Predetermined Tare

	UNIT	TOTALS
Material:		
Freight:		
Tax:		
Fee / Fuel:		
Other Chrg: No		

Today Tons:	755.50	Loads:
Tons To Date:	15,388.76	30
Today Tonnes	685.38	
Tonnes To Date:	13,960.45	

Carrier : 9070401 EAZY TRUCKING LLC
Vehicle: EAZY AS757R
License: AS757R
MaxGVW: 80,000

By acceptance of this ticket (with or without signature), driver accepts on behalf of themselves/their employer sole responsibility to ensure that the load received is within the weight limit authorized by law and shall holdseller harmless against any and all claims with respect to same CURB DELIVERY ONLY. NOT RESPONSIBLE FOR ANY DAMAGE BEYOND CURB.

Received: 
Weighmaster: Colleen LeSage

Cust: _____

P/D Status: Deliver

Customer Copy

Scale: 1



Plant: 32411

Berlin

368 New Brooklyn Road
Berlin, NJ 08009
856-809-0142

4/3/2017 10:35 In:
Customer: 8638404 THE AMBIENT GROUP LLC
Order : 950949 Camden, NJ. ABC Barrel Project
P.O. :

Tkt. No. 1006028292

Product 114203
Bank Run
S.O. Info: Camden, NJ.
Ship Ref: 327 N. Front St



	Pounds	Kilo
Gross	76,480	34,691
Tare	27,500 *	12,474
Net	48,980	22,217

24.49 Ton 22.22

* Predetermined Tare

	UNIT	TOTALS
Material:		
Freight:		
Tax:		
Fee / Fuel:		
Other Chrg: No		

Today Tons:	779.99	Loads:
Tons To Date:	15,413.25	31
Today Tonnes	707.59	
Tonnes To Date:	13,982.67	

Carrier : 8040648 GJ SCOTT LLC
Vehicle: GS9 GS9
License: AK587X
MaxGVW: 80,000

By acceptance of this ticket (with or without signature), driver accepts on behalf of themselves/their employer sole responsibility to ensure that the load received is within the weight limit authorized by law and shall hold seller harmless against any and all claims with respect to same CURB DELIVERY ONLY. NOT RESPONSIBLE FOR ANY DAMAGE BEYOND CURB.

Received:
Weighmaster: Colleen LeSage

Cust: _____

P/D Status: Deliver

Customer Copy

Scale: 1



Plant: 32411

Berlin

368 New Brooklyn Road
Berlin, NJ 08009
856-809-0142

4/3/2017 11:15 In:
Customer: 8638404 THE AMBIENT GROUP LLC
Order : 950949 Camden, NJ. ABC Barrel Project
P.O. :

Tkt. No. 1006028294

Product 114203
Bank Run
S.O. Info: Camden, NJ.
Ship Ref: 327 N. Front St



	Pounds	Kilo
Gross	72,940	33,085
Tare	25,120 *	11,394
Net	47,820	21,691

23.91 Ton 21.69

* Predetermined Tare

	UNIT	TOTALS
Material:		
Freight:		
Tax:		
Fee / Fuel:		
Other Chrg: No		

Today Tons:	803.90	Loads:
Tons To Date:	15,437.16	32
Today Tonnes	729.29	
Tonnes To Date:	14,004.36	

Carrier : 8960583 QW TRUCKING LLC
Vehicle: QW11 AS569P
License:
MaxGVW: 80,000

By acceptance of this ticket (with or without signature), driver accepts on behalf of themselves/their employer sole responsibility to ensure that the load received is within the weight limit authorized by law and shall hold seller harmless against any and all claims with respect to same CURB DELIVERY ONLY. NOT RESPONSIBLE FOR ANY DAMAGE BEYOND CURB.

Received:
Weighmaster: Colleen LeSage

Cust: _____

P/D Status: Deliver

Customer Copy

Scale: 1



Plant: 32411

Berlin

368 New Brooklyn Road
Berlin, NJ 08009
856-809-0142

4/3/2017 11:16 In :
Customer: 8638404 THE AMBIENT GROUP LLC
Order : 950949 Camden, NJ. ABC Barrel Project
P.O. :

Tkt. No. 1006028295



Product 114203
Bank Run
S.O. Info: Camden, NJ.
Ship Ref: 327 N. Front St

	Pounds	Kilo
Gross	76,300	34,609
Tare	23,520 *	10,668
Net	52,780	23,941

26.39 Ton 23.94

* Predetermined Tare

	UNIT	TOTALS
Material:		
Freight:		
Tax:		
Fee / Fuel:		
Other Chrg:	No	

Today Tons:	830.29	Loads:
Tons To Date:	15,463.55	33
Today Tonnes	753.23	
Tonnes To Date:	14,028.30	

Carrier : 9285292 BLUESTONE CONTRACTING C
Vehicle: SB11 XDUX86
License: XDUX86
MaxGVW: 80,000

By acceptance of this ticket (with or without signature), driver accepts on behalf of themselves/their employer sole responsibility to ensure that the load received is within the weight limit authorized by law and shall hold seller harmless against any and all claims with respect to same CURB DELIVERY ONLY. NOT RESPONSIBLE FOR ANY DAMAGE BEYOND CURB.

Received: _____
Weighmaster: Colleen LeSage

Cust: _____

P/D Status: Deliver

Customer Copy

Scale: 1



Plant: 32411

Berlin

368 New Brooklyn Road
Berlin, NJ 08009
856-809-0142

4/3/2017 11:19 In :
Customer: 8638404 THE AMBIENT GROUP LLC
Order : 950949 Camden, NJ. ABC Barrel Project
P.O. :

Tkt. No. 1006028296



Product 114203
Bank Run
S.O. Info: Camden, NJ.
Ship Ref: 327 N. Front St

	Pounds	Kilo
Gross	79,140	35,897
Tare	28,700 *	13,018
Net	50,440	22,879

25.22 Ton 22.88

* Predetermined Tare

	UNIT	TOTALS
Material:		
Freight:		
Tax:		
Fee / Fuel:		
Other Chrg:	No	

Today Tons:	855.51	Loads:
Tons To Date:	15,488.77	34
Today Tonnes	776.11	
Tonnes To Date:	14,051.18	

Carrier : 8040648 GJ SCOTT LLC
Vehicle: GS15 GS15
License: AS672T
MaxGVW: 80,000

By acceptance of this ticket (with or without signature), driver accepts on behalf of themselves/their employer sole responsibility to ensure that the load received is within the weight limit authorized by law and shall hold seller harmless against any and all claims with respect to same CURB DELIVERY ONLY. NOT RESPONSIBLE FOR ANY DAMAGE BEYOND CURB.

Received: _____
Weighmaster: Colleen LeSage

Cust: _____

P/D Status: Deliver

Customer Copy

Scale: 1



Plant: 32411

Berlin

368 New Brooklyn Road
Berlin, NJ 08009
856-809-0142

4/3/2017 11:24 In :
Customer: 8638404 THE AMBIENT GROUP LLC
Order : 950949 Camden, NJ, ABC Barrel Project
P.O. :

Tkt. No. 1006028297

Product 114203
Bank Run
S.O. Info: Camden, NJ.
Ship Ref: 327 N. Front St



	Pounds	Kilo
Gross	77,160	34,999
Tare	28,260 *	12,819
Net	48,900	22,181

24.45 Ton 22.18

* Predetermined Tare

UNIT	TOTALS
Material:	
Freight:	
Tax:	
Fee / Fuel:	
Other Chrg: No	

Today Tons:	879.96	Loads:
Tons To Date:	15,513.22	35
Today Tonnes	798.29	
Tonnes To Date:	14,073.36	

Carrier : 8040648 GJ SCOTT LLC
Vehicle: GS17 GS17
License: AT640K
MaxGVW: 80,000

By acceptance of this ticket (with or without signature), driver accepts on behalf of themselves/their employer sole responsibility to ensure that the load received is within the weight limit authorized by law and shall holdseller harmless against any and all claims with respect to same CURB DELIVERY ONLY. NOT RESPONSIBLE FOR ANY DAMAGE BEYOND CURB.

Received: _____

Cust: _____

Weighmaster: Colleen LeSage

P/D Status: Deliver

Customer Copy

Scale: 1



Plant: 32411

Berlin

368 New Brooklyn Road
Berlin, NJ 08009
856-809-0142

4/3/2017 11:27 In :
Customer: 8638404 THE AMBIENT GROUP LLC
Order : 950949 Camden, NJ, ABC Barrel Project
P.O. :

Tkt. No. 1006028298

Product 114203
Bank Run
S.O. Info: Camden, NJ.
Ship Ref: 327 N. Front St



	Pounds	Kilo
Gross	77,980	35,371
Tare	28,040 *	12,719
Net	49,940	22,652

24.97 Ton 22.65

* Predetermined Tare

UNIT	TOTALS
Material:	
Freight:	
Tax:	
Fee / Fuel:	
Other Chrg: No	

Today Tons:	904.93	Loads:
Tons To Date:	15,538.19	36
Today Tonnes	820.94	
Tonnes To Date:	14,096.01	

Carrier : 8960583 QW TRUCKING LLC
Vehicle: QW7 QW7
License: AS914T
MaxGVW: 80,000

By acceptance of this ticket (with or without signature), driver accepts on behalf of themselves/their employer sole responsibility to ensure that the load received is within the weight limit authorized by law and shall holdseller harmless against any and all claims with respect to same CURB DELIVERY ONLY. NOT RESPONSIBLE FOR ANY DAMAGE BEYOND CURB.

Received: _____

Cust: _____

Weighmaster: Colleen LeSage

P/D Status: Deliver

Customer Copy

Scale: 1



Plant: 32411

Berlin

368 New Brooklyn Road
Berlin, NJ 08009
856-809-0142

4/3/2017 11:31 In:
Customer: 8638404 THE AMBIENT GROUP LLC
Order : 950949 Camden, NJ. ABC Barrel Project
P.O. :

Tkt. No. 1006028299

Product 114203
Bank Run
S.O. Info: Camden, NJ.
Ship Ref: 327 N. Front St



	Pounds	Kilo
Gross	77,900	35,335
Tare	27,100 *	12,292
Net	50,800	23,042

25.40 Ton 23.04

* Predetermined Tare

	UNIT	TOTALS
Material:		
Freight:		
Tax:		
Fee / Fuel:		
Other Chrg: No		

Today Tons:	930.33	Loads:
Tons To Date:	15,563.59	37
Today Tonnes	843.98	
Tonnes To Date:	14,119.05	

Carrier : 8040648 GJ SCOTT LLC

Vehicle: GS6 GS6

License: AK761C

MaxGVW: 80,000

Received: 

Weighmaster: Colleen LeSage

By acceptance of this ticket (with or without signature), driver accepts on behalf of themselves/their employer sole responsibility to ensure that the load received is within the weight limit authorized by law and shall holdseller harmless against any and all claims with respect to same CURB DELIVERY ONLY. NOT RESPONSIBLE FOR ANY DAMAGE BEYOND CURB.

Cust: _____

P/D Status: Deliver

Customer Copy

Scale: 1



Plant: 32411

Berlin

368 New Brooklyn Road
Berlin, NJ 08009
856-809-0142

4/3/2017 11:37 In:
Customer: 8638404 THE AMBIENT GROUP LLC
Order : 950949 Camden, NJ. ABC Barrel Project
P.O. :

Tkt. No. 1006028300

Product 114203
Bank Run
S.O. Info: Camden, NJ.
Ship Ref: 327 N. Front St



	Pounds	Kilo
Gross	79,960	36,269
Tare	29,280 *	13,281
Net	50,680	22,988

25.34 Ton 22.99

* Predetermined Tare

	UNIT	TOTALS
Material:		
Freight:		
Tax:		
Fee / Fuel:		
Other Chrg: No		

Today Tons:	955.67	Loads:
Tons To Date:	15,588.93	38
Today Tonnes	866.97	
Tonnes To Date:	14,142.04	

Carrier : 8960583 QW TRUCKING LLC

Vehicle: QW19 AS913T

License:

MaxGVW: 80,000

Received: 

Weighmaster: Colleen LeSage

By acceptance of this ticket (with or without signature), driver accepts on behalf of themselves/their employer sole responsibility to ensure that the load received is within the weight limit authorized by law and shall holdseller harmless against any and all claims with respect to same CURB DELIVERY ONLY. NOT RESPONSIBLE FOR ANY DAMAGE BEYOND CURB.

Cust: _____

P/D Status: Deliver

Customer Copy

Scale: 1



Plant: 32411

Berlin

368 New Brooklyn Road
Berlin, NJ 08009
856-809-0142

4/3/2017 11:40 In:
Customer: 8638404 THE AMBIENT GROUP LLC
Order : 950949 Camden, NJ. ABC Barrel Project
P.O. :

Tkt. No. 1006028301

Product 114203
Bank Run
S.O. Info: Camden, NJ.
Ship Ref: 327 N. Front St



	Pounds	Kilo
Gross	77,320	35,072
Tare	28,780 *	13,054
Net	48,540	22,017

24.27 Ton 22.02

* Predetermined Tare

	UNIT	TOTALS
Material:		
Freight:		
Tax:		
Fee / Fuel:		
Other Chrg: No		

Today Tons:	979.94	Loads:
Tons To Date:	15,613.20	39
Today Tonnes	888.99	
Tonnes To Date:	14,164.06	

Carrier : 8040648 GJ SCOTT LLC
Vehicle: GS14 GS14
License: As672T
MaxGVW: 80,000

By acceptance of this ticket (with or without signature), driver accepts on behalf of themselves/their employer sole responsibility to ensure that the load received is within the weight limit authorized by law and shall hold seller harmless against any and all claims with respect to same CURB DELIVERY ONLY. NOT RESPONSIBLE FOR ANY DAMAGE BEYOND CURB.

Received:
Weighmaster: Colleen LeSage

Cust: _____

P/D Status: Deliver

Customer Copy

Scale: 1



Plant: 32411

Berlin

368 New Brooklyn Road
Berlin, NJ 08009
856-809-0142

4/3/2017 11:47 In:
Customer: 8638404 THE AMBIENT GROUP LLC
Order : 950949 Camden, NJ. ABC Barrel Project
P.O. :

Tkt. No. 1006028302

Product 114203
Bank Run
S.O. Info: Camden, NJ.
Ship Ref: 327 N. Front St



	Pounds	Kilo
Gross	77,760	35,271
Tare	28,160 *	12,773
Net	49,600	22,498

24.80 Ton 22.50

* Predetermined Tare

	UNIT	TOTALS
Material:		
Freight:		
Tax:		
Fee / Fuel:		
Other Chrg: No		

Today Tons:	1,004.74	Loads:
Tons To Date:	15,638.00	40
Today Tonnes	911.48	
Tonnes To Date:	14,186.55	

By acceptance of this ticket (with or without signature), driver accepts on behalf of themselves/their employer sole responsibility to ensure that the load received is within the weight limit authorized by law and shall hold seller harmless against any and all claims with respect to same CURB DELIVERY ONLY. NOT RESPONSIBLE FOR ANY DAMAGE BEYOND CURB.

Carrier : 8040648 GJ SCOTT LLC
Vehicle: GS16 GS16
License: AT639K
MaxGVW: 80,000

Received:
Weighmaster: Colleen LeSage

Cust: _____

P/D Status: Deliver

Customer Copy

Scale: 1



Plant: 32411

Berlin
368 New Brooklyn Road
Berlin, NJ 08009
856-809-0142

4/3/2017 12:18 In:
Customer: 8638404 THE AMBIENT GROUP LLC
Order : 950949 Camden, NJ. ABC Barrel Project
P.O. :

Tkt. No. 1006028304

Product 114203
Bank Run
S.O. Info: Camden, NJ.
Ship Ref: 327 N. Front St



	Pounds	Kilo
Gross	78,140	35,444
Tare	27,500 *	12,474
Net	50,640	22,970

25.32 Ton 22.97
* Predetermined Tare

UNIT	TOTALS
Material:	
Freight:	
Tax:	
Fee / Fuel:	
Other Chrg: No	

Today Tons:	1,030.06	Loads:
Tons To Date:	15,663.32	41
Today Tonnes	934.45	
Tonnes To Date:	14,209.52	

Carrier : 8040648 GJ SCOTT LLC
Vehicle: GS9 GS9
License: AK587X
MaxGVW: 80,000
Received:
Weighmaster: Colleen LeSage

By acceptance of this ticket (with or without signature), driver accepts on behalf of themselves/their employer sole responsibility to ensure that the load received is within the weight limit authorized by law and shall hold harmless against any and all claims with respect to same CURB DELIVERY ONLY. NOT RESPONSIBLE FOR ANY DAMAGE BEYOND CURB.

Cust:

P/D Status: Deliver

Customer Copy Scale: 1



Plant: 32411

Berlin
368 New Brooklyn Road
Berlin, NJ 08009
856-809-0142

4/3/2017 12:23 In:
Customer: 8638404 THE AMBIENT GROUP LLC
Order : 950949 Camden, NJ. ABC Barrel Project
P.O. :

Tkt. No. 1006028305

Product 114203
Bank Run
S.O. Info: Camden, NJ.
Ship Ref: 327 N. Front St



	Pounds	Kilo
Gross	79,040	35,852
Tare	24,760 *	11,231
Net	54,280	24,621

27.14 Ton 24.62
* Predetermined Tare

UNIT	TOTALS
Material:	
Freight:	
Tax:	
Fee / Fuel:	
Other Chrg: No	

Today Tons:	1,057.20	Loads:
Tons To Date:	15,690.46	42
Today Tonnes	959.08	
Tonnes To Date:	14,234.15	

Carrier : 9070401 EAZY TRUCKING LLC
Vehicle: EAZY1 AS757R
License: AS757R
MaxGVW: 80,000
Received:
Weighmaster: Colleen LeSage

By acceptance of this ticket (with or without signature), driver accepts on behalf of themselves/their employer sole responsibility to ensure that the load received is within the weight limit authorized by law and shall hold harmless against any and all claims with respect to same CURB DELIVERY ONLY. NOT RESPONSIBLE FOR ANY DAMAGE BEYOND CURB.

Cust:

P/D Status: Deliver

Customer Do Not Accept [1] Scale: 1



Plant: 32411

Berlin
368 New Brooklyn Road
Berlin, NJ 08009
856-809-0142

4/3/2017 12:56 In :
Customer: 8638404 THE AMBIENT GROUP LLC
Order : 950949 Camden, NJ. ABC Barrel Project
P.O. :

Tkt. No. 1006028308

Product 114203
Bank Run
S.O. Info: Camden, NJ.
Ship Ref: 327 N. Front St



	Pounds	Kilo
Gross	70,980	32,196
Tare	25,120 *	11,394
Net	45,860	20,802

22.93 Ton 20.80

* Predetermined Tare

	UNIT	TOTALS
Material:		
Freight:		
Tax:		
Fee / Fuel:		
Other Chrg:	No	

Today Tons:	1,080.13	Loads:
Tons To Date:	15,713.39	43
Today Tonnes	979.88	
Tonnes To Date:	14,254.95	

Carrier : 8960583 QW TRUCKING LLC
Vehicle: QW11 AS569P
License:
MaxGVW: 80,000

By acceptance of this ticket (with or without signature), driver accepts on behalf of themselves/their employer sole responsibility to ensure that the load received is within the weight limit authorized by law and shall hold seller harmless against any and all claims with respect to same CURB DELIVERY ONLY .NOT RESPONSIBLE FOR ANY DAMAGE BEYOND CURB.

Received: [Signature]
Weighmaster: Colleen LeSage

Cust: _____

P/D Status: Deliver

Customer Copy

Scale: 1



Plant: 32411

Berlin
368 New Brooklyn Road
Berlin, NJ 08009
856-809-0142

4/3/2017 12:57 In :
Customer: 8638404 THE AMBIENT GROUP LLC
Order : 950949 Camden, NJ. ABC Barrel Project
P.O. :

Tkt. No. 1006028309

Product 114203
Bank Run
S.O. Info: Camden, NJ.
Ship Ref: 327 N. Front St



	Pounds	Kilo
Gross	79,280	35,961
Tare	28,700 *	13,018
Net	50,580	22,943

25.29 Ton 22.94

* Predetermined Tare

	UNIT	TOTALS
Material:		
Freight:		
Tax:		
Fee / Fuel:		
Other Chrg:	No	

Today Tons:	1,105.42	Loads:
Tons To Date:	15,738.68	44
Today Tonnes	1,002.82	
Tonnes To Date:	14,277.89	

By acceptance of this ticket (with or without signature), driver accepts on behalf of themselves/their employer sole responsibility to ensure that the load received is within the weight limit authorized by law and shall hold seller harmless against any and all claims with respect to same CURB DELIVERY ONLY .NOT RESPONSIBLE FOR ANY DAMAGE BEYOND CURB.

Carrier : 8040648 GJ SCOTT LLC
Vehicle: GS15 GS15
License: AS672T
MaxGVW: 80,000

Cust: _____

Received: [Signature]
Weighmaster: Colleen LeSage

P/D Status: Deliver

Customer Copy

Scale: 1



Plant: 32411

Berlin

368 New Brooklyn Road
Berlin, NJ 08009
856-809-0142

4/3/2017 13:03 In :
Customer: 8638404 THE AMBIENT GROUP LLC
Order : 950949 Camden, NJ. ABC Barrel Project
P.O. :

Tkt. No. 1006028310

Product 114203
Bank Run
S.O. Info: Camden, NJ
Ship Ref: 327 N. Front St



	Pounds	Kilo
Gross	78,000	35,380
Tare	27,640 *	12,537
Net	50,360	22,843

25.18 Ton 22.84

* Predetermined Tare

	UNIT	TOTALS
Material:		
Freight:		
Tax:		
Fee / Fuel:		
Other Chrg: No		

Today Tons:	1,130.60	Loads:
Tons To Date:	15,763.86	45
Today Tonnes	1,025.66	
Tonnes To Date:	14,300.73	

Carrier : 9249110 CLM CONTRACTING LLC
Vehicle: CLM6 CLM6
License: AT597T
MaxGVW: 80,000

By acceptance of this ticket (with or without signature), driver accepts on behalf of themselves/their employer sole responsibility to ensure that the load received is within the weight limit authorized by law and shall hold seller harmless against any and all claims with respect to same CURB DELIVERY ONLY. NOT RESPONSIBLE FOR ANY DAMAGE BEYOND CURB.

Received: _____ Cust: _____

Weighmaster: Colleen LeSage

P/D Status: Deliver

Customer Copy

Scale: 1



Plant: 32411

Berlin

368 New Brooklyn Road
Berlin, NJ 08009
856-809-0142

4/3/2017 13:05 In :
Customer: 8638404 THE AMBIENT GROUP LLC
Order : 950949 Camden, NJ. ABC Barrel Project
P.O. :

Tkt. No. 1006028311

Product 114203
Bank Run
S.O. Info: Camden, NJ
Ship Ref: 327 N. Front St



	Pounds	Kilo
Gross	78,060	35,407
Tare	23,520 *	10,668
Net	54,540	24,739

27.27 Ton 24.74

* Predetermined Tare

	UNIT	TOTALS
Material:		
Freight:		
Tax:		
Fee / Fuel:		
Other Chrg: No		

Today Tons:	1,157.87	Loads:
Tons To Date:	15,791.13	46
Today Tonnes	1,050.40	
Tonnes To Date:	14,325.47	

Carrier : 9285292 BLUESTONE CONTRACTING C
Vehicle: SB11 XDUX86
License: XDUX86
MaxGVW: 80,000

By acceptance of this ticket (with or without signature), driver accepts on behalf of themselves/their employer sole responsibility to ensure that the load received is within the weight limit authorized by law and shall hold seller harmless against any and all claims with respect to same CURB DELIVERY ONLY. NOT RESPONSIBLE FOR ANY DAMAGE BEYOND CURB.

Received: _____ Cust: _____

Weighmaster: Colleen LeSage

P/D Status: Deliver

Customer Copy

Scale: 1



Plant: 32411

Berlin

368 New Brooklyn Road
Berlin, NJ 08009
856-809-0142

4/3/2017 13:06 In:
Customer: 8638404 THE AMBIENT GROUP LLC
Order : 950949 Camden, NJ. ABC Barrel Project
P.O. :

Tkt. No. 1006028312

Product 114203
Bank Run
S.O. Info: Camden, NJ.
Ship Ref: 327 N. Front St



	Pounds	Kilo
Gross	78,900	35,788
Tare	27,100 *	12,292
Net	51,800	23,496

25.90 Ton 23.50
* Predetermined Tare

Material:	UNIT	TOTALS
Freight:		
Tax:		
Fee / Fuel:		
Other Chrg: No		

Today Tons:	1,183.77	Loads:
Tons To Date:	15,817.03	47
Today Tonnes	1,073.90	
Tonnes To Date:	14,348.97	

By acceptance of this ticket (with or without signature), driver accepts on behalf of themselves/their employer sole responsibility to ensure that the load received is within the weight limit authorized by law and shall hold seller harmless against any and all claims with respect to same CURB DELIVERY ONLY. NOT RESPONSIBLE FOR ANY DAMAGE BEYOND CURB.

Carrier : 8040648 GJ SCOTT LLC

Vehicle: GS6 GS6

License: AK761C

MaxGVW: 80,000

Received:

Cust: _____

Weighmaster: Colleen LeSage

P/D Status: Deliver

Customer Copy

Scale: 1



Plant: 32411

Berlin

368 New Brooklyn Road
Berlin, NJ 08009
856-809-0142

4/3/2017 13:08 In:
Customer: 8638404 THE AMBIENT GROUP LLC
Order : 950949 Camden, NJ. ABC Barrel Project
P.O. :

Tkt. No. 1006028313

Product 114203
Bank Run
S.O. Info: Camden, NJ.
Ship Ref: 327 N. Front St

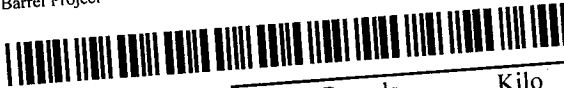

	Pounds	Kilo
Gross	77,240	35,035
Tare	28,040 *	12,719
Net	49,200	22,317

24.60 Ton 22.32
* Predetermined Tare

Material:	UNIT	TOTALS
Freight:		
Tax:		
Fee / Fuel:		
Other Chrg: No		

Today Tons:	1,208.37	Loads:
Tons To Date:	15,841.63	48
Today Tonnes	1,096.21	
Tonnes To Date:	14,371.28	

By acceptance of this ticket (with or without signature), driver accepts on behalf of themselves/their employer sole responsibility to ensure that the load received is within the weight limit authorized by law and shall hold seller harmless against any and all claims with respect to same CURB DELIVERY ONLY. NOT RESPONSIBLE FOR ANY DAMAGE BEYOND CURB.

Carrier : 8960583 QW TRUCKING LLC

Vehicle: QW7 QW7

License: AS914T

MaxGVW: 80,000

Received:

Cust: _____

Weighmaster: Colleen LeSage

P/D Status: Deliver

Customer Copy

Scale: 1



Plant: 32411

Berlin

368 New Brooklyn Road
Berlin, NJ 08009
856-809-0142

4/3/2017 13:09 In :
Customer: 8638404 THE AMBIENT GROUP LLC
Order : 950949 Camden, NJ. ABC Barrel Project
P.O. :

Tkt. No. 1006028314



Product 114203
Bank Run
S.O. Info: Camden, NJ.
Ship Ref: 327 N. Front St

	Pounds	Kilo
Gross	79,240	35,943
Tare	28,780 *	13,054
Net	50,460	22,888

25.23 Ton 22.89

* Predetermined Tare

	UNIT	TOTALS
Material:		
Freight:		
Tax:		
Fee / Fuel:		
Other Chrg: No		

Today Tons:	1,233.60	Loads:
Tons To Date:	15,866.86	49
Today Tonnes	1,119.10	
Tonnes To Date:	14,394.17	

Carrier : 8040648 GJ SCOTT LLC
Vehicle: GS14 GS14
License: As672T
MaxGVW: 80,000

By acceptance of this ticket (with or without signature), driver accepts on behalf of themselves/their employer sole responsibility to ensure that the load received is within the weight limit authorized by law and shall hold seller harmless against any and all claims with respect to same CURB DELIVERY ONLY. NOT RESPONSIBLE FOR ANY DAMAGE BEYOND CURB.

Received: _____
Weighmaster: Colleen LeSage

Cust: _____

P/D Status: Deliver

Customer Copy

Scale: 1



Plant: 32411

Berlin

368 New Brooklyn Road
Berlin, NJ 08009
856-809-0142

4/3/2017 13:11 In :
Customer: 8638404 THE AMBIENT GROUP LLC
Order : 950949 Camden, NJ. ABC Barrel Project
P.O. :

Tkt. No. 1006028315



Product 114203
Bank Run
S.O. Info: Camden, NJ.
Ship Ref: 327 N. Front St

	Pounds	Kilo
Gross	78,220	35,480
Tare	28,160 *	12,773
Net	50,060	22,707

25.03 Ton 22.71

* Predetermined Tare

	UNIT	TOTALS
Material:		
Freight:		
Tax:		
Fee / Fuel:		
Other Chrg: No		

Today Tons:	1,258.63	Loads:
Tons To Date:	15,891.89	50
Today Tonnes	1,141.81	
Tonnes To Date:	14,416.88	

Carrier : 8040648 GJ SCOTT LLC
Vehicle: GS16 GS16
License: AT639K
MaxGVW: 80,000

By acceptance of this ticket (with or without signature), driver accepts on behalf of themselves/their employer sole responsibility to ensure that the load received is within the weight limit authorized by law and shall hold seller harmless against any and all claims with respect to same CURB DELIVERY ONLY. NOT RESPONSIBLE FOR ANY DAMAGE BEYOND CURB.

Received: _____
Weighmaster: Colleen LeSage

Cust: _____

P/D Status: Deliver

Customer Copy

Scale: 1



Plant: 32411

Berlin

368 New Brooklyn Road
Berlin, NJ 08009
856-809-0142

4/3/2017 13:17 In:
Customer: 8638404 THE AMBIENT GROUP LLC
Order : 950949 Camden, NJ. ABC Barrel Project
P.O. :

Tkt. No. 1006028316



Product 114203
Bank Run
S.O. Info: Camden, NJ.
Ship Ref: 327 N. Front St

	Pounds	Kilo
Gross	79,160	35,906
Tare	29,280 *	13,281
Net	49,880	22,625

24.94 Ton 22.63

* Predetermined Tare

	UNIT	TOTALS
Material:		
Freight:		
Tax:		
Fee / Fuel:		
Other Chrg:	No	

Today Tons:	1,283.57	Loads:
Tons To Date:	15,916.83	51
Today Tonnes	1,164.43	
Tonnes To Date:	14,439.51	

Carrier : 8960583 QW TRUCKING LLC

Vehicle: QW19 AS913T

License:

MaxGVW: 80,000

Received:

Weighmaster: Colleen LeSage

P/D Status: Deliver

By acceptance of this ticket (with or without signature), driver accepts on behalf of themselves/their employer sole responsibility to ensure that the load received is within the weight limit authorized by law and shall hold seller harmless against any and all claims with respect to same CURB DELIVERY ONLY. NOT RESPONSIBLE FOR ANY DAMAGE BEYOND CURB.

Cust: _____

Customer Copy

Scale: 1



Plant: 32411

Berlin

368 New Brooklyn Road
Berlin, NJ 08009
856-809-0142

4/3/2017 13:19 In:
Customer: 8638404 THE AMBIENT GROUP LLC
Order : 950949 Camden, NJ. ABC Barrel Project
P.O. :

Tkt. No. 1006028317



Product 114203
Bank Run
S.O. Info: Camden, NJ.
Ship Ref: 327 N. Front St

	Pounds	Kilo
Gross	79,940	36,260
Tare	28,260 *	12,819
Net	51,680	23,442

25.84 Ton 23.44

* Predetermined Tare

	UNIT	TOTALS
Material:		
Freight:		
Tax:		
Fee / Fuel:		
Other Chrg:	No	

Today Tons:	1,309.41	Loads:
Tons To Date:	15,942.67	52
Today Tonnes	1,187.88	
Tonnes To Date:	14,462.95	

Carrier : 8040648 GJ SCOTT LLC

Vehicle: GS17 GS17

License: AT640K

MaxGVW: 80,000

Received:

Weighmaster: Colleen LeSage

P/D Status: Deliver

By acceptance of this ticket (with or without signature), driver accepts on behalf of themselves/their employer sole responsibility to ensure that the load received is within the weight limit authorized by law and shall hold seller harmless against any and all claims with respect to same CURB DELIVERY ONLY. NOT RESPONSIBLE FOR ANY DAMAGE BEYOND CURB.

Cust: _____

Customer Copy

Scale: 1



Plant: 32411

Berlin

368 New Brooklyn Road
Berlin, NJ 08009
856-809-0142

4/3/2017 13:33 In:
Customer: 8638404 THE AMBIENT GROUP LLC
Order: 950949 Camden, NJ. ABC Barrel Project
P.O.:

Tkt. No. 1006028318

Product 114203
Bank Run
S.O. Info: Camden, NJ.
Ship Ref: 327 N. Front St



	Pounds	Kilo
Gross	77,800	35,289
Tare	27,500 *	12,474
Net	50,300	22,816

25.15 Ton 22.82

* Predetermined Tare

	UNIT	TOTALS
Material:		
Freight:		
Tax:		
Fee / Fuel:		
Other Chrg:	No	

Today Tons:	1,334.56	Loads:
Tons To Date:	15,967.82	53
Today Tonnes	1,210.69	
Tonnes To Date:	14,485.76	

Carrier: 8040648 GJ SCOTT LLC
Vehicle: GS9 GS9
License: AK587X
MaxGVW: 80,000
Received: _____
Weighmaster: Colleen LeSage

By acceptance of this ticket (with or without signature), driver accepts on behalf of themselves/their employer sole responsibility to ensure that the load received is within the weight limit authorized by law and shall hold seller harmless against any and all claims with respect to same CURB DELIVERY ONLY. NOT RESPONSIBLE FOR ANY DAMAGE BEYOND CURB.

Cust: _____

P/D Status: Deliver

Customer Copy

Scale: 1



Plant: 32411

368 New Brooklyn Road
Berlin, NJ 08009
856-809-0142

4/3/2017 13:50 In:
Customer: 8638404 THE AMBIENT GROUP LLC
Order: 950949 Camden, NJ. ABC Barrel Project
P.O.:

Tkt. No. 1006028319

Product 114203
Bank Run
S.O. Info: Camden, NJ.
Ship Ref: 327 N. Front St

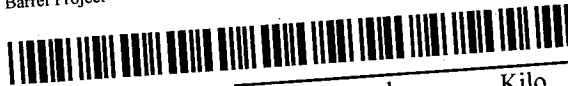

	Pounds	Kilo
Gross	77,620	35,208
Tare	24,760 *	11,231
Net	52,860	23,977

26.43 Ton 23.98

* Predetermined Tare

	UNIT	TOTALS
Material:		
Freight:		
Tax:		
Fee / Fuel:		
Other Chrg:	No	

Today Tons:	1,360.99	Loads:
Tons To Date:	15,994.25	54
Today Tonnes	1,234.67	
Tonnes To Date:	14,509.74	

By acceptance of this ticket (with or without signature), driver accepts on behalf of themselves/their employer sole responsibility to ensure that the load received is within the weight limit authorized by law and shall hold seller harmless against any and all claims with respect to same CURB DELIVERY ONLY. NOT RESPONSIBLE FOR ANY DAMAGE BEYOND CURB.

Cust: _____

Carrier: 9070401 EAZY TRUCKING LLC
Vehicle: EAZY1 AS757R
License: AS757R
MaxGVW: 80,000
Received: _____
Weighmaster: Colleen LeSage

P/D Status: Deliver

Customer Do Not Accept [3]

Scale: 1



Plant: 32411

Berlin

368 New Brooklyn Road
Berlin, NJ 08009
856-809-0142

4/7/2017 07:18 In: 6:29:24
Customer: 8638404 THE AMBIENT GROUP LLC
Order: 950949 Camden, NJ. ABC Barrel Project
P.O.:

Tkt. No. 1006028366

Product 114203
Bank Run
S.O. Info: Camden, NJ.
Ship Ref: 327 N. Front St



	UNIT	TOTALS
Material:		
Freight:		
Tax:		
Fee / Fuel:		
Other Chrg: <u>No</u>		

	Pounds	Kilo
Gross	78,500	35,607
Tare	27,860	12,637
Net	50,640	22,970
	25.32 Ton	22.97

Today Tons:	25.32	Loads:
Tons To Date:	16,019.57	1
Today Tonnes	22.97	
Tonnes To Date:	14,532.71	

Carrier: 9249110 CLM CONTRACTING LLC
Vehicle: CLM6 CLM6
License: AT597T
MaxGVW: 80,000

By acceptance of this ticket (with or without signature), driver accepts on behalf of themselves/their employer sole responsibility to ensure that the load received is within the weight limit authorized by law and shall hold seller harmless against any and all claims with respect to same
CURB DELIVERY ONLY. NOT RESPONSIBLE FOR ANY DAMAGE BEYOND CURB.

Received: [Signature] Weighmaster: Colleen LeSage

Cust: _____

P/D Status: Deliver

Customer Do Not Accept [1] Scale: 1



Plant: 32411

Berlin

368 New Brooklyn Road
Berlin, NJ 08009
856-809-0142

4/7/2017 07:20 In: 6:29:55
Customer: 8638404 THE AMBIENT GROUP LLC
Order: 950949 Camden, NJ. ABC Barrel Project
P.O.:

Tkt. No. 1006028367

Product 114203
Bank Run
S.O. Info: Camden, NJ.
Ship Ref: 327 N. Front St



	UNIT	TOTALS
Material:		
Freight:		
Tax:		
Fee / Fuel:		
Other Chrg: <u>No</u>		

	Pounds	Kilo
Gross	79,320	35,979
Tare	28,400	12,882
Net	50,920	23,097
	25.46 Ton	23.10

Today Tons:	50.78	Loads:
Tons To Date:	16,045.03	2
Today Tonnes	46.07	
Tonnes To Date:	14,555.81	

Carrier: 8040648 GJ SCOTT LLC
Vehicle: GS17 GS17
License: AT640K
MaxGVW: 80,000

By acceptance of this ticket (with or without signature), driver accepts on behalf of themselves/their employer sole responsibility to ensure that the load received is within the weight limit authorized by law and shall hold seller harmless against any and all claims with respect to same
CURB DELIVERY ONLY. NOT RESPONSIBLE FOR ANY DAMAGE BEYOND CURB.

Received: _____ Weighmaster: Colleen LeSage

Cust: _____

P/D Status: Deliver

Customer Copy Scale: 1



Plant: 32411

Berlin

368 New Brooklyn Road
Berlin, NJ 08009
856-809-0142

4/7/2017 07:22 In: 6:30:39
Customer: 8638404 THE AMBIENT GROUP LLC
Order : 950949 Camden, NJ. ABC Barrel Project
P.O. :

Tkt. No. 1006028368



Product 114203
Bank Run
S.O. Info: Camden, NJ.
Ship Ref: 327 N. Front St

	Pounds	Kilo
Gross	76,820	34,845
Tare	27,400	12,428
Net	49,420	22,417

24.71 Ton 22.42

	UNIT	TOTALS
Material:		
Freight:		
Tax:		
Fee / Fuel:		
Other Chrg: No		

Today Tons:	75.49	Loads:
Tons To Date:	16,069.74	3
Today Tonnes	68.48	
Tonnes To Date:	14,578.22	

By acceptance of this ticket (with or without signature), driver accepts on behalf of themselves/their employer sole responsibility to ensure that the load received is within the weight limit authorized by law and shall hold seller harmless against any and all claims with respect to same CURB DELIVERY ONLY. NOT RESPONSIBLE FOR ANY DAMAGE BEYOND CURB.

Carrier : 8040648 GJ SCOTT LLC

Vehicle: GS9 GS9

License: AK587X

MaxGVW: 80,000

Received:

Cust: _____

Weighmaster: Colleen LeSage

P/D Status: Deliver

Customer Copy

Scale: 1



Plant: 32411

Berlin

368 New Brooklyn Road
Berlin, NJ 08009
856-809-0142

4/7/2017 07:23 In: 6:31:01
Customer: 8638404 THE AMBIENT GROUP LLC
Order : 950949 Camden, NJ. ABC Barrel Project
P.O. :

Tkt. No. 1006028369



Product 114203
Bank Run
S.O. Info: Camden, NJ.
Ship Ref: 327 N. Front St

	Pounds	Kilo
Gross	78,340	35,534
Tare	28,060	12,728
Net	50,280	22,807

25.14 Ton 22.81

	UNIT	TOTALS
Material:		
Freight:		
Tax:		
Fee / Fuel:		
Other Chrg: No		

Today Tons:	100.63	Loads:
Tons To Date:	16,094.88	4
Today Tonnes	91.29	
Tonnes To Date:	14,601.03	

By acceptance of this ticket (with or without signature), driver accepts on behalf of themselves/their employer sole responsibility to ensure that the load received is within the weight limit authorized by law and shall hold seller harmless against any and all claims with respect to same CURB DELIVERY ONLY. NOT RESPONSIBLE FOR ANY DAMAGE BEYOND CURB.

Carrier : 8040648 GJ SCOTT LLC

Vehicle: GS4 GS4

License: AJ118L

MaxGVW: 80,000

Received:

Cust: _____

Weighmaster: Colleen LeSage

P/D Status: Deliver

Customer Do Not Accept [1]

Scale: 1



Plant: 32411

Berlin

368 New Brooklyn Road
Berlin, NJ 08009
856-809-0142

4/7/2017 08:48 In :
Customer: 8638404 THE AMBIENT GROUP LLC
Order : 950949 Camden, NJ. ABC Barrel Project
P.O. :

Tkt. No. 1006028379

Product 114203
Bank Run
S.O. Info: Camden, NJ.
Ship Ref: 327 N. Front St



	Pounds	Kilo
Gross	78,760	35,725
Tare	28,400 *	12,882
Net	50,360	22,843

25.18 Ton 22.84

* Predetermined Tare

	UNIT	TOTALS
Material:		
Freight:		
Tax:		
Fee / Fuel:		
Other Chrg: No		

Today Tons:	125.81	Loads:
Tons To Date:	16,120.06	5
Today Tonnes	114.13	
Tonnes To Date:	14,623.87	

Carrier : 8040648 GJ SCOTT LLC
Vehicle: GS17 GS17
License: AT640K
MaxGVW: 80,000

By acceptance of this ticket (with or without signature), driver accepts on behalf of themselves/their employer sole responsibility to ensure that the load received is within the weight limit authorized by law and shall holdseller harmless against any and all claims with respect to same CURB DELIVERY ONLY. NOT RESPONSIBLE FOR ANY DAMAGE BEYOND CURB.

Received: _____

Cust: _____

Weighmaster: Colleen LeSage

P/D Status: Deliver

Customer Copy

Scale: 1



Plant: 32411

Berlin

368 New Brooklyn Road
Berlin, NJ 08009
856-809-0142

4/7/2017 08:50 In :
Customer: 8638404 THE AMBIENT GROUP LLC
Order : 950949 Camden, NJ. ABC Barrel Project
P.O. :

Tkt. No. 1006028380

Product 114203
Bank Run
S.O. Info: Camden, NJ.
Ship Ref: 327 N. Front St



	Pounds	Kilo
Gross	78,200	35,471
Tare	27,860 *	12,637
Net	50,340	22,834

25.17 Ton 22.83

* Predetermined Tare

	UNIT	TOTALS
Material:		
Freight:		
Tax:		
Fee / Fuel:		
Other Chrg: No		

Today Tons:	150.98	Loads:
Tons To Date:	16,145.23	6
Today Tonnes	136.97	
Tonnes To Date:	14,646.71	

Carrier : 9249110 CLM CONTRACTING LLC
Vehicle: CLM6 CLM6
License: AT597T
MaxGVW: 80,000

By acceptance of this ticket (with or without signature), driver accepts on behalf of themselves/their employer sole responsibility to ensure that the load received is within the weight limit authorized by law and shall holdseller harmless against any and all claims with respect to same CURB DELIVERY ONLY. NOT RESPONSIBLE FOR ANY DAMAGE BEYOND CURB.

Received: _____

Cust: _____

Weighmaster: Colleen LeSage

P/D Status: Deliver

Customer Copy

Scale: 1



Plant: 32411

Berlin

368 New Brooklyn Road
Berlin, NJ 08009
856-809-0142

4/7/2017 08:54 In :
Customer: 8638404 THE AMBIENT GROUP LLC
Order : 950949 Camden, NJ. ABC Barrel Project
P.O. :

Tkt. No. 1006028381

Product 114203
Bank Run
S.O. Info: Camden, NJ.
Ship Ref: 327 N. Front St



	Pounds	Kilo
Gross	78,220	35,480
Tare	27,400 *	12,428
Net	50,820	23,052

25.41 Ton 23.05

* Predetermined Tare

	UNIT	TOTALS
Material:		
Freight:		
Tax:		
Fee / Fuel:		
Other Chrg: No		

Today Tons:	176.39	Loads:
Tons To Date:	16,170.64	7
Today Tonnes	160.02	
Tonnes To Date:	14,669.76	

Carrier : 8040648 GJ SCOTT LLC
Vehicle: GS9 GS9
License: AK587X
MaxGVW: 80,000

By acceptance of this ticket (with or without signature), driver accepts on behalf of themselves/their employer sole responsibility to ensure that the load received is within the weight limit authorized by law and shall hold seller harmless against any and all claims with respect to same CURB DELIVERY ONLY. NOT RESPONSIBLE FOR ANY DAMAGE BEYOND CURB.

Received: 
Weighmaster: Colleen LeSage

Cust: _____

P/D Status: Deliver

Customer Copy

Scale: 1



Plant: 32411

Berlin

368 New Brooklyn Road
Berlin, NJ 08009
856-809-0142

4/7/2017 08:55 In :
Customer: 8638404 THE AMBIENT GROUP LLC
Order : 950949 Camden, NJ. ABC Barrel Project
P.O. :

Tkt. No. 1006028382

Product 114203
Bank Run
S.O. Info: Camden, NJ.
Ship Ref: 327 N. Front St



	Pounds	Kilo
Gross	78,480	35,598
Tare	27,100 *	12,292
Net	51,380	23,306

25.69 Ton 23.31

* Predetermined Tare

	UNIT	TOTALS
Material:		
Freight:		
Tax:		
Fee / Fuel:		
Other Chrg: No		

Today Tons:	202.08	Loads:
Tons To Date:	16,196.33	8
Today Tonnes	183.32	
Tonnes To Date:	14,693.06	

Carrier : 8040648 GJ SCOTT LLC
Vehicle: GS6 GS6
License: AK761C
MaxGVW: 80,000

By acceptance of this ticket (with or without signature), driver accepts on behalf of themselves/their employer sole responsibility to ensure that the load received is within the weight limit authorized by law and shall hold seller harmless against any and all claims with respect to same CURB DELIVERY ONLY. NOT RESPONSIBLE FOR ANY DAMAGE BEYOND CURB.

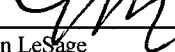
Received: 
Weighmaster: Colleen LeSage

Cust: _____

P/D Status: Deliver

Customer Copy

Scale: 1



Plant: 32411

Berlin

368 New Brooklyn Road
Berlin, NJ 08009
856-809-0142

4/7/2017 10:18

In :

Customer: 8638404 THE AMBIENT GROUP LLC

Order : 950949 Camden, NJ. ABC Barrel Project

P.O. :

Tkt. No. 1006028387

Product 114203

Bank Run

S.O. Info: Camden, NJ.

Ship Ref: 327 N. Front St



	Pounds	Kilo
Gross	79,240	35,943
Tare	28,400 *	12,882
Net	50,840	23,061

25.42 Ton 23.06

* Predetermined Tare

	UNIT	TOTALS
Material:		
Freight:		
Tax:		
Fee / Fuel:		
Other Chrg: No		

Today Tons:	227.50	Loads:
Tons To Date:	16,221.75	9
Today Tonnes	206.38	
Tonnes To Date:	14,716.12	

By acceptance of this ticket (with or without signature), driver accepts on behalf of themselves/their employer sole responsibility to ensure that the load received is within the weight limit authorized by law and shall hold seller harmless against any and all claims with respect to same CURB DELIVERY ONLY. NOT RESPONSIBLE FOR ANY DAMAGE BEYOND CURB.

Carrier : 8040648 GJ SCOTT LLC

Vehicle: GS17 GS17

License: AT640K

MaxGVW: 80,000

Received: _____

Cust: _____

Weighmaster: Colleen LeSage

P/D Status: Deliver

Customer Copy

Scale: 1



Plant: 32411

Berlin

368 New Brooklyn Road
Berlin, NJ 08009
856-809-0142

4/7/2017 10:20

In :

Customer: 8638404 THE AMBIENT GROUP LLC

Order : 950949 Camden, NJ. ABC Barrel Project

P.O. :

Tkt. No. 1006028388

Product 114203

Bank Run

S.O. Info: Camden, NJ.

Ship Ref: 327 N. Front St



	Pounds	Kilo
Gross	77,620	35,208
Tare	27,400 *	12,428
Net	50,220	22,779

25.11 Ton 22.78

* Predetermined Tare

	UNIT	TOTALS
Material:		
Freight:		
Tax:		
Fee / Fuel:		
Other Chrg: No		

Today Tons:	252.61	Loads:
Tons To Date:	16,246.86	10
Today Tonnes	229.16	
Tonnes To Date:	14,738.90	

By acceptance of this ticket (with or without signature), driver accepts on behalf of themselves/their employer sole responsibility to ensure that the load received is within the weight limit authorized by law and shall hold seller harmless against any and all claims with respect to same CURB DELIVERY ONLY. NOT RESPONSIBLE FOR ANY DAMAGE BEYOND CURB.

Carrier : 8040648 GJ SCOTT LLC

Vehicle: GS9 GS9

License: AK587X

MaxGVW: 80,000

Received: _____

Cust: _____

Weighmaster: Colleen LeSage

P/D Status: Deliver

Customer Do Not Accept [1]

Scale: 1



Plant: 32411

Berlin

368 New Brooklyn Road
Berlin, NJ 08009
856-809-0142

4/7/2017 10:23 In :
Customer: 8638404 THE AMBIENT GROUP LLC
Order : 950949 Camden, NJ. ABC Barrel Project
P.O. :

Tkt. No. 1006028389

Product 114203
Bank Run
S.O. Info: Camden, NJ.
Ship Ref: 327 N. Front St



	Pounds	Kilo
Gross	78,660	35,680
Tare	28,060 *	12,728
Net	50,600	22,952

25.30 Ton 22.95
* Predetermined Tare

	UNIT	TOTALS
Material:		
Freight:		
Tax:		
Fee / Fuel:		
Other Chrg: No		

Today Tons:	277.91	Loads:
Tons To Date:	16,272.16	11
Today Tonnes	252.12	
Tonnes To Date:	14,761.86	

Carrier : 8040648 GJ SCOTT LLC
Vehicle: GS4 GS4
License: AJ118L
MaxGVW: 80,000
Received: _____
Weighmaster: Colleen LeSage

By acceptance of this ticket (with or without signature), driver accepts on behalf of themselves/their employer sole responsibility to ensure that the load received is within the weight limit authorized by law and shall hold seller harmless against any and all claims with respect to same
CURB DELIVERY ONLY. NOT RESPONSIBLE FOR ANY DAMAGE BEYOND CURB.

Cust: _____

P/D Status: Deliver

Customer Do Not Accept [1] Scale: 1



Plant: 32411

Berlin

368 New Brooklyn Road
Berlin, NJ 08009
856-809-0142

4/7/2017 10:27 In :
Customer: 8638404 THE AMBIENT GROUP LLC
Order : 950949 Camden, NJ. ABC Barrel Project
P.O. :

Tkt. No. 1006028390

Product 114203
Bank Run
S.O. Info: Camden, NJ.
Ship Ref: 327 N. Front St



	Pounds	Kilo
Gross	77,720	35,253
Tare	27,860 *	12,637
Net	49,860	22,616

24.93 Ton 22.62
* Predetermined Tare

	UNIT	TOTALS
Material:		
Freight:		
Tax:		
Fee / Fuel:		
Other Chrg: No		

Today Tons:	302.84	Loads:
Tons To Date:	16,297.09	12
Today Tonnes	274.73	
Tonnes To Date:	14,784.47	

Carrier : 9249110 CLM CONTRACTING LLC
Vehicle: CLM6 CLM6
License: AT597T
MaxGVW: 80,000
Received: _____
Weighmaster: Colleen LeSage

By acceptance of this ticket (with or without signature), driver accepts on behalf of themselves/their employer sole responsibility to ensure that the load received is within the weight limit authorized by law and shall hold seller harmless against any and all claims with respect to same
CURB DELIVERY ONLY. NOT RESPONSIBLE FOR ANY DAMAGE BEYOND CURB.

Cust: _____

P/D Status: Deliver

Customer Copy Scale: 1



Plant: 32411

Berlin

368 New Brooklyn Road
Berlin, NJ 08009
856-809-0142

4/7/2017 11:50 In :
Customer: 8638404 THE AMBIENT GROUP LLC
Order : 950949 Camden, NJ. ABC Barrel Project
P.O. :

Tkt. No. 1006028399



Product 114203
Bank Run
S.O. Info: Camden, NJ.
Ship Ref: 327 N. Front St

	Pounds	Kilo
Gross	78,320	35,525
Tare	28,400 *	12,882
Net	49,920	22,643

24.96 Ton 22.64

* Predetermined Tare

	UNIT	TOTALS
Material:		
Freight:		
Tax:		
Fee / Fuel:		
Other Chrg: No		

Today Tons:	327.80	Loads:
Tons To Date:	16,322.05	13
Today Tonnes	297.38	
Tonnes To Date:	14,807.11	

By acceptance of this ticket (with or without signature), driver accepts on behalf of themselves/their employer sole responsibility to ensure that the load received is within the weight limit authorized by law and shall hold seller harmless against any and all claims with respect to same CURB DELIVERY ONLY. NOT RESPONSIBLE FOR ANY DAMAGE BEYOND CURB.

Carrier : 8040648 GJ SCOTT LLC

Vehicle: GS17 GS17

License: AT640K

MaxGVW: 80,000

Received: _____

Cust: _____

Weighmaster: Colleen LeSage

P/D Status: Deliver

Customer Copy

Scale: 1



Plant: 32411

Berlin

368 New Brooklyn Road
Berlin, NJ 08009
856-809-0142

4/7/2017 11:52 In :
Customer: 8638404 THE AMBIENT GROUP LLC
Order : 950949 Camden, NJ. ABC Barrel Project
P.O. :

Tkt. No. 1006028400



Product 114203
Bank Run
S.O. Info: Camden, NJ.
Ship Ref: 327 N. Front St

	Pounds	Kilo
Gross	77,380	35,099
Tare	27,400 *	12,428
Net	49,980	22,671

24.99 Ton 22.67

* Predetermined Tare

	UNIT	TOTALS
Material:		
Freight:		
Tax:		
Fee / Fuel:		
Other Chrg: No		

Today Tons:	352.79	Loads:
Tons To Date:	16,347.04	14
Today Tonnes	320.05	
Tonnes To Date:	14,829.79	

By acceptance of this ticket (with or without signature), driver accepts on behalf of themselves/their employer sole responsibility to ensure that the load received is within the weight limit authorized by law and shall hold seller harmless against any and all claims with respect to same CURB DELIVERY ONLY. NOT RESPONSIBLE FOR ANY DAMAGE BEYOND CURB.

Carrier : 8040648 GJ SCOTT LLC

Vehicle: GS9 GS9

License: AK587X

MaxGVW: 80,000

Received: _____

Cust: _____

Weighmaster: Colleen LeSage

P/D Status: Deliver

Customer Copy

Scale: 1



Plant: 32411

Berlin

368 New Brooklyn Road
Berlin, NJ 08009
856-809-0142

4/7/2017 11:54 In :
Customer: 8638404 THE AMBIENT GROUP LLC
Order : 950949 Camden, NJ. ABC Barrel Project
P.O. :

Tkt. No. 1006028401

Product 114203
Bank Run
S.O. Info: Camden, NJ.
Ship Ref: 327 N. Front St



	Pounds	Kilo
Gross	78,560	35,634
Tare	28,060 *	12,728
Net	50,500	22,906

25.25 Ton 22.91

* Predetermined Tare

Today Tons:	378.04	Loads:
Tons To Date:	16,372.29	15
Today Tonnes	342.95	
Tonnes To Date:	14,852.69	

	UNIT	TOTALS
Material:		
Freight:		
Tax:		
Fee / Fuel:		
Other Chrg: No		

Carrier : 8040648 GJ SCOTT LLC

Vehicle: GS4 GS4

License: AJ118L

MaxGVW: 80,000

Received:

Weighmaster: Colleen LeSage

P/D Status: Deliver

Cust: _____

By acceptance of this ticket (with or without signature), driver accepts on behalf of themselves/their employer sole responsibility to ensure that the load received is within the weight limit authorized by law and shall hold seller harmless against any and all claims with respect to same CURB DELIVERY ONLY. NOT RESPONSIBLE FOR ANY DAMAGE BEYOND CURB.

Customer Do Not Accept [1] Scale: 1



Plant: 32411

Berlin

368 New Brooklyn Road
Berlin, NJ 08009
856-809-0142

4/7/2017 11:58 In :
Customer: 8638404 THE AMBIENT GROUP LLC
Order : 950949 Camden, NJ. ABC Barrel Project
P.O. :

Tkt. No. 1006028402

Product 114203
Bank Run
S.O. Info: Camden, NJ.
Ship Ref: 327 N. Front St



	Pounds	Kilo
Gross	78,080	35,416
Tare	27,860 *	12,637
Net	50,220	22,779

25.11 Ton 22.78

* Predetermined Tare

Today Tons:	403.15	Loads:
Tons To Date:	16,397.40	16
Today Tonnes	365.73	
Tonnes To Date:	14,875.47	

	UNIT	TOTALS
Material:		
Freight:		
Tax:		
Fee / Fuel:		
Other Chrg: No		

Carrier : 9249110 CLM CONTRACTING LLC

Vehicle: CLM6 CLM6

License: AT597T

MaxGVW: 80,000

Received:

Weighmaster: Colleen LeSage

P/D Status: Deliver

Cust: _____

By acceptance of this ticket (with or without signature), driver accepts on behalf of themselves/their employer sole responsibility to ensure that the load received is within the weight limit authorized by law and shall hold seller harmless against any and all claims with respect to same CURB DELIVERY ONLY. NOT RESPONSIBLE FOR ANY DAMAGE BEYOND CURB.

Customer Do Not Accept [1] Scale: 1



Plant: 32411

Berlin

368 New Brooklyn Road
Berlin, NJ 08009
856-809-0142

4/7/2017 13:11 In :
Customer: 8638404 THE AMBIENT GROUP LLC
Order : 950949 Camden, NJ. ABC Barrel Project
P.O. :

Tkt. No. 1006028407

Product 114203
Bank Run
S.O. Info: Camden, NJ.
Ship Ref: 327 N. Front St



	Pounds	Kilo
Gross	78,640	35,670
Tare	28,400 *	12,882
Net	50,240	22,788

25.12 Ton 22.79

* Predetermined Tare

	UNIT	TOTALS
Material:		
Freight:		
Tax:		
Fee / Fuel:		
Other Chrg: No		

Today Tons:	428.27	Loads:
Tons To Date:	16,422.52	17
Today Tonnes	388.52	
Tonnes To Date:	14,898.26	

By acceptance of this ticket (with or without signature), driver accepts on behalf of themselves/their employer sole responsibility to ensure that the load received is within the weight limit authorized by law and shall hold seller harmless against any and all claims with respect to same CURB DELIVERY ONLY. NOT RESPONSIBLE FOR ANY DAMAGE BEYOND CURB.

Carrier : 8040648 GJ SCOTT LLC
Vehicle: GS17 GS17
License: AT640K
MaxGVW: 80,000

Received: _____
Weighmaster: Colleen LeSage

Cust: _____

P/D Status: Deliver

Customer Copy

Scale: 1



Plant: 32411

Berlin

368 New Brooklyn Road
Berlin, NJ 08009
856-809-0142

4/7/2017 13:14 In :
Customer: 8638404 THE AMBIENT GROUP LLC
Order : 950949 Camden, NJ. ABC Barrel Project
P.O. :

Tkt. No. 1006028408

Product 114203
Bank Run
S.O. Info: Camden, NJ.
Ship Ref: 327 N. Front St



	Pounds	Kilo
Gross	77,560	35,181
Tare	27,400 *	12,428
Net	50,160	22,752

25.08 Ton 22.75

* Predetermined Tare

	UNIT	TOTALS
Material:		
Freight:		
Tax:		
Fee / Fuel:		
Other Chrg: No		

Today Tons:	453.35	Loads:
Tons To Date:	16,447.60	18
Today Tonnes	411.27	
Tonnes To Date:	14,921.01	

By acceptance of this ticket (with or without signature), driver accepts on behalf of themselves/their employer sole responsibility to ensure that the load received is within the weight limit authorized by law and shall hold seller harmless against any and all claims with respect to same CURB DELIVERY ONLY. NOT RESPONSIBLE FOR ANY DAMAGE BEYOND CURB.

Carrier : 8040648 GJ SCOTT LLC
Vehicle: GS9 GS9
License: AK587X
MaxGVW: 80,000

Received: _____
Weighmaster: Colleen LeSage

Cust: _____

P/D Status: Deliver

Customer Do Not Accept [1]

Scale: 1



Plant: 32411

Berlin

368 New Brooklyn Road
Berlin, NJ 08009
856-809-0142

4/7/2017 13:17

In :

Customer: 8638404 THE AMBIENT GROUP LLC

Order : 950949 Camden, NJ. ABC Barrel Project

Tkt. No. 1006028409

P.O. :

Product 114203



Bank Run

S.O. Info: Camden, NJ.

Ship Ref: 327 N. Front St

	Pounds	Kilo
Gross	78,960	35,816
Tare	28,060 *	12,728
Net	50,900	23,088

25.45 Ton 23.09

* Predetermined Tare

	UNIT	TOTALS
Material:		
Freight:		
Tax:		
Fee / Fuel:		
Other Chrg: No		

Today Tons:	478.80	Loads:
Tons To Date:	16,473.05	19
Today Tonnes	434.36	
Tonnes To Date:	14,944.10	

Carrier : 8040648 GJ SCOTT LLC

Vehicle: GS4 GS4

License: AJ118L

MaxGVW: 80,000

Received: 

Cust: _____

Weighmaster: Colleen LeSage

P/D Status: Deliver

By acceptance of this ticket (with or without signature), driver accepts on behalf of themselves/their employer sole responsibility to ensure that the load received is within the weight limit authorized by law and shall hold seller harmless against any and all claims with respect to same
CURB DELIVERY ONLY. NOT RESPONSIBLE FOR ANY DAMAGE BEYOND CURB.

Customer Do Not Accept [1] Scale: 1



Plant: 32411

Berlin

368 New Brooklyn Road
Berlin, NJ 08009
856-809-0142

4/10/2017 07:01

In: 6:39:56

Customer: 8638404 THE AMBIENT GROUP LLC

Order : 950949 Camden, NJ. ABC Barrel Project

P.O. :

Tkt. No. 1006028417

Product 114203

Bank Run

S.O. Info: Camden, NJ.

Ship Ref: 327 N. Front St



	Pounds	Kilo
Gross	78,260	35,498
Tare	27,300	12,383
Net	50,960	23,115
	25.48 Ton	23.12

	UNIT	TOTALS
Material:		
Freight:		
Tax:		
Fee / Fuel:		
Other Chrg: No		

Today Tons:	25.48	Loads:	1
Tons To Date:	16,498.53		
Today Tonnes	23.12		
Tonnes To Date:	14,967.21		

Carrier : 8040648 GJ SCOTT LLC

Vehicle: GS9 GS9

License: AK587X

MaxGVW: 80,000

Received: _____

Weighmaster: Colleen LeSage

Cust: _____

P/D Status: Deliver

By acceptance of this ticket (with or without signature), driver accepts on behalf of themselves/their employer sole responsibility to ensure that the load received is within the weight limit authorized by law and shall hold seller harmless against any and all claims with respect to same
CURB DELIVERY ONLY. NOT RESPONSIBLE FOR ANY DAMAGE BEYOND CURB.

Customer Do Not Accept [1] Scale: 1



Plant: 32411

Berlin

368 New Brooklyn Road
Berlin, NJ 08009
856-809-0142

4/10/2017 07:05

In: 6:40:20

Customer: 8638404 THE AMBIENT GROUP LLC

Order : 950949 Camden, NJ. ABC Barrel Project

P.O. :

Tkt. No. 1006028418

Product 114203

Bank Run

S.O. Info: Camden, NJ.

Ship Ref: 327 N. Front St



	Pounds	Kilo
Gross	78,020	35,389
Tare	28,280	12,828
Net	49,740	22,562
	24.87 Ton	22.56

	UNIT	TOTALS
Material:		
Freight:		
Tax:		
Fee / Fuel:		
Other Chrg: No		

Today Tons:	50.35	Loads:	2
Tons To Date:	16,523.40		
Today Tonnes	45.68		
Tonnes To Date:	14,989.78		

Carrier : 8040648 GJ SCOTT LLC

Vehicle: GS17 GS17

License: AT640K

MaxGVW: 80,000

Received: _____

Weighmaster: Colleen LeSage

Cust: _____

P/D Status: Deliver

By acceptance of this ticket (with or without signature), driver accepts on behalf of themselves/their employer sole responsibility to ensure that the load received is within the weight limit authorized by law and shall hold seller harmless against any and all claims with respect to same
CURB DELIVERY ONLY. NOT RESPONSIBLE FOR ANY DAMAGE BEYOND CURB.

Customer Copy Scale: 1



Plant: 32411

Berlin

368 New Brooklyn Road
Berlin, NJ 08009
856-809-0142

4/10/2017 07:08

In: 6:40:54

Customer: 8638404 THE AMBIENT GROUP LLC

Order: 950949 Camden, NJ. ABC Barrel Project

P.O.:

Tkt. No. 1006028419



Product 114203

Bank Run

S.O. Info: Camden, NJ.

Ship Ref: 327 N. Front St

	Pounds	Kilo
Gross	78,540	35,625
Tare	27,040	12,265
Net	51,500	23,360

25.75 Ton 23.36

Today Tons:	76.10	Loads:
Tons To Date:	16,549.15	3
Today Tonnes	69.04	
Tonnes To Date:	15,013.14	

By acceptance of this ticket (with or without signature), driver accepts on behalf of themselves/their employer sole responsibility to ensure that the load received is within the weight limit authorized by law and shall hold seller harmless against any and all claims with respect to same CURB DELIVERY ONLY. NOT RESPONSIBLE FOR ANY DAMAGE BEYOND CURB.

	UNIT	TOTALS
Material:		
Freight:		
Tax:		
Fee / Fuel:		
Other Chrg: No		

Carrier: 8040648 GJ SCOTT LLC

Vehicle: GS6 GS6

License: AK761C

MaxGVW: 80,000

Received:  Cust: _____

Weighmaster: Colleen LeSage

P/D Status: Deliver

Customer Do Not Accept [1] Scale: 1



Plant: 32411

Berlin

368 New Brooklyn Road
Berlin, NJ 08009
856-809-0142

4/10/2017 07:40

In: 7:32:54

Customer: 8638404 THE AMBIENT GROUP LLC

Order: 950949 Camden, NJ. ABC Barrel Project

P.O.:

Tkt. No. 1006028420



Product 114203

Bank Run

S.O. Info: Camden, NJ.

Ship Ref: 327 N. Front St

	Pounds	Kilo
Gross	75,060	34,047
Tare	25,360	11,503
Net	49,700	22,544

24.85 Ton 22.54

Today Tons:	100.95	Loads:
Tons To Date:	16,574.00	4
Today Tonnes	91.58	
Tonnes To Date:	15,035.68	

By acceptance of this ticket (with or without signature), driver accepts on behalf of themselves/their employer sole responsibility to ensure that the load received is within the weight limit authorized by law and shall hold seller harmless against any and all claims with respect to same CURB DELIVERY ONLY. NOT RESPONSIBLE FOR ANY DAMAGE BEYOND CURB.

	UNIT	TOTALS
Material:		
Freight:		
Tax:		
Fee / Fuel:		
Other Chrg: No		

Carrier: 2347198 RAJO CONTRACTING & MATE

Vehicle: RO230 RAJO John

License: ~~ALS813U~~

MaxGVW: 80,000

Received:  Cust: _____

Weighmaster: Colleen LeSage

P/D Status: Deliver

Customer Copy Scale: 1



Plant: 32411

Berlin

368 New Brooklyn Road
Berlin, NJ 08009
856-809-0142

4/10/2017 07:49 In: 7:32:34
Customer: 8638404 THE AMBIENT GROUP LLC
Order: 950949 Camden, NJ. ABC Barrel Project
P.O.:

Tkt. No. 1006028421

Product 114203
Bank Run
S.O. Info: Camden, NJ.
Ship Ref: 327 N. Front St



	Pounds	Kilo
Gross	79,420	36,024
Tare	25,600	11,612
Net	53,820	24,412
	26.91 Ton	24.41

	UNIT	TOTALS
Material:		
Freight:		
Tax:		
Fee / Fuel:		
Other Chrg: No		

Today Tons:	127.86	Loads:
Tons To Date:	16,600.91	5
Today Tonnes	115.99	
Tonnes To Date:	15,060.09	

Carrier: 2347198 RAIO CONTRACTING & MATE
Vehicle: RO229 RAIO Tommy
License: AS812U
MaxGVW: 80,000

By acceptance of this ticket (with or without signature), driver accepts on behalf of themselves/their employer sole responsibility to ensure that the load received is within the weight limit authorized by law and shall hold seller harmless against any and all claims with respect to same CURB DELIVERY ONLY. NOT RESPONSIBLE FOR ANY DAMAGE BEYOND CURB.

Received: _____
Weighmaster: Colleen LeSage

Cust: _____

P/D Status: Deliver

Customer Copy

Scale: 1



Plant: 32411

Berlin

368 New Brooklyn Road
Berlin, NJ 08009
856-809-0142

4/10/2017 08:37 In:
Customer: 8638404 THE AMBIENT GROUP LLC
Order: 950949 Camden, NJ. ABC Barrel Project
P.O.:

Tkt. No. 1006028425

Product 114203
Bank Run
S.O. Info: Camden, NJ.
Ship Ref: 327 N. Front St



	Pounds	Kilo
Gross	77,520	35,162
Tare	27,300 *	12,383
Net	50,220	22,779
	25.11 Ton	22.78

* Predetermined Tare

	UNIT	TOTALS
Material:		
Freight:		
Tax:		
Fee / Fuel:		
Other Chrg: No		

Today Tons:	152.97	Loads:
Tons To Date:	16,626.02	6
Today Tonnes	138.77	
Tonnes To Date:	15,082.87	

Carrier: 8040648 GJ SCOTT LLC
Vehicle: GS9 GS9
License: AK587X
MaxGVW: 80,000

By acceptance of this ticket (with or without signature), driver accepts on behalf of themselves/their employer sole responsibility to ensure that the load received is within the weight limit authorized by law and shall hold seller harmless against any and all claims with respect to same CURB DELIVERY ONLY. NOT RESPONSIBLE FOR ANY DAMAGE BEYOND CURB.

Received: _____
Weighmaster: Colleen LeSage

Cust: _____

P/D Status: Deliver

Customer Do Not Accept [1]

Scale: 1



Plant: 32411

Berlin

368 New Brooklyn Road
Berlin, NJ 08009
856-809-0142,

4/10/2017 08:40

In :

Customer: 8638404 THE AMBIENT GROUP LLC

Order : 950949 Camden, NJ. ABC Barrel Project

P.O. :

Tkt. No. 1006028426

Product 114203

Bank Run

S.O. Info: Camden, NJ.

Ship Ref: 327 N. Front St



	Pounds	Kilo
Gross	78,420	35,571
Tare	28,280 *	12,828
Net	50,140	22,743

25.07 Ton 22.74

* Predetermined Tare

Today Tons:	178.04	Loads:
Tons To Date:	16,651.09	7
Today Tonnes	161.52	
Tonnes To Date:	15,105.61	

	UNIT	TOTALS
Material:		
Freight:		
Tax:		
Fee / Fuel:		
Other Chrg: No		

Carrier : 8040648 GJ SCOTT LLC

Vehicle: GS17 GS17

License: AT640K

MaxGVW: 80,000

Received: _____

Cust: _____

Weighmaster: Colleen LeSage

P/D Status: Deliver

Customer Copy

Scale: 1

By acceptance of this ticket (with or without signature), driver accepts on behalf of themselves/their employer sole responsibility to ensure that the load received is within the weight limit authorized by law and shall hold seller harmless against any and all claims with respect to same CURB DELIVERY ONLY. NOT RESPONSIBLE FOR ANY DAMAGE BEYOND CURB.



Plant: 32411

Berlin

368 New Brooklyn Road
Berlin, NJ 08009
856-809-0142,

4/10/2017 08:42

In :

Customer: 8638404 THE AMBIENT GROUP LLC

Order : 950949 Camden, NJ. ABC Barrel Project

P.O. :

Tkt. No. 1006028427

Product 114203

Bank Run

S.O. Info: Camden, NJ.

Ship Ref: 327 N. Front St



	Pounds	Kilo
Gross	75,960	34,455
Tare	27,040 *	12,265
Net	48,920	22,190

24.46 Ton 22.19

* Predetermined Tare

Today Tons:	202.50	Loads:
Tons To Date:	16,675.55	8
Today Tonnes	183.70	
Tonnes To Date:	15,127.80	

	UNIT	TOTALS
Material:		
Freight:		
Tax:		
Fee / Fuel:		
Other Chrg: No		

Carrier : 8040648 GJ SCOTT LLC

Vehicle: GS6 GS6

License: AK761C

MaxGVW: 80,000

Received: _____

Cust: _____

Weighmaster: Colleen LeSage

P/D Status: Deliver

Customer Copy

Scale: 1

By acceptance of this ticket (with or without signature), driver accepts on behalf of themselves/their employer sole responsibility to ensure that the load received is within the weight limit authorized by law and shall hold seller harmless against any and all claims with respect to same CURB DELIVERY ONLY. NOT RESPONSIBLE FOR ANY DAMAGE BEYOND CURB.



Plant: 32411

Berlin
368 New Brooklyn Road
Berlin, NJ 08009
856-809-0142

4/10/2017 09:22 In: 8:46:32
Customer: 8638404 THE AMBIENT GROUP LLC
Order: 950949 Camden, NJ. ABC Barrel Project
P.O.:

Tkt. No. 1006028430



Product 114203
Bank Run
S.O. Info: Camden, NJ.
Ship Ref: 327 N. Front St

	Pounds	Kilo
Gross	74,240	33,675
Tare	24,760	11,231
Net	49,480	22,444
	24.74 Ton	22.44

	UNIT	TOTALS
Material:		
Freight:		
Tax:		
Fee / Fuel:		
Other Chrg: No		

Today Tons:	227.24	Loads:
Tons To Date:	16,700.29	9
Today Tonnes	206.15	
Tonnes To Date:	15,150.25	

Carrier: 2347198 RAIO CONTRACTING & MATE
Vehicle: RO213 Raio
License: AH445F
MaxGVW: 80,000
Received: 
Weighmaster: Colleen LeSage

By acceptance of this ticket (with or without signature), driver accepts on behalf of themselves/their employer sole responsibility to ensure that the load received is within the weight limit authorized by law and shall hold seller harmless against any and all claims with respect to same CURB DELIVERY ONLY. NOT RESPONSIBLE FOR ANY DAMAGE BEYOND CURB.

Cust: _____

P/D Status: Deliver

Customer Copy

Scale: 1



Plant: 32411

Berlin
368 New Brooklyn Road
Berlin, NJ 08009
856-809-0142

4/10/2017 10:20 In:
Customer: 8638404 THE AMBIENT GROUP LLC
Order: 950949 Camden, NJ. ABC Barrel Project
P.O.:

Tkt. No. 1006028441



Product 114203
Bank Run
S.O. Info: Camden, NJ.
Ship Ref: 327 N. Front St

	Pounds	Kilo
Gross	76,840	34,854
Tare	27,300 *	12,383
Net	49,540	22,471
	24.77 Ton	22.47

* Predetermined Tare

	UNIT	TOTALS
Material:		
Freight:		
Tax:		
Fee / Fuel:		
Other Chrg: No		

Today Tons:	252.01	Loads:
Tons To Date:	16,725.06	10
Today Tonnes	228.62	
Tonnes To Date:	15,172.72	

By acceptance of this ticket (with or without signature), driver accepts on behalf of themselves/their employer sole responsibility to ensure that the load received is within the weight limit authorized by law and shall hold seller harmless against any and all claims with respect to same CURB DELIVERY ONLY. NOT RESPONSIBLE FOR ANY DAMAGE BEYOND CURB.

Carrier: 8040648 GJ SCOTT LLC
Vehicle: GS9 GS9
License: AK587X
MaxGVW: 80,000
Received: 
Weighmaster: Colleen LeSage

Cust: _____

P/D Status: Deliver

Customer Do Not Accept [1]

Scale: 1



Plant: 32411

Berlin

368 New Brooklyn Road
Berlin, NJ 08009
856-809-0142.

4/10/2017 10:24

In :

Customer: 8638404 THE AMBIENT GROUP LLC

Order : 950949 Camden, NJ. ABC Barrel Project

P.O. :

Tkt. No. 1006028442

Product 114203

Bank Run

S.O. Info: Camden, NJ.

Ship Ref: 327 N. Front St



	Pounds	Kilo
Gross	78,920	35,798
Tare	27,040 *	12,265
Net	51,880	23,532

25.94 Ton 23.53

* Predetermined Tare

	UNIT	TOTALS
Material:		
Freight:		
Tax:		
Fee / Fuel:		
Other Chrg: No		

Today Tons:	277.95	Loads:
Tons To Date:	16,751.00	11
Today Tonnes	252.15	
Tonnes To Date:	15,196.25	

Carrier : 8040648 GJ SCOTT LLC

Vehicle: GS6 GS6

License: AK761C

MaxGVW: 80,000

Received: _____

Weighmaster: Colleen LeSage

P/D Status: Deliver

Cust: _____

By acceptance of this ticket (with or without signature), driver accepts on behalf of themselves/their employer sole responsibility to ensure that the load received is within the weight limit authorized by law and shall hold seller harmless against any and all claims with respect to same CURB DELIVERY ONLY. NOT RESPONSIBLE FOR ANY DAMAGE BEYOND CURB.

Customer Copy

Scale: 1



Plant: 32411

Berlin

368 New Brooklyn Road
Berlin, NJ 08009
856-809-0142.

4/10/2017 10:31

In :

Customer: 8638404 THE AMBIENT GROUP LLC

Order : 950949 Camden, NJ. ABC Barrel Project

P.O. :

Tkt. No. 1006028443

Product 114203

Bank Run

S.O. Info: Camden, NJ.

Ship Ref: 327 N. Front St



	Pounds	Kilo
Gross	78,620	35,661
Tare	28,280 *	12,828
Net	50,340	22,834

25.17 Ton 22.83

* Predetermined Tare

	UNIT	TOTALS
Material:		
Freight:		
Tax:		
Fee / Fuel:		
Other Chrg: No		

Today Tons:	303.12	Loads:
Tons To Date:	16,776.17	12
Today Tonnes	274.99	
Tonnes To Date:	15,219.09	

Carrier : 8040648 GJ SCOTT LLC

Vehicle: GS17 GS17

License: AT640K

MaxGVW: 80,000

Received: _____

Weighmaster: Colleen LeSage

P/D Status: Deliver

Cust: _____

By acceptance of this ticket (with or without signature), driver accepts on behalf of themselves/their employer sole responsibility to ensure that the load received is within the weight limit authorized by law and shall hold seller harmless against any and all claims with respect to same CURB DELIVERY ONLY. NOT RESPONSIBLE FOR ANY DAMAGE BEYOND CURB.

Customer Copy

Scale: 1



Plant: 32411

Berlin

368 New Brooklyn Road
Berlin, NJ 08009
856-809-0142.

4/10/2017 10:34 In: 10:16:57
Customer: 8638404 THE AMBIENT GROUP LLC
Order : 950949 Camden, NJ. ABC Barrel Project
P.O. :

Tkt. No. 1006028444



Product 114203
Bank Run
S.O. Info: Camden, NJ.
Ship Ref: 327 N. Front St

	Pounds	Kilo
Gross	75,600	34,292
Tare	24,740	11,222
Net	50,860	23,070
	25.43 Ton	23.07

	UNIT	TOTALS
Material:		
Freight:		
Tax:		
Fee / Fuel:		
Other Chrg: No		

Today Tons:	328.55	Loads:
Tons To Date:	16,801.60	13
Today Tonnes	298.06	
Tonnes To Date:	15,242.16	

Carrier : 2347198 RAIO CONTRACTING & MATE
Vehicle: RO219 Raio
License: RO219
MaxGVW: 80,000
Received: _____
Weighmaster: Colleen LeSage
P/D Status: Deliver

By acceptance of this ticket (with or without signature), driver accepts on behalf of themselves/their employer sole responsibility to ensure that the load received is within the weight limit authorized by law and shall hold seller harmless against any and all claims with respect to same
CURB DELIVERY ONLY .NOT RESPONSIBLE FOR ANY DAMAGE BEYOND CURB.

Cust: _____

Customer Do Not Accept [1] Scale: 1



Plant: 32411

Berlin

368 New Brooklyn Road
Berlin, NJ 08009
856-809-0142.

4/10/2017 11:04 In:
Customer: 8638404 THE AMBIENT GROUP LLC
Order : 950949 Camden, NJ. ABC Barrel Project
P.O. :

Tkt. No. 1006028446



Product 114203
Bank Run
S.O. Info: Camden, NJ.
Ship Ref: 327 N. Front St

	Pounds	Kilo
Gross	74,540	33,811
Tare	26,740 *	12,129
Net	47,800	21,682
	23.90 Ton	21.68

* Predetermined Tare

	UNIT	TOTALS
Material:		
Freight:		
Tax:		
Fee / Fuel:		
Other Chrg: No		

Today Tons:	352.45	Loads:
Tons To Date:	16,825.50	14
Today Tonnes	319.74	
Tonnes To Date:	15,263.84	

Carrier : 2347198 RAIO CONTRACTING & MATE
Vehicle: RO215 Raio
License: AH264S
MaxGVW: 80,000
Received: T. Lewis
Weighmaster: Colleen LeSage
P/D Status: Deliver

By acceptance of this ticket (with or without signature), driver accepts on behalf of themselves/their employer sole responsibility to ensure that the load received is within the weight limit authorized by law and shall hold seller harmless against any and all claims with respect to same
CURB DELIVERY ONLY .NOT RESPONSIBLE FOR ANY DAMAGE BEYOND CURB.

Cust: _____

Customer Do Not Accept [1] Scale: 1



Plant: 32411

Berlin

368 New Brooklyn Road
Berlin, NJ 08009
856-809-0142

4/10/2017 11:06

In :

Customer: 8638404 THE AMBIENT GROUP LLC

Order : 950949 Camden, NJ. ABC Barrel Project

P.O. :

Tkt. No. 1006028447

Product 114203

Bank Run

S.O. Info: Camden, NJ.

Ship Ref: 327 N. Front St



	Pounds	Kilo
Gross	73,300	33,248
Tare	25,320 *	11,485
Net	47,980	21,763

23.99 Ton 21.76

* Predetermined Tare

Today Tons:	376.44	Loads:
Tons To Date:	16,849.49	15
Today Tonnes	341.50	
Tonnes To Date:	15,285.60	

By acceptance of this ticket (with or without signature), driver accepts on behalf of themselves/their employer sole responsibility to ensure that the load received is within the weight limit authorized by law and shall hold seller harmless against any and all claims with respect to same CURB DELIVERY ONLY .NOT RESPONSIBLE FOR ANY DAMAGE BEYOND CURB.

Material:	UNIT	TOTALS
Freight:		
Tax:		
Fee / Fuel:		
Other Chrg: No		

Carrier : 2347198 RAIO CONTRACTING & MATE

Vehicle: RO207 AT303G

License: AT303G

MaxGVW: 80,000

Received: _____ Cust: _____

Weighmaster: Colleen LeSage

P/D Status: Deliver

Customer Do Not Accept [3] Scale: 1



Plant: 32411

Berlin

368 New Brooklyn Road
Berlin, NJ 08009
856-809-0142

4/10/2017 11:29

In : 11:10:48

Customer: 8638404 THE AMBIENT GROUP LLC

Order : 950949 Camden, NJ. ABC Barrel Project

P.O. :

Tkt. No. 1006028448

Product 114203

Bank Run

S.O. Info: Camden, NJ.

Ship Ref: 327 N. Front St



	Pounds	Kilo
Gross	72,540	32,904
Tare	24,520	11,122
Net	48,020	21,782

24.01 Ton 21.78

Today Tons:	400.45	Loads:
Tons To Date:	16,873.50	16
Today Tonnes	363.28	
Tonnes To Date:	15,307.38	

By acceptance of this ticket (with or without signature), driver accepts on behalf of themselves/their employer sole responsibility to ensure that the load received is within the weight limit authorized by law and shall hold seller harmless against any and all claims with respect to same CURB DELIVERY ONLY .NOT RESPONSIBLE FOR ANY DAMAGE BEYOND CURB.

Material:	UNIT	TOTALS
Freight:		
Tax:		
Fee / Fuel:		
Other Chrg: No		

Carrier : 2347198 RAIO CONTRACTING & MATE

Vehicle: RO214 Raio

License: AH505N

MaxGVW: 80,000

Received: _____ Cust: _____

Weighmaster: Colleen LeSage

P/D Status: Deliver

Customer Do Not Accept [1] Scale: 1



Plant: 32411

Berlin

368 New Brooklyn Road
Berlin, NJ 08009
856-809-0142.

4/10/2017 11:39

In :

Customer: 8638404 THE AMBIENT GROUP LLC

Order : 950949 Camden, NJ. ABC Barrel Project

P.O. :

Tkt. No. 1006028449

Product 114203



Bank Run

S.O. Info: Camden, NJ.

Ship Ref: 327 N. Front St

	Pounds	Kilo
Gross	76,800	34,836
Tare	27,300 *	12,383
Net	49,500	22,453

24.75 Ton 22.45

* Predetermined Tare

	UNIT	TOTALS
Material:		
Freight:		
Tax:		
Fee / Fuel:		
Other Chrg: No		

Today Tons:	425.20	Loads:
Tons To Date:	16,898.25	17
Today Tonnes	385.73	
Tonnes To Date:	15,329.83	

By acceptance of this ticket (with or without signature), driver accepts, on behalf of themselves/their employer sole responsibility to ensure that the load received is within the weight limit authorized by law and shall hold seller harmless against any and all claims with respect to same CURB DELIVERY ONLY. NOT RESPONSIBLE FOR ANY DAMAGE BEYOND CURB.

Carrier : 8040648 GJ SCOTT LLC

Vehicle: GS9 GS9

License: AK587X

MaxGVW: 80,000

Received:

Cust: _____

Weighmaster: Colleen LeSage

P/D Status: Deliver

Customer Do Not Accept [1] Scale: 1



Plant: 32411

Berlin

368 New Brooklyn Road
Berlin, NJ 08009
856-809-0142.

4/10/2017 11:43

In :

Customer: 8638404 THE AMBIENT GROUP LLC

Order : 950949 Camden, NJ. ABC Barrel Project

P.O. :

Tkt. No. 1006028450

Product 114203



Bank Run

S.O. Info: Camden, NJ.

Ship Ref: 327 N. Front St

	Pounds	Kilo
Gross	71,480	32,423
Tare	27,040 *	12,265
Net	44,440	20,158

22.22 Ton 20.16

* Predetermined Tare

	UNIT	TOTALS
Material:		
Freight:		
Tax:		
Fee / Fuel:		
Other Chrg: No		

Today Tons:	447.42	Loads:
Tons To Date:	16,920.47	18
Today Tonnes	405.89	
Tonnes To Date:	15,349.99	

By acceptance of this ticket (with or without signature), driver accepts, on behalf of themselves/their employer sole responsibility to ensure that the load received is within the weight limit authorized by law and shall hold seller harmless against any and all claims with respect to same CURB DELIVERY ONLY. NOT RESPONSIBLE FOR ANY DAMAGE BEYOND CURB.

Carrier : 8040648 GJ SCOTT LLC

Vehicle: GS6 GS6

License: AK761C

MaxGVW: 80,000

Received:

Cust: _____

Weighmaster: Colleen LeSage

P/D Status: Deliver

Customer Copy Scale: 1



Plant: 32411

Berlin

368 New Brooklyn Road
Berlin, NJ 08009
856-809-0142

4/10/2017 11:45

In :

Customer: 8638404 THE AMBIENT GROUP LLC

Order : 950949 Camden, NJ. ABC Barrel Project

P.O. :

Tkt. No. 1006028451

Product 114203

Bank Run

S.O. Info: Camden, NJ.

Ship Ref: 327 N. Front St



	Pounds	Kilo
Gross	79,300	35,970
Tare	28,280 *	12,828
Net	51,020	23,142

25.51 Ton 23.14

* Predetermined Tare

	UNIT	TOTALS
Material:		
Freight:		
Tax:		
Fee / Fuel:		
Other Chrg: No		

Today Tons:	472.93	Loads:
Tons To Date:	16,945.98	19
Today Tonnes	429.03	
Tonnes To Date:	15,373.13	

Carrier : 8040648 GJ SCOTT LLC

Vehicle: GS17 GS17

License: AT640K

MaxGVW: 80,000

Received: _____

Cust: _____

Weighmaster: Colleen LeSage

P/D Status: Deliver

Customer Copy

Scale: 1

By acceptance of this ticket (with or without signature), driver accepts on behalf of themselves/their employer sole responsibility to ensure that the load received is within the weight limit authorized by law and shall hold seller harmless against any and all claims with respect to same CURB DELIVERY ONLY. NOT RESPONSIBLE FOR ANY DAMAGE BEYOND CURB.



Plant: 32411

Berlin

368 New Brooklyn Road
Berlin, NJ 08009
856-809-0142

4/10/2017 12:37

In :

Customer: 8638404 THE AMBIENT GROUP LLC

Order : 950949 Camden, NJ. ABC Barrel Project

P.O. :

Tkt. No. 1006028453

Product 114203

Bank Run

S.O. Info: Camden, NJ.

Ship Ref: 327 N. Front St



	Pounds	Kilo
Gross	75,800	34,382
Tare	26,740 *	12,129
Net	49,060	22,253

24.53 Ton 22.25

* Predetermined Tare

	UNIT	TOTALS
Material:		
Freight:		
Tax:		
Fee / Fuel:		
Other Chrg: No		

Today Tons:	497.46	Loads:
Tons To Date:	16,970.51	20
Today Tonnes	451.29	
Tonnes To Date:	15,395.39	

Carrier : 2347198 RAIO CONTRACTING & MATE

Vehicle: RO215 Raio

License: AH264S

MaxGVW: 80,000

Received: _____

Cust: _____

Weighmaster: Colleen LeSage

P/D Status: Deliver

Customer Copy

Scale: 1

By acceptance of this ticket (with or without signature), driver accepts on behalf of themselves/their employer sole responsibility to ensure that the load received is within the weight limit authorized by law and shall hold seller harmless against any and all claims with respect to same CURB DELIVERY ONLY. NOT RESPONSIBLE FOR ANY DAMAGE BEYOND CURB.



Plant: 32411

Berlin

368 New Brooklyn Road
Berlin, NJ 08009
856-809-0142

4/10/2017 12:39

In :
Customer: 8638404 THE AMBIENT GROUP LLC
Order : 950949 Camden, NJ. ABC Barrel Project
P.O. :

Tkt. No. 1006028454

Product 114203
Bank Run
S.O. Info: Camden, NJ.
Ship Ref: 327 N. Front St



	UNIT	TOTALS
Material:		
Freight:		
Tax:		
Fee / Fuel:		
Other Chrg:	No	

	Pounds	Kilo
Gross	75,100	34,065
Tare	25,320 *	11,485
Net	49,780	22,580
	24.89 Ton	22.58

* Predetermined Tare

Today Tons:	522.35	Loads:
Tons To Date:	16,995.40	21
Today Tonnes	473.87	
Tonnes To Date:	15,417.97	

Carrier: 2347198 RAIO CONTRACTING & MATE
Vehicle: RO207 AT303G
License: AT303G
MaxGVW: 80,000

By acceptance of this ticket (with or without signature), driver accepts on behalf of themselves/their employer sole responsibility to ensure that the load received is within the weight limit authorized by law and shall hold seller harmless against any and all claims with respect to same CURB DELIVERY ONLY. NOT RESPONSIBLE FOR ANY DAMAGE BEYOND CURB.

Received: _____ Cust: _____
Weighmaster: Colleen LeSage

P/D Status: Deliver

Customer Copy Scale: 1



Plant: 32411

Berlin

368 New Brooklyn Road
Berlin, NJ 08009
856-809-0142

4/10/2017 13:14

In :
Customer: 8638404 THE AMBIENT GROUP LLC
Order : 950949 Camden, NJ. ABC Barrel Project
P.O. :

Tkt. No. 1006028457

Product 114203
Bank Run
S.O. Info: Camden, NJ.
Ship Ref: 327 N. Front St



	UNIT	TOTALS
Material:		
Freight:		
Tax:		
Fee / Fuel:		
Other Chrg:	No	

	Pounds	Kilo
Gross	77,100	34,972
Tare	28,280 *	12,828
Net	48,820	22,144
	24.41 Ton	22.14

* Predetermined Tare

Today Tons:	546.76	Loads:
Tons To Date:	17,019.81	22
Today Tonnes	496.01	
Tonnes To Date:	15,440.11	

Carrier: 8040648 GJ SCOTT LLC
Vehicle: GS17 GS17
License: AT640K
MaxGVW: 80,000

By acceptance of this ticket (with or without signature), driver accepts on behalf of themselves/their employer sole responsibility to ensure that the load received is within the weight limit authorized by law and shall hold seller harmless against any and all claims with respect to same CURB DELIVERY ONLY. NOT RESPONSIBLE FOR ANY DAMAGE BEYOND CURB.

Received: _____ Cust: _____
Weighmaster: Colleen LeSage

P/D Status: Deliver

Customer Copy Scale: 1



Plant: 32411

Berlin

368 New Brooklyn Road
Berlin, NJ 08009
856-809-0142

4/10/2017 13:24

In :

Customer: 8638404 THE AMBIENT GROUP LLC

Order : 950949 Camden, NJ. ABC Barrel Project

P.O. :

Tkt No. 1006028459

Product 114203

Bank Run

S.O. Info: Camden, NJ.

Ship Ref: 327 N. Front St



	UNIT	TOTALS
Material:		
Freight:		
Tax:		
Fee / Fuel:		
Other Chrg: No		

	Pounds	Kilo
Gross	78,660	35,680
Tare	27,040 *	12,265
Net	51,620	23,414

25.81 Ton 23.41

* Predetermined Tare

Today Tons:	572.57	Loads:
Tons To Date:	17,045.62	23
Today Tonnes	519.43	
Tonnes To Date:	15,463.53	

By acceptance of this ticket (with or without signature), driver accepts on behalf of themselves/their employer sole responsibility to ensure that the load received is within the weight limit authorized by law and shall hold seller harmless against any and all claims with respect to same CURB DELIVERY ONLY. NOT RESPONSIBLE FOR ANY DAMAGE BEYOND CURB.

Carrier : 8040648 GJ SCOTT LLC

Vehicle: GS6 GS6

License: AK761C

MaxGVW: 80,000

Received: 

Weighmaster: Colleen LeSage

Cust: _____

P/D Status: Deliver

Customer Copy

Scale: 1



Plant: 32411

Berlin

368 New Brooklyn Road
Berlin, NJ 08009
856-809-0142

4/10/2017 13:29

In :

Customer: 8638404 THE AMBIENT GROUP LLC

Order : 950949 Camden, NJ. ABC Barrel Project

P.O. :

Tkt No. 1006028460

Product 114203

Bank Run

S.O. Info: Camden, NJ.

Ship Ref: 327 N. Front St



	UNIT	TOTALS
Material:		
Freight:		
Tax:		
Fee / Fuel:		
Other Chrg: No		

	Pounds	Kilo
Gross	77,040	34,945
Tare	27,300 *	12,383
Net	49,740	22,562

24.87 Ton 22.56

* Predetermined Tare

Today Tons:	597.44	Loads:
Tons To Date:	17,070.49	24
Today Tonnes	541.99	
Tonnes To Date:	15,486.09	

By acceptance of this ticket (with or without signature), driver accepts on behalf of themselves/their employer sole responsibility to ensure that the load received is within the weight limit authorized by law and shall hold seller harmless against any and all claims with respect to same CURB DELIVERY ONLY. NOT RESPONSIBLE FOR ANY DAMAGE BEYOND CURB.

Carrier : 8040648 GJ SCOTT LLC

Vehicle: GS9 GS9

License: AK587X

MaxGVW: 80,000

Received: 

Weighmaster: Colleen LeSage

Cust: _____

P/D Status: Deliver

Customer Copy

Scale: 1



Plant: 32411

Berlin

368 New Brooklyn Road
Berlin, NJ 08009
856-809-0142

4/11/2017 07:21 In: 6:45:01
Customer: 8638404 THE AMBIENT GROUP LLC
Order: 950949 Camden, NJ. ABC Barrel Project
P.O.:

Tkt. No. 1006028469

Product 114203
Bank Run
S.O. Info: Camden, NJ.
Ship Ref: 327 N. Front St



	Pounds	Kilo
Gross	79,980	36,278
Tare	28,360	12,864
Net	51,620	23,414
	25.81 Ton	23.41

	UNIT	TOTALS
Material:		
Freight:		
Tax:		
Fee / Fuel:		
Other Chrg: No		

Today Tons:	25.81	Loads:
Tons To Date:	17,096.30	1
Today Tonnes	23.41	
Tonnes To Date:	15,509.50	

By acceptance of this ticket (with or without signature), driver accepts on behalf of themselves/their employer sole responsibility to ensure that the load received is within the weight limit authorized by law and shall hold seller harmless against any and all claims with respect to same CURB DELIVERY ONLY. NOT RESPONSIBLE FOR ANY DAMAGE BEYOND CURB.

Carrier: 8040648 GJ SCOTT LLC
Vehicle: GS17 GS17
License: AT640K
MaxGVW: 80,000

Received: _____
Weighmaster: Colleen LeSage

Cust: _____

P/D Status: Deliver

Customer Copy

Scale: 1



Plant: 32411

Berlin

368 New Brooklyn Road
Berlin, NJ 08009
856-809-0142

4/11/2017 07:24 In: 6:46:08
Customer: 8638404 THE AMBIENT GROUP LLC
Order: 950949 Camden, NJ. ABC Barrel Project
P.O.:

Tkt. No. 1006028470

Product 114203
Bank Run
S.O. Info: Camden, NJ.
Ship Ref: 327 N. Front St



	Pounds	Kilo
Gross	78,940	35,807
Tare	27,140	12,310
Net	51,800	23,496
	25.90 Ton	23.50

	UNIT	TOTALS
Material:		
Freight:		
Tax:		
Fee / Fuel:		
Other Chrg: No		

Today Tons:	51.71	Loads:
Tons To Date:	17,122.20	2
Today Tonnes	46.91	
Tonnes To Date:	15,533.00	

By acceptance of this ticket (with or without signature), driver accepts on behalf of themselves/their employer sole responsibility to ensure that the load received is within the weight limit authorized by law and shall hold seller harmless against any and all claims with respect to same CURB DELIVERY ONLY. NOT RESPONSIBLE FOR ANY DAMAGE BEYOND CURB.

Carrier: 8040648 GJ SCOTT LLC
Vehicle: GS6 GS6
License: AK761C
MaxGVW: 80,000

Received: _____
Weighmaster: Colleen LeSage

Cust: _____

P/D Status: Deliver

Customer Copy

Scale: 1



Plant: 32411

Berlin

368 New Brooklyn Road
Berlin, NJ 08009
856-809-0142

4/11/2017 07:32

In: 6:46:30

Customer: 8638404 THE AMBIENT GROUP LLC

Order: 950949 Camden, NJ. ABC Barrel Project

P.O.:

Tkt. No. 1006028472

Product 114203

Bank Run

S.O. Info: Camden, NJ.

Ship Ref: 327 N. Front St



	Pounds	Kilo
Gross	78,760	35,725
Tare	28,740	13,036
Net	50,020	22,689

25.01 Ton 22.69

	UNIT	TOTALS
Material:		
Freight:		
Tax:		
Fee / Fuel:		
Other Chrg: No		

Today Tons:	76.72	Loads:
Tons To Date:	17,147.21	3
Today Tonnes	69.60	
Tonnes To Date:	15,555.69	

Carrier: 8040648 GJ SCOTT LLC

Vehicle: GS11 GS11

License: AN120Z

MaxGVW: 80,000

Received:

Weighmaster: Colleen LeSage

Cust: _____

By acceptance of this ticket (with or without signature), driver accepts on behalf of themselves/their employer sole responsibility to ensure that the load received is within the weight limit authorized by law and shall hold seller harmless against any and all claims with respect to same CURB DELIVERY ONLY. NOT RESPONSIBLE FOR ANY DAMAGE BEYOND CURB.

P/D Status: Deliver

Customer Copy

Scale: 1



Plant: 32411

Berlin

368 New Brooklyn Road
Berlin, NJ 08009
856-809-0142

4/11/2017 08:10

In: 7:35:25

Customer: 8638404 THE AMBIENT GROUP LLC

Order: 950949 Camden, NJ. ABC Barrel Project

P.O.:

Tkt. No. 1006028477

Product 114203

Bank Run

S.O. Info: Camden, NJ.

Ship Ref: 327 N. Front St



	Pounds	Kilo
Gross	71,160	32,278
Tare	23,380	10,605
Net	47,780	21,673

23.89 Ton 21.67

	UNIT	TOTALS
Material:		
Freight:		
Tax:		
Fee / Fuel:		
Other Chrg: No		

Today Tons:	100.61	Loads:
Tons To Date:	17,171.10	4
Today Tonnes	91.27	
Tonnes To Date:	15,577.36	

Carrier: 9285292 BLUESTONE CONTRACTING C

Vehicle: SB11 XDUX86

License: XDUX86

MaxGVW: 80,000

Received:

Weighmaster: Colleen LeSage

Cust: _____

By acceptance of this ticket (with or without signature), driver accepts on behalf of themselves/their employer sole responsibility to ensure that the load received is within the weight limit authorized by law and shall hold seller harmless against any and all claims with respect to same CURB DELIVERY ONLY. NOT RESPONSIBLE FOR ANY DAMAGE BEYOND CURB.

P/D Status: Deliver

Customer Do Not Accept [!]

Scale: 1



Plant: 32411

Berlin

368 New Brooklyn Road
Berlin, NJ 08009
856-809-0142

4/11/2017 09:15 In: 8:49:09
Customer: 8638404 THE AMBIENT GROUP LLC
Order: 950949 Camden, NJ. ABC Barrel Project
P.O.:

Tkt. No. 1006028485

Product 114203
Bank Run
S.O. Info: Camden, NJ.
Ship Ref: 327 N. Front St



	Pounds	Kilo
Gross	78,500	35,607
Tare	25,600	11,612
Net	52,900	23,995
	26.45 Ton	24.00

	UNIT	TOTALS
Material:		
Freight:		
Tax:		
Fee / Fuel:		
Other Chrg: No		

Today Tons:	127.06	Loads:
Tons To Date:	17,197.55	5
Today Tonnes	115.27	
Tonnes To Date:	15,601.35	

Carrier: 8647386 TURKEYROOST TRANSPORT
Vehicle: TUR001 Turkeyroost
License: AP182A
MaxGVW: 80,000
Received: _____
Weighmaster: Colleen LeSage

By acceptance of this ticket (with or without signature), driver accepts on behalf of themselves/their employer sole responsibility to ensure that the load received is within the weight limit authorized by law and shall hold seller harmless against any and all claims with respect to same
CURB DELIVERY ONLY. NOT RESPONSIBLE FOR ANY DAMAGE BEYOND CURB.

Cust: _____

P/D Status: Deliver

Customer Do Not Accept [1] Scale: 1



Plant: 32411

Berlin

368 New Brooklyn Road
Berlin, NJ 08009
856-809-0142

4/11/2017 09:18 In:
Customer: 8638404 THE AMBIENT GROUP LLC
Order: 950949 Camden, NJ. ABC Barrel Project
P.O.:

Tkt. No. 1006028486

Product 114203
Bank Run
S.O. Info: Camden, NJ.
Ship Ref: 327 N. Front St



	Pounds	Kilo
Gross	78,040	35,398
Tare	27,140 *	12,310
Net	50,900	23,088
	25.45 Ton	23.09

* Predetermined Tare

	UNIT	TOTALS
Material:		
Freight:		
Tax:		
Fee / Fuel:		
Other Chrg: No		

Today Tons:	152.51	Loads:
Tons To Date:	17,223.00	6
Today Tonnes	138.35	
Tonnes To Date:	15,624.44	

Carrier: 8040648 GJ SCOTT LLC
Vehicle: GS6 GS6
License: AK761C
MaxGVW: 80,000
Received: _____
Weighmaster: Colleen LeSage

By acceptance of this ticket (with or without signature), driver accepts on behalf of themselves/their employer sole responsibility to ensure that the load received is within the weight limit authorized by law and shall hold seller harmless against any and all claims with respect to same
CURB DELIVERY ONLY. NOT RESPONSIBLE FOR ANY DAMAGE BEYOND CURB.

Cust: _____

P/D Status: Deliver

Customer Do Not Accept [1] Scale: 1



Plant: 32411

Berlin

368 New Brooklyn Road
Berlin, NJ 08009
856-809-0142,

4/11/2017 09:22

In :

Customer: 8638404 THE AMBIENT GROUP LLC

Order : 950949 Camden, NJ. ABC Barrel Project

P.O. :

Tkt. No. 1006028487

Product 114203

Bank Run

S.O. Info: Camden, NJ

Ship Ref: 327 N. Front St



	Pounds	Kilo
Gross	79,420	36,024
Tare	28,740 *	13,036
Net	50,680	22,988

25.34 Ton 22.99

* Predetermined Tare

	UNIT	TOTALS
Material:		
Freight:		
Tax:		
Fee / Fuel:		
Other Chrg: No		

Today Tons:	177.85	Loads:
Tons To Date:	17,248.34	7
Today Tonnes	161.34	
Tonnes To Date:	15,647.43	

Carrier : 8040648 GJ SCOTT LLC

Vehicle: GS11 GS11

License: AN120Z

MaxGVW: 80,000

Received: _____

Cust: _____

Weighmaster: Colleen LeSage

P/D Status: Deliver

Customer Do Not Accept [1]

Scale: 1

By acceptance of this ticket (with or without signature), driver accepts on behalf of themselves/their employer sole responsibility to ensure that the load received is within the weight limit authorized by law and shall hold seller harmless against any and all claims with respect to same CURB DELIVERY ONLY. NOT RESPONSIBLE FOR ANY DAMAGE BEYOND CURB.



Plant: 32411

Berlin

368 New Brooklyn Road
Berlin, NJ 08009
856-809-0142,

4/11/2017 09:57

In : 9:07:49

Customer: 8638404 THE AMBIENT GROUP LLC

Order : 950949 Camden, NJ. ABC Barrel Project

P.O. :

Tkt. No. 1006028493

Product 114203

Bank Run

S.O. Info: Camden, NJ

Ship Ref: 327 N. Front St



	Pounds	Kilo
Gross	75,760	34,364
Tare	26,840	12,174
Net	48,920	22,190

24.46 Ton 22.19

	UNIT	TOTALS
Material:		
Freight:		
Tax:		
Fee / Fuel:		
Other Chrg: No		

Today Tons:	202.31	Loads:
Tons To Date:	17,272.80	8
Today Tonnes	183.53	
Tonnes To Date:	15,669.62	

Carrier : 2347631 R A DIMARIA

Vehicle: DY026 DiMaria

License: AS200U

MaxGVW: 80,000

Received: _____

Cust: _____

Weighmaster: Colleen LeSage

P/D Status: Deliver

Customer Copy

Scale: 1

By acceptance of this ticket (with or without signature), driver accepts on behalf of themselves/their employer sole responsibility to ensure that the load received is within the weight limit authorized by law and shall hold seller harmless against any and all claims with respect to same CURB DELIVERY ONLY. NOT RESPONSIBLE FOR ANY DAMAGE BEYOND CURB.



Plant: 32411

Berlin

368 New Brooklyn Road
Berlin, NJ 08009
856-809-0142.

4/11/2017 10:31

In :

Customer: 8638404 THE AMBIENT GROUP LLC

Order : 950949 Camden, NJ. ABC Barrel Project

P.O. :

Tkt. No. 1006028497

Product 114203

Bank Run

S.O. Info: Camden, NJ.

Ship Ref: 327 N. Front St



	Pounds	Kilo
Gross	78,040	35,398
Tare	23,380 *	10,605
Net	54,660	24,793

27.33 Ton 24.79

* Predetermined Tare

	UNIT	TOTALS
Material:		
Freight:		
Tax:		
Fee / Fuel:		
Other Chrg: No		

Today Tons:	229.64	Loads:
Tons To Date:	17,300.13	9
Today Tonnes	208.33	
Tonnes To Date:	15,694.41	

Carrier : 9285292 BLUESTONE CONTRACTING C

Vehicle: SB11 XDUX86

License: XDUX86

MaxGVW: 80,000

Received:

Weighmaster: Colleen LeSage

P/D Status: Deliver

By acceptance of this ticket (with or without signature), driver accepts on behalf of themselves/their employer sole responsibility to ensure that the load received is within the weight limit authorized by law and shall hold seller harmless against any and all claims with respect to same
CURB DELIVERY ONLY. NOT RESPONSIBLE FOR ANY DAMAGE BEYOND CURB.

Cust: _____

Customer Do Not Accept [H] Scale: 1



Plant: 32411

Berlin

368 New Brooklyn Road
Berlin, NJ 08009
856-809-0142.

4/11/2017 10:49

In :

Customer: 8638404 THE AMBIENT GROUP LLC

Order : 950949 Camden, NJ. ABC Barrel Project

P.O. :

Tkt. No. 1006028502

Product 114203

Bank Run

S.O. Info: Camden, NJ.

Ship Ref: 327 N. Front St



	Pounds	Kilo
Gross	78,980	35,825
Tare	28,740 *	13,036
Net	50,240	22,788

25.12 Ton 22.79

* Predetermined Tare

	UNIT	TOTALS
Material:		
Freight:		
Tax:		
Fee / Fuel:		
Other Chrg: No		

Today Tons:	254.76	Loads:
Tons To Date:	17,325.25	10
Today Tonnes	231.11	
Tonnes To Date:	15,717.20	

Carrier : 8040648 GJ SCOTT LLC

Vehicle: GS11 GS11

License: AN120Z

MaxGVW: 80,000

Received:

Weighmaster: Colleen LeSage

P/D Status: Deliver

By acceptance of this ticket (with or without signature), driver accepts on behalf of themselves/their employer sole responsibility to ensure that the load received is within the weight limit authorized by law and shall hold seller harmless against any and all claims with respect to same
CURB DELIVERY ONLY. NOT RESPONSIBLE FOR ANY DAMAGE BEYOND CURB.

Cust: _____

Customer Do Not Accept [H] Scale: 1



Plant: 32411

Berlin

368 New Brooklyn Road
Berlin, NJ 08009
856-809-0142,

4/11/2017 10:50

In :

Customer: 8638404 THE AMBIENT GROUP LLC

Order : 950949 Camden, NJ. ABC Barrel Project

P.O. :

Tkt. No. 1006028503

Product 114203

Bank Run

S.O. Info: Camden, NJ.

Ship Ref: 327 N. Front St



	Pounds	Kilo
Gross	78,700	35,698
Tare	27,140 *	12,310
Net	51,560	23,387

25.78 Ton 23.39

* Predetermined Tare

Today Tons:	280.54	Loads:
Tons To Date:	17,351.03	11
Today Tonnes	254.50	
Tonnes To Date:	15,740.59	

	UNIT	TOTALS
Material:		
Freight:		
Tax:		
Fee / Fuel:		
Other Chrg: No		

Carrier : 8040648 GJ SCOTT-LLC

Vehicle: GS6 GS6

License: AK761C

MaxGVW: 80,000

Received: 

Cust: _____

Weighmaster: Colleen LeSage

P/D Status: Deliver

Customer Copy

Scale: 1

By acceptance of this ticket (with or without signature), driver accepts on behalf of themselves/their employer sole responsibility to ensure that the load received is within the weight limit authorized by law and shall hold seller harmless against any and all claims with respect to same CURB DELIVERY ONLY. NOT RESPONSIBLE FOR ANY DAMAGE BEYOND CURB.



Plant: 32411

Berlin

368 New Brooklyn Road
Berlin, NJ 08009
856-809-0142,

4/11/2017 10:53

In :

Customer: 8638404 THE AMBIENT GROUP LLC

Order : 950949 Camden, NJ. ABC Barrel Project

P.O. :

Tkt. No. 1006028504

Product 114203

Bank Run

S.O. Info: Camden, NJ.

Ship Ref: 327 N. Front St



	Pounds	Kilo
Gross	79,920	36,251
Tare	25,600 *	11,612
Net	54,320	24,639

27.16 Ton 24.64

* Predetermined Tare

Today Tons:	307.70	Loads:
Tons To Date:	17,378.19	12
Today Tonnes	279.14	
Tonnes To Date:	15,765.23	

	UNIT	TOTALS
Material:		
Freight:		
Tax:		
Fee / Fuel:		
Other Chrg: No		

Carrier : 8647386 TURKEYROOST TRANSPORT

Vehicle: TUR001 Turkeyroost

License: AP182A

MaxGVW: 80,000

Received: _____

Cust: _____

Weighmaster: Colleen LeSage

P/D Status: Deliver

Customer Copy

Scale: 1

By acceptance of this ticket (with or without signature), driver accepts on behalf of themselves/their employer sole responsibility to ensure that the load received is within the weight limit authorized by law and shall hold seller harmless against any and all claims with respect to same CURB DELIVERY ONLY. NOT RESPONSIBLE FOR ANY DAMAGE BEYOND CURB.



Plant: 32411

Berlin

368 New Brooklyn Road
Berlin, NJ 08009
856-809-0142

4/11/2017 11:38 In: 10:22:38
Customer: 8638404 THE AMBIENT GROUP LLC
Order: 950949 Camden, NJ. ABC Barrel Project
P.O.:

Tkt. No. 1006028507

Product: 114203
Bank Run
S.O. Info: Camden, NJ.
Ship Ref: 327 N. Front St



	Pounds	Kilo
Gross	78,320	35,525
Tare	28,360	12,864
Net	49,960	22,661
	24.98 Ton	22.66

	UNIT	TOTALS
Material:		
Freight:		
Tax:		
Fee / Fuel:		
Other Chrg: No		

Today Tons:	332.68	Loads:
Tons To Date:	17,403.17	13
Today Tonnes	301.80	
Tonnes To Date:	15,787.89	

Carrier: 8040648 GJ SCOTT LLC
Vehicle: GS17 GS17
License: AT640K
MaxGVW: 80,000

By acceptance of this ticket (with or without signature), driver accepts on behalf of themselves/their employer sole responsibility to ensure that the load received is within the weight limit authorized by law and shall hold seller harmless against any and all claims with respect to same CURB DELIVERY ONLY. NOT RESPONSIBLE FOR ANY DAMAGE BEYOND CURB.

Received: _____
Weighmaster: Colleen LeSage

Cust: _____

P/D Status: Deliver

Customer Copy

Scale: 1



Plant: 32411

Berlin

368 New Brooklyn Road
Berlin, NJ 08009
856-809-0142

4/11/2017 11:45 In:
Customer: 8638404 THE AMBIENT GROUP LLC
Order: 950949 Camden, NJ. ABC Barrel Project
P.O.:

Tkt. No. 1006028509

Product: 114203
Bank Run
S.O. Info: Camden, NJ.
Ship Ref: 327 N. Front St



	Pounds	Kilo
Gross	75,640	34,310
Tare	26,840 *	12,174
Net	48,800	22,135
	24.40 Ton	22.14

* Predetermined Tare

	UNIT	TOTALS
Material:		
Freight:		
Tax:		
Fee / Fuel:		
Other Chrg: No		

Today Tons:	357.08	Loads:
Tons To Date:	17,427.57	14
Today Tonnes	323.94	
Tonnes To Date:	15,810.03	

Carrier: 2347631 R A DIMARIA
Vehicle: DY026 DiMaria
License: AS200U
MaxGVW: 80,000

By acceptance of this ticket (with or without signature), driver accepts on behalf of themselves/their employer sole responsibility to ensure that the load received is within the weight limit authorized by law and shall hold seller harmless against any and all claims with respect to same CURB DELIVERY ONLY. NOT RESPONSIBLE FOR ANY DAMAGE BEYOND CURB.

Received: _____
Weighmaster: Colleen LeSage

Cust: _____

P/D Status: Deliver

Customer Copy

Scale: 1



Plant: 32411

Berlin

368 New Brooklyn Road
Berlin, NJ 08009
856-809-0142

4/11/2017 12:31

In :

Customer: 8638404 THE AMBIENT GROUP LLC

Order : 950949 Camden, NJ. ABC Barrel Project

P.O. :

Tkt. No. 1006028515

Product 114203



Bank Run

S.O. Info: Camden, NJ.

Ship Ref: 327 N. Front St

	Pounds	Kilo
Gross	74,760	33,911
Tare	23,380 *	10,605
Net	51,380	23,306

25.69 Ton 23.31
* Predetermined Tare

	UNIT	TOTALS
Material:		
Freight:		
Tax:		
Fee / Fuel:		
Other Chrg: No		

Today Tons:	382.77	Loads:
Tons To Date:	17,453.26	15
Today Tonnes	347.24	
Tonnes To Date:	15,833.33	

Carrier : 9285292 BLUESTONE CONTRACTING C

Vehicle: SB11 XDUX86

License: XDUX86

MaxGVW: 80,000

Received:

Weighmaster: Colleen LeSage

P/D Status: Deliver

By acceptance of this ticket (with or without signature), driver accepts on behalf of themselves/their employer sole responsibility to ensure that the load received is within the weight limit authorized by law and shall hold seller harmless against any and all claims with respect to same CURB DELIVERY ONLY. NOT RESPONSIBLE FOR ANY DAMAGE BEYOND CURB.

Cust: _____

Customer Do Not Accept [1] Scale: 1



Plant: 32411

Berlin

368 New Brooklyn Road
Berlin, NJ 08009
856-809-0142

4/11/2017 12:36

In :

Customer: 8638404 THE AMBIENT GROUP LLC

Order : 950949 Camden, NJ. ABC Barrel Project

P.O. :

Tkt. No. 1006028516

Product 114203



Bank Run

S.O. Info: Camden, NJ.

Ship Ref: 327 N. Front St

	Pounds	Kilo
Gross	77,560	35,181
Tare	27,140 *	12,310
Net	50,420	22,870

25.21 Ton 22.87
* Predetermined Tare

	UNIT	TOTALS
Material:		
Freight:		
Tax:		
Fee / Fuel:		
Other Chrg: No		

Today Tons:	407.98	Loads:
Tons To Date:	17,478.47	16
Today Tonnes	370.11	
Tonnes To Date:	15,856.20	

Carrier : 8040648 GJ SCOTT LLC

Vehicle: GS6 GS6

License: AK761C

MaxGVW: 80,000

Received:

Weighmaster: Colleen LeSage

P/D Status: Deliver

By acceptance of this ticket (with or without signature), driver accepts on behalf of themselves/their employer sole responsibility to ensure that the load received is within the weight limit authorized by law and shall hold seller harmless against any and all claims with respect to same CURB DELIVERY ONLY. NOT RESPONSIBLE FOR ANY DAMAGE BEYOND CURB.

Cust: _____

Customer Do Not Accept [1] Scale: 1



Plant: 32411

Berlin

368 New Brooklyn Road
Berlin, NJ 08009
856-809-0142

4/11/2017 12:39 In :

Customer: 8638404 THE AMBIENT GROUP LLC

Order : 950949 Camden, NJ. ABC Barrel Project

P.O. :

Tkt. No. 1006028518



Product 114203

Bank Run

S.O. Info: Camden, NJ

Ship Ref: 327 N. Front St

	Pounds	Kilo
Gross	78,160	35,453
Tare	28,740 *	13,036
Net	49,420	22,417

24.71 Ton 22.42

* Predetermined Tare

Today Tons:	432.69	Loads:
Tons To Date:	17,503.18	17
Today Tonnes	392.53	
Tonnes To Date:	15,878.62	

By acceptance of this ticket (with or without signature), driver accepts on behalf of themselves/their employer sole responsibility to ensure that the load received is within the weight limit authorized by law and shall hold seller harmless against any and all claims with respect to same CURB DELIVERY ONLY. NOT RESPONSIBLE FOR ANY DAMAGE BEYOND CURB.

	UNIT	TOTALS
Material:		
Freight:		
Tax:		
Fee / Fuel:		
Other Chrg: No		

Carrier : 8040648 GJ SCOTT LLC

Vehicle: GS11 GS11

License: AN120Z

MaxGVW: 80,000

Received: _____

Cust: _____

Weighmaster: Colleen LeSage

P/D Status: Deliver

Customer Do Not Accept [1] Scale: 1



Plant: 32411

Berlin

368 New Brooklyn Road
Berlin, NJ 08009
856-809-0142

4/11/2017 12:52 In :

Customer: 8638404 THE AMBIENT GROUP LLC

Order : 950949 Camden, NJ. ABC Barrel Project

P.O. :

Tkt. No. 1006028521



Product 114203

Bank Run

S.O. Info: Camden, NJ

Ship Ref: 327 N. Front St

	Pounds	Kilo
Gross	79,600	36,106
Tare	28,360 *	12,864
Net	51,240	23,242

25.62 Ton 23.24

* Predetermined Tare

Today Tons:	458.31	Loads:
Tons To Date:	17,528.80	18
Today Tonnes	415.77	
Tonnes To Date:	15,901.86	

By acceptance of this ticket (with or without signature), driver accepts on behalf of themselves/their employer sole responsibility to ensure that the load received is within the weight limit authorized by law and shall hold seller harmless against any and all claims with respect to same CURB DELIVERY ONLY. NOT RESPONSIBLE FOR ANY DAMAGE BEYOND CURB.

	UNIT	TOTALS
Material:		
Freight:		
Tax:		
Fee / Fuel:		
Other Chrg: No		

Carrier : 8040648 GJ SCOTT LLC

Vehicle: GS17 GS17

License: AT640K

MaxGVW: 80,000

Received: _____

Cust: _____

Weighmaster: Colleen LeSage

P/D Status: Deliver

Customer Do Not Accept [1] Scale: 1



Plant: 32411

Berlin

368 New Brooklyn Road
Berlin, NJ 08009
856-809-0142

4/11/2017 13:57

In :

Customer: 8638404 THE AMBIENT GROUP LLC

Order : 950949 Camden, NJ. ABC Barrel Project

P.O. :

Tkt. No. 1006028527

Product 114203

Bank Run

S.O. Info: Camden, NJ.

Ship Ref: 327 N. Front St



	Pounds	Kilo
Gross	75,580	34,283
Tare	27,140 *	12,310
Net	48,440	21,972

24.22 Ton 21.97

* Predetermined Tare

Today Tons:	482.53	Loads:
Tons To Date:	17,553.02	19
Today Tonnes	437.74	
Tonnes To Date:	15,923.83	

	UNIT	TOTALS
Material:		
Freight:		
Tax:		
Fee / Fuel:		
Other Chrg: No		

Carrier : 8040648 GJ SCOTT LLC

Vehicle: GS6 GS6

License: AK761C

MaxGVW: 80,000

Received: _____

Weighmaster: Colleen LeSage

P/D Status: Deliver

By acceptance of this ticket (with or without signature), driver accepts on behalf of themselves/their employer sole responsibility to ensure that the load received is within the weight limit authorized by law and shall hold seller harmless against any and all claims with respect to same
CURB DELIVERY ONLY. NOT RESPONSIBLE FOR ANY DAMAGE BEYOND CURB.

Cust: _____

Customer Do Not Accept [1] Scale: 1



Plant: 32411

Berlin

368 New Brooklyn Road
Berlin, NJ 08009
856-809-0142

4/11/2017 14:03

In :

Customer: 8638404 THE AMBIENT GROUP LLC

Order : 950949 Camden, NJ. ABC Barrel Project

P.O. :

Tkt. No. 1006028528

Product 114203

Bank Run

S.O. Info: Camden, NJ.

Ship Ref: 327 N. Front St



	Pounds	Kilo
Gross	75,560	34,273
Tare	23,380 *	10,605
Net	52,180	23,668

26.09 Ton 23.67

* Predetermined Tare

Today Tons:	508.62	Loads:
Tons To Date:	17,579.11	20
Today Tonnes	461.41	
Tonnes To Date:	15,947.50	

	UNIT	TOTALS
Material:		
Freight:		
Tax:		
Fee / Fuel:		
Other Chrg: No		

Carrier : 9285292 BLUESTONE CONTRACTING C

Vehicle: SB11 XDUX86

License: XDUX86

MaxGVW: 80,000

Received: _____

Weighmaster: Colleen LeSage

P/D Status: Deliver

By acceptance of this ticket (with or without signature), driver accepts on behalf of themselves/their employer sole responsibility to ensure that the load received is within the weight limit authorized by law and shall hold seller harmless against any and all claims with respect to same
CURB DELIVERY ONLY. NOT RESPONSIBLE FOR ANY DAMAGE BEYOND CURB.

Cust: _____

Customer Copy Scale: 1



Plant: 32411

Berlin

368 New Brooklyn Road
Berlin, NJ 08009
856-809-0142

4/11/2017 14:07

In:

Customer: 8638404 THE AMBIENT GROUP LLC

Order: 950949 Camden, NJ. ABC Barrel Project

P.O.:

Tkt. No. 1006028529



Product 114203

Bank Run

S.O. Info: Camden, NJ

Ship Ref: 327 N. Front St

	Pounds	Kilo
Gross	77,560	35,181
Tare	28,740 *	13,036
Net	48,820	22,144

24.41 Ton 22.14

* Predetermined Tare

	UNIT	TOTALS
Material:		
Freight:		
Tax:		
Fee / Fuel:		
Other Chrg:	No	

Today Tons:	533.03	Loads:
Tons To Date:	17,603.52	21
Today Tonnes	483.56	
Tonnes To Date:	15,969.64	

Carrier: 8040648 GJ SCOTT LLC

Vehicle: GS11 GS11

License: AN120Z

MaxGVW: 80,000

Received: _____

Cust: _____

Weighmaster: Colleen LeSage

P/D Status: Deliver

By acceptance of this ticket (with or without signature), driver accepts on behalf of themselves/their employer sole responsibility to ensure that the load received is within the weight limit authorized by law and shall hold seller harmless against any and all claims with respect to same
CURB DELIVERY ONLY. NOT RESPONSIBLE FOR ANY DAMAGE BEYOND CURB.

Customer Copy

Scale: 1



Plant: 32411

Berlin

368 New Brooklyn Road
Berlin, NJ 08009
856-809-0142

4/17/2017 07:19

In: 6:37:46

Customer: 8638404

THE AMBIENT GROUP LLC

Order : 950949

Camden, NJ. ABC Barrel Project

Tkt. No. 1006028627

P.O. :

Product 114203



Bank Run

S.O. Info: Camden, NJ.

Ship Ref: 327 N. Front St

	Pounds	Kilo
Gross	79,360	35,997
Tare	28,620	12,982
Net	50,740	23,015

25.37 Ton 23.02

UNIT	TOTALS
Material:	
Freight:	
Tax:	
Fee / Fuel:	
Other Chrg: <u>No</u>	

Today Tons:	25.37	Loads:
Tons To Date:	17,628.89	1
Today Tonnes	23.02	
Tonnes To Date:	15,992.66	

Carrier : 8040648 GJ SCOTT LLC

Vehicle: GS11

GS11

License: AN120Z

MaxGVW: 80,000

Received: _____

Cust: _____

Weighmaster: Colleen LeSage

P/D Status: Deliver

Customer Do Not Accept [1]

Scale: 1

By acceptance of this ticket (with or without signature), driver accepts on behalf of themselves/their employer sole responsibility to ensure that the load received is within the weight limit authorized by law and shall hold seller harmless against any and all claims with respect to same CURB DELIVERY ONLY. NOT RESPONSIBLE FOR ANY DAMAGE BEYOND CURB.



Plant: 32411

Berlin

368 New Brooklyn Road
Berlin, NJ 08009
856-809-0142

4/17/2017 07:22

In: 6:38:08

Customer: 8638404

THE AMBIENT GROUP LLC

Order : 950949

Camden, NJ. ABC Barrel Project

Tkt. No. 1006028628

P.O. :

Product 114203



Bank Run

S.O. Info: Camden, NJ.

Ship Ref: 327 N. Front St

	Pounds	Kilo
Gross	77,800	35,289
Tare	28,240	12,809
Net	49,560	22,480

24.78 Ton 22.48

UNIT	TOTALS
Material:	
Freight:	
Tax:	
Fee / Fuel:	
Other Chrg: <u>No</u>	

Today Tons:	50.15	Loads:
Tons To Date:	17,653.67	2
Today Tonnes	45.50	
Tonnes To Date:	16,015.14	

Carrier : 8040648 GJ SCOTT LLC

Vehicle: GS17

GS17

License: AT640K

MaxGVW: 80,000

Received: _____

Cust: _____

Weighmaster: Colleen LeSage

P/D Status: Deliver

Customer Copy

Scale: 1

By acceptance of this ticket (with or without signature), driver accepts on behalf of themselves/their employer sole responsibility to ensure that the load received is within the weight limit authorized by law and shall hold seller harmless against any and all claims with respect to same CURB DELIVERY ONLY. NOT RESPONSIBLE FOR ANY DAMAGE BEYOND CURB.



Plant: 32411

Berlin

368 New Brooklyn Road
Berlin, NJ 08009
856-809-0142.

4/17/2017 08:51

In :

Customer: 8638404 THE AMBIENT GROUP LLC

Order : 950949 Camden, NJ. ABC Barrel Project

P.O. :

Tkt. No. 1006028642

Product 114203



Bank Run

S.O. Info: Camden, NJ.

Ship Ref: 327 N. Front St

	Pounds	Kilo
Gross	78,400	35,562
Tare	28,620 *	12,982
Net	49,780	22,580

24.89 Ton 22.58

* Predetermined Tare

	UNIT	TOTALS
Material:		
Freight:		
Tax:		
Fee / Fuel:		
Other Chrg: No		

Today Tons:	75.04	Loads:
Tons To Date:	17,678.56	3
Today Tonnes	68.08	
Tonnes To Date:	16,037.72	

Carrier : 8040648 GJ SCOTT LLC

Vehicle: GS11 GS11

License: AN120Z

MaxGVW: 80,000

Received: _____

Cust: _____

Weighmaster: Colleen LeSage

P/D Status: Deliver

Customer Do Not Accept [1] Scale: 1

By acceptance of this ticket (with or without signature), driver accepts on behalf of themselves/their employer sole responsibility to ensure that the load received is within the weight limit authorized by law and shall hold seller harmless against any and all claims with respect to same
CURB DELIVERY ONLY. NOT RESPONSIBLE FOR ANY DAMAGE BEYOND CURB.



Plant: 32411

Berlin

368 New Brooklyn Road
Berlin, NJ 08009
856-809-0142.

4/17/2017 08:55

In :

Customer: 8638404 THE AMBIENT GROUP LLC

Order : 950949 Camden, NJ. ABC Barrel Project

P.O. :

Tkt. No. 1006028644

Product 114203



Bank Run

S.O. Info: Camden, NJ.

Ship Ref: 327 N. Front St

	Pounds	Kilo
Gross	77,340	35,081
Tare	28,240 *	12,809
Net	49,100	22,271

24.55 Ton 22.27

* Predetermined Tare

	UNIT	TOTALS
Material:		
Freight:		
Tax:		
Fee / Fuel:		
Other Chrg: No		

Today Tons:	99.59	Loads:
Tons To Date:	17,703.11	4
Today Tonnes	90.35	
Tonnes To Date:	16,059.99	

Carrier : 8040648 GJ SCOTT LLC

Vehicle: GS17 GS17

License: AT640K

MaxGVW: 80,000

Received: _____

Cust: _____

Weighmaster: Colleen LeSage

P/D Status: Deliver

Customer Copy Scale: 1

By acceptance of this ticket (with or without signature), driver accepts on behalf of themselves/their employer sole responsibility to ensure that the load received is within the weight limit authorized by law and shall hold seller harmless against any and all claims with respect to same
CURB DELIVERY ONLY. NOT RESPONSIBLE FOR ANY DAMAGE BEYOND CURB.



Plant: 32411

Berlin

368 New Brooklyn Road
Berlin, NJ 08009
856-809-0142

4/17/2017 10:17

In :

Customer: 8638404 THE AMBIENT GROUP LLC

Order : 950949 Camden, NJ. ABC Barrel Project

P.O. :

Tkt. No. 1006028651

Product 114203

Bank Run

S.O. Info: Camden, NJ.

Ship Ref: 327 N. Front St



	Pounds	Kilo
Gross	79,440	36,033
Tare	28,240 *	12,809
Net	51,200	23,224

25.60 Ton 23.22

* Predetermined Tare

	UNIT	TOTALS
Material:		
Freight:		
Tax:		
Fee / Fuel:		
Other Chrg: No		

Today Tons:	125.19	Loads:
Tons To Date:	17,728.71	5
Today Tonnes	113.57	
Tonnes To Date:	16,083.22	

Carrier : 8040648 GJ SCOTT LLC

Vehicle: GS17 GS17

License: AT640K

MaxGVW: 80,000

Received: _____

Weighmaster: Colleen LeSage

Cust: _____

P/D Status: Deliver

By acceptance of this ticket (with or without signature), driver accepts on behalf of themselves/their employer sole responsibility to ensure that the load received is within the weight limit authorized by law and shall hold seller harmless against any and all claims with respect to same
CURB DELIVERY ONLY. NOT RESPONSIBLE FOR ANY DAMAGE BEYOND CURB.

Customer Copy

Scale: 1



Plant: 32411

Berlin

368 New Brooklyn Road
Berlin, NJ 08009
856-809-0142

4/17/2017 10:23

In :

Customer: 8638404 THE AMBIENT GROUP LLC

Order : 950949 Camden, NJ. ABC Barrel Project

P.O. :

Tkt. No. 1006028652

Product 114203

Bank Run

S.O. Info: Camden, NJ.

Ship Ref: 327 N. Front St



	Pounds	Kilo
Gross	78,980	35,825
Tare	28,620 *	12,982
Net	50,360	22,843

25.18 Ton 22.84

* Predetermined Tare

	UNIT	TOTALS
Material:		
Freight:		
Tax:		
Fee / Fuel:		
Other Chrg: No		

Today Tons:	150.37	Loads:
Tons To Date:	17,753.89	6
Today Tonnes	136.41	
Tonnes To Date:	16,106.06	

Carrier : 8040648 GJ SCOTT LLC

Vehicle: GS11 GS11

License: AN120Z

MaxGVW: 80,000

Received: _____

Weighmaster: Colleen LeSage

Cust: _____

P/D Status: Deliver

By acceptance of this ticket (with or without signature), driver accepts on behalf of themselves/their employer sole responsibility to ensure that the load received is within the weight limit authorized by law and shall hold seller harmless against any and all claims with respect to same
CURB DELIVERY ONLY. NOT RESPONSIBLE FOR ANY DAMAGE BEYOND CURB.

Customer Do Not Accept [1]

Scale: 1



Plant: 32411

Berlin

368 New Brooklyn Road
Berlin, NJ 08009
856-809-0142

4/17/2017 11:45

In :

Customer: 8638404 THE AMBIENT GROUP LLC

Order : 950949 Camden, NJ. ABC Barrel Project

P.O. :

Tkt. No. 1006028659

Product 114203

Bank Run

S.O. Info: Camden, NJ.

Ship Ref: 327 N. Front St



	Pounds	Kilo
Gross	78,040	35,398
Tare	28,240 *	12,809
Net	49,800	22,589

24.90 Ton 22.59

* Predetermined Tare

Today Tons:	175.27	Loads:
Tons To Date:	17,778.79	7
Today Tonnes	159.00	
Tonnes To Date:	16,128.65	

	UNIT	TOTALS
Material:		
Freight:		
Tax:		
Fee / Fuel:		
Other Chrg: No		

Carrier : 8040648 GJ SCOTT LLC

Vehicle: GS17 GS17

License: AT640K

MaxGVW: 80,000

Received: _____

Cust: _____

Weighmaster: Colleen LeSage

P/D Status: Deliver

Customer Copy

Scale: 1

By acceptance of this ticket (with or without signature), driver accepts on behalf of themselves/their employer sole responsibility to ensure that the load received is within the weight limit authorized by law and shall hold seller harmless against any and all claims with respect to same CURB DELIVERY ONLY. NOT RESPONSIBLE FOR ANY DAMAGE BEYOND CURB.



Plant: 32411

Berlin

368 New Brooklyn Road
Berlin, NJ 08009
856-809-0142

4/17/2017 11:59

In :

Customer: 8638404 THE AMBIENT GROUP LLC

Order : 950949 Camden, NJ. ABC Barrel Project

P.O. :

Tkt. No. 1006028662

Product 114203

Bank Run

S.O. Info: Camden, NJ.

Ship Ref: 327 N. Front St



	Pounds	Kilo
Gross	77,600	35,199
Tare	28,620 *	12,982
Net	48,980	22,217

24.49 Ton 22.22

* Predetermined Tare

Today Tons:	199.76	Loads:
Tons To Date:	17,803.28	8
Today Tonnes	181.22	
Tonnes To Date:	16,150.86	

	UNIT	TOTALS
Material:		
Freight:		
Tax:		
Fee / Fuel:		
Other Chrg: No		

Carrier : 8040648 GJ SCOTT LLC

Vehicle: GS11 GS11

License: AN120Z

MaxGVW: 80,000

Received: _____

Cust: _____

Weighmaster: Colleen LeSage

P/D Status: Deliver

Customer Do Not Accept [1]

Scale: 1

By acceptance of this ticket (with or without signature), driver accepts on behalf of themselves/their employer sole responsibility to ensure that the load received is within the weight limit authorized by law and shall hold seller harmless against any and all claims with respect to same CURB DELIVERY ONLY. NOT RESPONSIBLE FOR ANY DAMAGE BEYOND CURB.



Plant: 32411

Berlin

368 New Brooklyn Road
Berlin, NJ 08009
856-809-0142,

4/17/2017 13:06

In :

Customer: 8638404 THE AMBIENT GROUP LLC

Order : 950949 Camden, NJ. ABC Barrel Project

P.O. :

Tkt. No. 1006028673



Product 114203

Bank Run

S.O. Info: Camden, NJ.

Ship Ref: 327 N. Front St

	Pounds	Kilo
Gross	79,960	36,269
Tare	28,240 *	12,809
Net	51,720	23,460

25.86 Ton 23.46

* Predetermined Tare

	UNIT	TOTALS
Material:		
Freight:		
Tax:		
Fee / Fuel:		
Other Chrg: No		

Today Tons:	225.62	Loads:
Tons To Date:	17,829.14	9
Today Tonnes	204.68	
Tonnes To Date:	16,174.32	

Carrier : 8040648 GJ SCOTT LLC

Vehicle: GS17 GS17

License: AT640K

MaxGVW: 80,000

Received: _____

Cust: _____

Weighmaster: Colleen LeSage

P/D Status: Deliver

Customer Copy

Scale: 1

By acceptance of this ticket (with or without signature), driver accepts on behalf of themselves/their employer sole responsibility to ensure that the load received is within the weight limit authorized by law and shall hold seller harmless against any and all claims with respect to same CURB DELIVERY ONLY. NOT RESPONSIBLE FOR ANY DAMAGE BEYOND CURB.



Plant: 32411

Berlin

368 New Brooklyn Road
Berlin, NJ 08009
856-809-0142,

4/17/2017 13:35

In :

Customer: 8638404 THE AMBIENT GROUP LLC

Order : 950949 Camden, NJ. ABC Barrel Project

P.O. :

Tkt. No. 1006028677



Product 114203

Bank Run

S.O. Info: Camden, NJ.

Ship Ref: 327 N. Front St

	Pounds	Kilo
Gross	78,580	35,643
Tare	28,620 *	12,982
Net	49,960	22,661

24.98 Ton 22.66

* Predetermined Tare

	UNIT	TOTALS
Material:		
Freight:		
Tax:		
Fee / Fuel:		
Other Chrg: No		

Today Tons:	250.60	Loads:
Tons To Date:	17,854.12	10
Today Tonnes	227.34	
Tonnes To Date:	16,196.99	

Carrier : 8040648 GJ SCOTT LLC

Vehicle: GS11 GS11

License: AN120Z

MaxGVW: 80,000

Received: _____

Cust: _____

Weighmaster: Colleen LeSage

P/D Status: Deliver

Customer Do Not Accept [1]

Scale: 1

By acceptance of this ticket (with or without signature), driver accepts on behalf of themselves/their employer sole responsibility to ensure that the load received is within the weight limit authorized by law and shall hold seller harmless against any and all claims with respect to same CURB DELIVERY ONLY. NOT RESPONSIBLE FOR ANY DAMAGE BEYOND CURB.



Plant: 32411

Berlin

368 New Brooklyn Road
Berlin, NJ 08009
856-809-0142

4/20/2017 07:50 In: 7:31:09
Customer: 8638404 THE AMBIENT GROUP LLC
Order : 950949 Camden, NJ. ABC Barrel Project
P.O. :

Tkt. No. 1006028782

Product 114203
Bank Run
S.O. Info: Camden, NJ.
Ship Ref: 327 N. Front St



	Pounds	Kilo
Gross	74,760	33,911
Tare	24,820	11,258
Net	49,940	22,652

24.97 Ton 22.65

	UNIT	TOTALS
Material:		
Freight:		
Tax:		
Fee / Fuel:		
Other Chrg: No		

Today Tons:	24.97	Loads:
Tons To Date:	17,879.09	1
Today Tonnes	22.65	
Tonnes To Date:	16,219.64	

By acceptance of this ticket (with or without signature), driver accepts on behalf of themselves/their employer sole responsibility to ensure that the load received is within the weight limit authorized by law and shall hold seller harmless against any and all claims with respect to same CURB DELIVERY ONLY. NOT RESPONSIBLE FOR ANY DAMAGE BEYOND CURB.

Carrier : 2347198 RAIO CONTRACTING & MATE
Vehicle: RO214 Raio
License: AH505N
Max GVW: 80,000
Received: 2214
Weighmaster: Colleen LeSage

Cust: _____

P/D Status: Deliver

Customer Copy

Scale: 1



Plant: 32411

Berlin

368 New Brooklyn Road
Berlin, NJ 08009
856-809-0142

4/20/2017 09:23 In:
Customer: 8638404 THE AMBIENT GROUP LLC
Order : 950949 Camden, NJ. ABC Barrel Project
P.O. :

Tkt. No. 1006028787

Product 114203
Bank Run
S.O. Info: Camden, NJ.
Ship Ref: 327 N. Front St



	Pounds	Kilo
Gross	74,420	33,756
Tare	24,820 *	11,258
Net	49,600	22,498

24.80 Ton 22.50

* Predetermined Tare

	UNIT	TOTALS
Material:		
Freight:		
Tax:		
Fee / Fuel:		
Other Chrg: No		

Today Tons:	49.77	Loads:
Tons To Date:	17,903.89	2
Today Tonnes	45.15	
Tonnes To Date:	16,242.14	

By acceptance of this ticket (with or without signature), driver accepts on behalf of themselves/their employer sole responsibility to ensure that the load received is within the weight limit authorized by law and shall hold seller harmless against any and all claims with respect to same CURB DELIVERY ONLY. NOT RESPONSIBLE FOR ANY DAMAGE BEYOND CURB.

Carrier : 2347198 RAIO CONTRACTING & MATE
Vehicle: RO214 Raio
License: AH505N
Max GVW: 80,000
Received: 2214
Weighmaster: Colleen LeSage

Cust: _____

P/D Status: Deliver

Customer Copy

Scale: 1

4/20/2017 10:04 In: 9:43:47
Customer: 8638404 THE AMBIENT GROUP LLC
Order: 950949 Camden, NJ. ABC Barrel Project
P.O.:**Tkt. No. 1006028789**Product 114203
Bank Run
S.O. Info: Camden, NJ.
Ship Ref: 327 N. Front St

	Pounds	Kilo
Gross	77,560	35,181
Tare	27,820	12,619
Net	49,740	22,562
	24.87 Ton	22.56

	UNIT	TOTALS
Material:		
Freight:		
Tax:		
Fee / Fuel:		
Other Chrg: <u>No</u>		

Today Tons:	74.64	Loads:	
Tons To Date:	17,928.76		3
Today Tonnes	67.71		
Tonnes To Date:	16,264.70		

Carrier: 2347198 RAIO CONTRACTING & MATE
Vehicle: RO208 AG820E
License: **AG820E**
MaxGVW: 80,000
Received: *D. Russo*
Weighmaster: Colleen LeSage*By acceptance of this ticket (with or without signature), driver accepts on behalf of themselves/their employer sole responsibility to ensure that the load received is within the weight limit authorized by law and shall hold seller harmless against any and all claims with respect to same CURB DELIVERY ONLY. NOT RESPONSIBLE FOR ANY DAMAGE BEYOND CURB.*

Cust: _____

P/D Status: **Deliver**

Customer Do Not Accept [2] Scale: 1

**Camden Redevelopment
Agency (CRA)
ABC Barrel Site
Remediation and Harrison
Ave. Landfill Interim
Closure**

TOPSOIL

Beneficial Soil/SLF Topsoil, Pedricktown, NJ



March 8, 2017

Prepared For:

**Camden Redevelopment
Agency (CRA)**

**520 Market Street, Suite 1300
Camden, NJ 08101**

Prepared By:

The Ambient Group, LLC.

**222 Thies Road
Sewell, NJ 08080
856-582-1765**

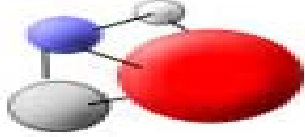

Mid-Atlantic Environmental Laboratories, Inc.

30 Lukens Drive, Suite A
 New Castle, DE 19720
 Phone: 302-654-1340 Fax: 302-654-1058
 mael@midatlanticenvlabs.com
 www.midatlanticenvlabs.com

SUMMARY REPORT

Client: Beneficial Soil Solutions
Project Name: SLF Topsoil
Lab Job No.: 46141

NJDEP Soil Remediation Standards			
Residential Direct Contact Standard	Non-Residential Direct Contact Standard	Impact To Ground Water Standard	Compared Standard

Client ID:	
Lab ID:	46141-1
Date Sampled:	11/07/2016
Matrix:	Soil

Aroclors (mg/kg)							PQL	Result
12674-11-2	Aroclor-1016	TRG	0.2	1	0.2	0.2	0.025	ND
11104-28-2	Aroclor-1221	TRG	0.2	1	0.2	0.2	0.025	ND
11141-16-5	Aroclor-1232	TRG	0.2	1	0.2	0.2	0.025	ND
53469-21-9	Aroclor-1242	TRG	0.2	1	0.2	0.2	0.025	ND
12672-29-6	Aroclor-1248	TRG	0.2	1	0.2	0.2	0.025	ND
11097-69-1	Aroclor-1254	TRG	0.2	1	0.2	0.2	0.025	ND
11096-82-5	Aroclor-1260	TRG	0.2	1	0.2	0.2	0.025	ND
General Chemistry (mg/kg)							PQL	Result
18540-29-9	Chromium, Hexavalent	TRG	240	20	s spec.	20	1.00	ND
57-12-5	Cyanide	TRG	1600	23000	20	20	0.20	0.68
Pesticides (mg/kg)							PQL	Result
72-54-8	4,4'-DDD	TRG	3	13	4	3	0.00250	ND
72-55-9	4,4'-DDE	TRG	2	9	18	2	0.00250	ND
50-29-3	4,4'-DDT	TRG	2	8	11	2	0.00250	ND
309-00-2	Aldrin	TRG	0.04	0.2	0.2	0.04	0.00125	ND
319-84-6	alpha-BHC	TRG	0.1	0.5	0.002	0.002	0.00125	ND
319-85-7	beta-BHC	TRG	0.4	2	0.002	0.002	0.00125	ND
57-74-9	Chlordane	TRG	0.2	1	0.05	0.05	0.00250	ND
60-57-1	Dieldrin	TRG	0.04	0.2	0.003	0.003	0.00250	ND
959-98-8	Endosulfan I	TRG	470	6800	4	4	0.00125	ND
33213-65-9	Endosulfan II	TRG	470	6800	4	4	0.00250	ND
1031-07-8	Endosulfan sulfate	TRG	470	6800	2	2	0.00250	ND
72-20-8	Endrin	TRG	23	340	1	1	0.00250	ND
58-89-9	gamma-BHC (Lindane)	TRG	0.4	2	0.002	0.002	0.00125	ND
76-44-8	Heptachlor	TRG	0.1	0.7	0.5	0.1	0.00125	ND
1024-57-3	Heptachlor Epoxide	TRG	0.07	0.3	0.01	0.01	0.00125	ND
72-43-5	Methoxychlor	TRG	390	5700	160	160	0.01250	ND

8001-35-2	Toxaphene	TRG	0.6	3	0.3	0.3	0.02500	ND
Semivolatile Organics - GC/MS (mg/kg)							PQL	Result
122-66-7	1,2-Diphenylhydrazine	TRG	0.7	2	0.7	0.7	0.100	ND
95-95-4	2,4,5-Trichlorophenol	TRG	6100	68000	68	68	0.100	ND
88-06-2	2,4,6-Trichlorophenol	TRG	19	74	0.2	0.2	0.100	ND
120-83-2	2,4-Dichlorophenol	TRG	180	2100	0.2	0.2	0.100	ND
105-67-9	2,4-Dimethylphenol	TRG	1200	14000	1	1	0.100	ND
51-28-5	2,4-Dinitrophenol	TRG	120	1400	0.3	0.3	0.250	ND
121-14-2	2,4-Dinitrotoluene	TRG	0.7	3	0.2	0.2	0.100	ND
606-20-2	2,6-Dinitrotoluene	TRG	0.7	3	0.2	0.2	0.100	ND
95-57-8	2-Chlorophenol	TRG	310	2200	0.8	0.8	0.100	ND
91-57-6	2-Methylnaphthalene	TRG	230	2400	8	8	0.100	ND
95-48-7	2-Methylphenol	TRG	310	3400	NA	310	0.100	ND
88-74-4	2-Nitroaniline	TRG	39	23000	NA	39	0.100	ND
88-75-5	2-Nitrophenol	TRG	NA	NA	NA	NA	0.100	ND
106-44-5	3+4-Methylphenol	TRG	31	340	NA	31	0.100	ND
91-94-1	3,3'-Dichlorobenzidine	TRG	1	4	0.2	0.2	0.200	ND
99-09-2	3-Nitroaniline	TRG	NA	NA	NA	NA	0.100	ND
534-52-1	4,6-Dinitro-2-methylphenol	TRG	6	68	0.3	0.3	0.100	ND
83-32-9	Acenaphthene	TRG	3400	37000	110	110	0.100	ND
208-96-8	Acenaphthylene	TRG	NA	300000	NA	300000	0.100	ND
98-86-2	Acetophenone	TRG	2	5	3	2	0.100	ND
120-12-7	Anthracene	TRG	17000	30000	2400	2400	0.100	ND
1912-24-9	Atrazine	TRG	210	2400	0.2	0.2	0.100	ND
100-52-7	Benzaldehyde	TRG	6100	68000	NA	6100	0.100	ND
92-87-5	Benzidine	TRG	0.7	0.7	0.7	0.7	0.200	ND
56-55-3	Benzo(a)anthracene	TRG	0.6	2	0.8	0.6	0.100	ND
50-32-8	Benzo(a)pyrene	TRG	0.2	0.2	0.2	0.2	0.100	ND
205-99-2	Benzo(b)fluoranthene	TRG	0.6	2	2	0.6	0.100	ND
191-24-2	Benzo(g,h,i)perylene	TRG	380000	30000	NA	30000	0.100	ND
207-08-9	Benzo(k)fluoranthene	TRG	6	23	25	6	0.100	ND
100-51-6	Benzyl alcohol	TRG	NA	NA	NA	NA	0.100	ND
92-52-4	Biphenyl	TRG	3100	34000	140	140	0.100	ND
111-91-1	bis(2-chloroethoxy)methane	TRG	NA	NA	NA	NA	0.100	ND
111-44-4	bis(2-chloroethyl)ether	TRG	0.4	2	0.2	0.2	0.100	ND
108-60-1	bis(2-chloroisopropyl)ether	TRG	23	67	5	5	0.100	ND
117-81-7	bis(2-ethylhexyl)phthalate	TRG	35	140	1200	35	0.100	ND
85-68-7	Butylbenzylphthalate	TRG	1200	14000	230	230	0.100	ND
105-60-2	Caprolactam	TRG	31000	340000	12	12	0.100	ND
86-74-8	Carbazole	TRG	24	96	NA	24	0.100	ND
218-01-9	Chrysene	TRG	62	230	80	62	0.100	ND
84-74-2	Di-n-butylphthalate	TRG	6100	68000	760	760	0.100	ND
117-84-0	Di-n-octylphthalate	TRG	2400	27000	3300	2400	0.100	ND
53-70-3	Dibenzo(a,h)anthracene	TRG	0.2	0.2	0.8	0.2	0.100	ND
84-66-2	Diethylphthalate	TRG	49000	550000	88	88	0.100	ND
206-44-0	Fluoranthene	TRG	2300	24000	1300	1300	0.100	ND
86-73-7	Fluorene	TRG	2300	24000	170	170	0.100	ND
118-74-1	Hexachlorobenzene	TRG	0.3	1	0.2	0.2	0.100	ND
87-68-3	Hexachlorobutadiene	TRG	6	25	0.9	0.9	0.100	ND

77-47-4	Hexachlorocyclopentadiene	TRG	45	110	320	45	0.250	ND
67-72-1	Hexachloroethane	TRG	35	140	0.2	0.2	0.100	ND
193-39-5	Indeno(1,2,3-cd)pyrene	TRG	0.6	2	7	0.6	0.100	ND
78-59-1	Isophorone	TRG	510	2000	0.2	0.2	0.100	ND
621-64-7	n-Nitroso-di-n-propylamine	TRG	0.2	0.3	0.2	0.2	0.100	ND
86-30-6	n-Nitrosodiphenylamine	TRG	99	390	0.4	0.4	0.100	ND
91-20-3	Naphthalene	TRG	6	17	25	6	0.100	ND
98-95-3	Nitrobenzene	TRG	31	340	0.2	0.2	0.100	ND
87-86-5	Pentachlorophenol	TRG	3	10	0.3	0.3	0.100	ND
85-01-8	Phenanthrene	TRG	NA	300000	NA	300000	0.100	ND
108-95-2	Phenol	TRG	18000	210000	8	8	0.100	ND
129-00-0	Pyrene	TRG	1700	18000	840	840	0.100	ND
Total Metals (mg/kg)							PQL	Result
7429-90-5	Aluminum	TRG	78000	NA	6000	6000	5.00	3820
7440-36-0	Antimony	TRG	31	450	6	6	0.50	ND
7440-38-2	Arsenic	TRG	19	19	19	19	0.50	4.98
7440-39-3	Barium	TRG	16000	59000	2100	2100	0.50	24.2
7440-41-7	Beryllium	TRG	16	140	0.7	0.7	0.50	ND
7440-43-9	Cadmium	TRG	78	78	2	2	0.50	ND
7440-47-3	Chromium	TRG	120000	NA	s spec.	120000	0.50	12.5
16065-83-1	Chromium, Trivalent	TRG	NA	NA	NA	NA	1.25	12.5
7440-48-4	Cobalt	TRG	1600	590	90	90	0.50	1.15
7440-50-8	Copper	TRG	3100	45000	11000	3100	0.50	18.1
7439-92-1	Lead	TRG	400	800	90	90	0.50	9.53
7439-96-5	Manganese	TRG	11000	5900	65	65	0.50	58.0
7439-97-6	Mercury	TRG	23	65	0.1	0.1	0.17	ND
7440-02-0	Nickel	TRG	1600	23000	48	48	0.50	3.26
7782-49-2	Selenium	TRG	390	5700	11	11	0.50	ND
7440-22-4	Silver	TRG	390	5700	1	1	0.50	ND
7440-28-0	Thallium	TRG	5	79	3	3	0.50	ND
7440-62-2	Vanadium	TRG	78	1100	NA	78	0.50	13.2
7440-66-6	Zinc	TRG	23000	110000	930	930	0.50	32.2
Volatile Organics - GC/MS (mg/kg)							PQL	Result
71-55-6	1,1,1-Trichloroethane	TRG	290	4200	0.3	0.3	0.005	ND
79-34-5	1,1,2,2-Tetrachloroethane	TRG	1	3	0.007	0.007	0.005	ND
76-13-1	1,1,2-Trichloro-1,2,2 Trifluoroethane	TRG	NA	NA	NA	NA	0.100	ND
79-00-5	1,1,2-Trichloroethane	TRG	2	6	0.02	0.02	0.005	ND
75-34-3	1,1-Dichloroethane	TRG	8	24	0.2	0.2	0.005	ND
75-35-4	1,1-Dichloroethene	TRG	11	150	0.008	0.008	0.005	ND
87-61-6	1,2,3-Trichlorobenzene	TRG	NA	NA	NA	NA	0.005	ND
120-82-1	1,2,4-Trichlorobenzene	TRG	73	820	0.7	0.7	0.005	ND
96-12-8	1,2-Dibromo-3-chloropropane	TRG	0.08	0.2	0.005	0.005	0.005	ND
106-93-4	1,2-Dibromoethane	TRG	0.008	0.04	0.005	0.005	0.005	ND
95-50-1	1,2-Dichlorobenzene	TRG	5300	59000	17	17	0.005	ND
107-06-2	1,2-Dichloroethane	TRG	0.9	3	0.005	0.005	0.005	ND
78-87-5	1,2-Dichloropropane	TRG	2	5	0.005	0.005	0.005	ND
541-73-1	1,3-Dichlorobenzene	TRG	5300	59000	19	19	0.005	ND
106-46-7	1,4-Dichlorobenzene	TRG	5	13	2	2	0.005	ND

78-93-3	2-Butanone	TRG	3100	44000	0.9	0.9		0.050	ND
591-78-6	2-Hexanone	TRG	NA	NA	NA	NA		0.005	ND
108-10-1	4-Methyl-2-pentanone	TRG	NA	NA	NA	NA		0.005	ND
67-64-1	Acetone	TRG	70000	NA	19	19		0.050	ND
71-43-2	Benzene	TRG	2	5	0.005	0.005		0.005	ND
74-97-5	Bromochloromethane	TRG	NA	NA	NA	NA		0.005	ND
75-27-4	Bromodichloromethane	TRG	1	3	0.005	0.005		0.005	ND
75-25-2	Bromoform	TRG	81	280	0.03	0.03		0.005	ND
74-83-9	Bromomethane	TRG	25	59	0.04	0.04		0.005	ND
75-15-0	Carbon disulfide	TRG	7800	110000	6	6		0.005	ND
56-23-5	Carbon Tetrachloride	TRG	0.6	2	0.005	0.005		0.005	ND
108-90-7	Chlorobenzene	TRG	510	7400	0.6	0.6		0.005	ND
124-48-1	Chlorodibromomethane	TRG	3	8	0.005	0.005		0.005	ND
75-00-3	Chloroethane	TRG	220	1100	NA	220		0.005	ND
67-66-3	Chloroform	TRG	0.6	2	0.4	0.4		0.005	ND
74-87-3	Chloromethane	TRG	4	12	NA	4		0.005	ND
156-59-2	cis-1,2-Dichloroethene	TRG	230	560	0.3	0.3		0.005	ND
10061-01-5	cis-1,3-Dichloropropene	TRG	2	7	0.005	0.005		0.005	ND
110-82-7	Cyclohexane	TRG	NA	NA	NA	NA		0.005	ND
75-71-8	Dichlorodifluoromethane	TRG	490	230000	39	39		0.005	ND
100-41-4	EthylBenzene	TRG	7800	110000	13	13		0.005	ND
98-82-8	Isopropylbenzene	TRG	NA	NA	NA	NA		0.005	ND
79-20-9	Methyl Acetate	TRG	78000	NA	22	22		0.005	ND
1634-04-4	Methyl tert-Butyl Ether	TRG	110	320	0.2	0.2		0.005	ND
108-87-2	Methylcyclohexane	TRG	NA	NA	NA	NA		0.005	ND
75-09-2	Methylene Chloride	TRG	34	97	0.01	0.01		0.005	ND
100-42-5	Styrene	TRG	90	260	3	3		0.005	ND
75-65-0	tert-Butyl alcohol	TRG	1400	11000	0.3	0.3		0.050	ND
127-18-4	Tetrachloroethene	TRG	2	5	0.005	0.005		0.005	ND
108-88-3	Toluene	TRG	6300	91000	7	7		0.005	ND
TOT-XYL	Total Xylenes	TRG	12000	170000	19	19		0.015	ND
156-60-5	trans-1,2-Dichloroethene	TRG	300	720	0.6	0.6		0.005	ND
10061-02-6	trans-1,3-Dichloropropene	TRG	2	7	0.005	0.005		0.005	ND
79-01-6	Trichloroethene	TRG	7	20	0.01	0.01		0.005	ND
75-69-4	Trichlorofluoromethane	TRG	23000	340000	34	34		0.005	ND
75-01-4	Vinyl chloride	TRG	0.7	2	0.005	0.005		0.005	ND

Footnotes:

Residential and Non-residential standards are based upon the September 2, 2009 NJDEP publication.
Impact to Groundwater values based upon December 2008 NJDEP Guidance document
MAEL is not responsible for the accuracy, update or interpretation of the regulatory values

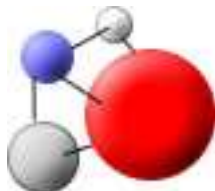

Mid-Atlantic

Environmental Laboratories, Inc.

30 Lukens Drive, Suite A
New Castle, DE 19720

Phone: 302-654-1340 / TOLL FREE: 877-654-1340

www.maelinc.com

mael@maelinc.com



Analytical Report

Project Name: SLF Topsoil

MAEL Job Number: 46141

Client: Beneficial Soil Solutions
12170 Mount Albert Road
Ellicott City MD 21042

Contact Name: Rick O'Brien

Date Received: 11/07/2016

Date Reported: 11/17/2016

Analytical test results for methods listed on the laboratory's scope of accreditation meet all requirements of NELAC unless otherwise noted. All sample holding times and preservation requirements were met unless otherwise noted. Test results relate only to the sample tested. This report shall not be reproduced, except in full, without prior written authorization of Mid-Atlantic Environmental Laboratories, Inc.

NYS 12047

M/DBE Certification
DE NJ PAUCP (SEPTA)
City of Philadelphia

NJ DE 003



PA 68-00566

DE Certification - C14DE02801B

MD Certification - 292

ANALYTICAL REPORT

Project Name: SLF Topsoil

Date Sampled: 11/7/2016 11:00 AM

Sampled By: HB

Sample Matrix: Soil

Sample Type: Composite

Lab Project #: 46141

Lab Sample #: 46141-1

Client Sample ID:

Analyte	CASRN	Result	Q	Units	Method	RL	Analyst	Date / Time Analysis
Chromium, Hexavalent - Non-aqueous								
Chromium, hexavalent	18540-29-9	ND		mg/kg	7196A	1.0	R B	11/10/2016 3:12 PM
Chromium, Trivalent - non-aqueous								
Chromium, Trivalent	16065-83-1	12.5		mg/kg	calc	1.25	W W	11/15/2016 9:21 AM
Cyanide, Total - non-aqueous								
Cyanide, Total	57-12-5	0.68		mg/kg	9010C/9014	0.20	R B	11/10/2016 1:58 PM
Mercury - Non-aqueous								
Mercury	7439-97-6	ND		mg/kg	7471A	0.17	K S	11/11/2016 12:47 PM
Metals (NJSCC-new 6010C) - non-aqueous								
Aluminum	7429-90-5	3820		mg/kg	6010B	5.00	K S	11/14/2016 10:21 AM
Antimony	7440-36-0	ND		mg/kg	6010B	0.50	K S	11/14/2016 10:21 AM
Arsenic	7440-38-2	4.98		mg/kg	6010B	0.50	K S	11/14/2016 10:21 AM
Barium	7440-39-3	24.2		mg/kg	6010B	0.50	K S	11/14/2016 10:21 AM
Beryllium	7440-41-7	ND		mg/kg	6010B	0.50	K S	11/14/2016 10:21 AM
Cadmium	7440-43-9	ND		mg/kg	6010B	0.50	K S	11/14/2016 10:21 AM
Chromium	7440-47-3	12.5		mg/kg	6010B	0.50	K S	11/14/2016 10:21 AM
Cobalt	7440-48-4	1.15		mg/kg	6010B	0.50	K S	11/14/2016 10:21 AM
Copper	7440-50-8	18.1		mg/kg	6010B	0.50	K S	11/14/2016 10:21 AM
Lead	7439-92-1	9.53		mg/kg	6010B	0.50	K S	11/14/2016 10:21 AM
Manganese	7439-96-5	58.0		mg/kg	6010B	0.50	K S	11/14/2016 10:21 AM
Nickel	7440-02-0	3.26		mg/kg	6010B	0.50	K S	11/14/2016 10:21 AM
Selenium	7782-49-2	ND		mg/kg	6010B	0.50	K S	11/14/2016 10:21 AM
Silver	7440-22-4	ND		mg/kg	6010B	0.50	K S	11/14/2016 10:21 AM
Thallium	7440-28-0	ND		mg/kg	6010B	0.50	K S	11/14/2016 10:21 AM
Vanadium	7440-62-2	13.2		mg/kg	6010B	0.50	K S	11/14/2016 10:21 AM
Zinc	7440-66-6	32.2		mg/kg	6010B	0.50	K S	11/14/2016 10:21 AM

PCBs - Non-aqueous

NYS 12047

ANALYTICAL REPORT

Project Name: SLF Topsoil

Date Sampled: 11/7/2016 11:00 AM

Lab Project #: 46141

Sampled By: HB

Lab Sample #: 46141-1

Sample Matrix: Soil

Client Sample ID:

Sample Type: Composite

Analyte	CASRN	Result	Q	Units	Method	RL	Analyst	Date / Time Analysis
PCBs - Non-aqueous								
PCB-1016	12674-11-2	ND		mg/kg	8082A	0.025	C Q	11/17/2016 12:45 PM
PCB-1221	11104-28-2	ND		mg/kg	8082A	0.025	C Q	11/17/2016 12:45 PM
PCB-1232	11141-16-5	ND		mg/kg	8082A	0.025	C Q	11/17/2016 12:45 PM
PCB-1242	53469-21-9	ND		mg/kg	8082A	0.025	C Q	11/17/2016 12:45 PM
PCB-1248	12672-29-6	ND		mg/kg	8082A	0.025	C Q	11/17/2016 12:45 PM
PCB-1254	11097-69-1	ND		mg/kg	8082A	0.025	C Q	11/17/2016 12:45 PM
PCB-1260	11096-82-5	ND		mg/kg	8082A	0.025	C Q	11/17/2016 12:45 PM
Percent Moisture/Percent Solid								
Total Moisture		27.7		%	2540B	0.10	josh walls	11/11/2016 3:39 PM
Pesticides (NJSCC-new) - non-aqueous								
Aldrin	309-00-2	ND		mg/kg	8081B	0.00125	C Q	11/17/2016 12:45 PM
alpha BHC	319-84-6	ND		mg/kg	8081B	0.00125	C Q	11/17/2016 12:45 PM
beta BHC	319-85-7	ND		mg/kg	8081B	0.00125	C Q	11/17/2016 12:45 PM
gamma BHC (Lindane)	58-89-9	ND		mg/kg	8081B	0.00125	C Q	11/17/2016 12:45 PM
alpha-Chlordane	5103-71-9	ND		mg/kg	8081B	0.00125	C Q	11/17/2016 12:45 PM
gamma-Chlordane	5103-74-2	ND		mg/kg	8081B	0.00125	C Q	11/17/2016 12:45 PM
4,4'-DDD	72-54-8	ND		mg/kg	8081B	0.00250	C Q	11/17/2016 12:45 PM
4,4'-DDE	72-55-9	ND		mg/kg	8081B	0.00250	C Q	11/17/2016 12:45 PM
4,4'-DDT	50-29-3	ND		mg/kg	8081B	0.00250	C Q	11/17/2016 12:45 PM
Dieldrin	60-57-1	ND		mg/kg	8081B	0.00250	C Q	11/17/2016 12:45 PM
Endosulfan I	959-98-8	ND		mg/kg	8081B	0.00125	C Q	11/17/2016 12:45 PM
Endosulfan II	33213-65-9	ND		mg/kg	8081B	0.00250	C Q	11/17/2016 12:45 PM
Endosulfan sulfate	1031-07-8	ND		mg/kg	8081B	0.00250	C Q	11/17/2016 12:45 PM
Endrin	72-20-8	ND		mg/kg	8081B	0.00250	C Q	11/17/2016 12:45 PM
Heptachlor	76-44-8	ND		mg/kg	8081B	0.00125	C Q	11/17/2016 12:45 PM
Heptachlor epoxide	1024-57-3	ND		mg/kg	8081B	0.00125	C Q	11/17/2016 12:45 PM
Methoxychlor	72-43-5	ND		mg/kg	8081B	0.01250	C Q	11/17/2016 12:45 PM
Toxaphene	8001-35-2	ND		mg/kg	8081B	0.02500	C Q	11/17/2016 12:45 PM
Semi Volatile Organics (NJSCC-new) - non-aqueous								
Acenaphthene	83-32-9	ND		mg/kg	8270D	0.100	R C	11/17/2016 2:05 PM

NYS 12047

M/DBE Certification
DE NJ PAUCP (SEPTA)
City of Philadelphia

NJ DE 003



PA 68-00566

DE Certification - C14DE02801B

MD Certification - 292

ANALYTICAL REPORT

Project Name: SLF Topsoil

Date Sampled: 11/7/2016 11:00 AM

Lab Project #: 46141

Sampled By: HB

Lab Sample #: 46141-1

Sample Matrix: Soil

Client Sample ID:

Sample Type: Composite

Analyte	CASRN	Result	Q	Units	Method	RL	Analyst	Date / Time Analysis
Semi Volatile Organics (NJSCC-new) - non-aqueous								
Benzo[a]anthracene	56-55-3	ND		mg/kg	8270D	0.100	R C	11/17/2016 2:05 PM
Benzo[b]fluoranthene	205-99-2	ND		mg/kg	8270D	0.100	R C	11/17/2016 2:05 PM
Benzo[k]fluoranthene	207-08-9	ND		mg/kg	8270D	0.100	R C	11/17/2016 2:05 PM
Benzo[a]pyrene	50-32-8	ND		mg/kg	8270D	0.100	R C	11/17/2016 2:05 PM
bis (2-Chloroethyl) ether	111-44-4	ND		mg/kg	8270D	0.100	R C	11/17/2016 2:05 PM
bis (2-chloroisopropyl) ether	108-60-1	ND		mg/kg	8270D	0.100	R C	11/17/2016 2:05 PM
bis (2-Ethylhexyl) phthalate	117-81-7	ND		mg/kg	8270D	0.100	R C	11/17/2016 2:05 PM
Butylbenzylphthalate	85-68-7	ND		mg/kg	8270D	0.100	R C	11/17/2016 2:05 PM
2-Chlorophenol	95-57-8	ND		mg/kg	8270D	0.100	R C	11/17/2016 2:05 PM
Chrysene	218-01-9	ND		mg/kg	8270D	0.100	R C	11/17/2016 2:05 PM
Dibenz[a,h]anthracene	53-70-3	ND		mg/kg	8270D	0.100	R C	11/17/2016 2:05 PM
Di-n-butylphthalate	84-74-2	ND		mg/kg	8270D	0.100	R C	11/17/2016 2:05 PM
1,4-Dichlorobenzene	106-46-7	ND		mg/kg	8270D	0.100	R C	11/17/2016 2:05 PM
3,3'-Dichlorobenzidine	91-94-1	ND		mg/kg	8270D	0.200	R C	11/17/2016 2:05 PM
2,4-Dichlorophenol	120-83-2	ND		mg/kg	8270D	0.100	R C	11/17/2016 2:05 PM
Diethylphthalate	84-66-2	ND		mg/kg	8270D	0.100	R C	11/17/2016 2:05 PM
2,4-Dimethylphenol	105-67-9	ND		mg/kg	8270D	0.100	R C	11/17/2016 2:05 PM
2,4-Dinitrophenol	51-28-5	ND		mg/kg	8270D	0.250	R C	11/17/2016 2:05 PM
Di-n-octylphthalate	117-84-0	ND		mg/kg	8270D	0.100	R C	11/17/2016 2:05 PM
Fluoranthene	206-44-0	ND		mg/kg	8270D	0.100	R C	11/17/2016 2:05 PM
Fluorene	86-73-7	ND		mg/kg	8270D	0.100	R C	11/17/2016 2:05 PM
Hexachlorobenzene	118-74-1	ND		mg/kg	8270D	0.100	R C	11/17/2016 2:05 PM
Hexachlorocyclopentadiene	77-47-4	ND		mg/kg	8270D	0.250	R C	11/17/2016 2:05 PM
Indeno[1,2,3-cd]pyrene	193-39-5	ND		mg/kg	8270D	0.100	R C	11/17/2016 2:05 PM
Isophorone	78-59-1	ND		mg/kg	8270D	0.100	R C	11/17/2016 2:05 PM
n-Nitroso-di-n-propylamine	621-64-7	ND		mg/kg	8270D	0.100	R C	11/17/2016 2:05 PM
Pentachlorophenol	87-86-5	ND		mg/kg	8270D	0.100	R C	11/17/2016 2:05 PM
Phenol	108-95-2	ND		mg/kg	8270D	0.100	R C	11/17/2016 2:05 PM
Pyrene	129-00-0	ND		mg/kg	8270D	0.100	R C	11/17/2016 2:05 PM
2,4,5-Trichlorophenol	95-95-4	ND		mg/kg	8270D	0.100	R C	11/17/2016 2:05 PM
2,4,6-Trichlorophenol	88-06-2	ND		mg/kg	8270D	0.100	R C	11/17/2016 2:05 PM
n-Nitrosodiphenylamine	86-30-6	ND		mg/kg	8270D	0.100	R C	11/17/2016 2:05 PM

NYS 12047



ANALYTICAL REPORT

Project Name: SLF Topsoil

Date Sampled: 11/7/2016 11:00 AM

Lab Project #: 46141

Sampled By: HB

Lab Sample #: 46141-1

Sample Matrix: Soil

Client Sample ID:

Sample Type: Composite

Analyte	CASRN	Result	Q	Units	Method	RL	Analyst	Date / Time Analysis
Semi Volatile Organics (NJSCC-new) - non-aqueous								
Anthracene	120-12-7	ND		mg/kg	8270D	0.100	R C	11/17/2016 2:05 PM
Acenaphthylene	208-96-8	ND		mg/kg	8270D	0.100	R C	11/17/2016 2:05 PM
Acetophenone	98-86-2	ND		mg/kg	8270D	0.100	R C	11/17/2016 2:05 PM
Atrazine	1912-24-9	ND		mg/kg	8270D	0.100	R C	11/17/2016 2:05 PM
Benzaldehyde	100-52-7	ND		mg/kg	8270D	0.100	R C	11/17/2016 2:05 PM
Benzidine	92-87-5	ND		mg/kg	8270D	0.200	R C	11/17/2016 2:05 PM
Benzo[g,h,i]perylene	191-24-2	ND		mg/kg	8270D	0.100	R C	11/17/2016 2:05 PM
1,1-Biphenyl	92-52-4	ND		mg/kg	8270D	0.100	R C	11/17/2016 2:05 PM
Caprolactam	105-60-2	ND		mg/kg	8270D	0.100	R C	11/17/2016 2:05 PM
Carbazole	86-74-8	ND		mg/kg	8270D	0.100	R C	11/17/2016 2:05 PM
2,4-Dinitrotoluene	121-14-2	ND		mg/kg	8270D	0.100	R C	11/17/2016 2:05 PM
2,6-Dinitrotoluene	606-20-2	ND		mg/kg	8270D	0.100	R C	11/17/2016 2:05 PM
4,6-Dinitro-2-methylphenol	534-52-1	ND		mg/kg	8270D	0.100	R C	11/17/2016 2:05 PM
1,2-Diphenylhydrazine	122-66-7	ND		mg/kg	8270D	0.100	R C	11/17/2016 2:05 PM
2-Methylnaphthalene	91-57-6	ND		mg/kg	8270D	0.100	R C	11/17/2016 2:05 PM
2-Nitroaniline	88-74-4	ND		mg/kg	8270D	0.100	R C	11/17/2016 2:05 PM
N-nitrosodimethylamine	62-75-9	ND		mg/kg	8270D	0.100	R C	11/17/2016 2:05 PM
Phenanthrene	85-01-8	ND		mg/kg	8270D	0.100	R C	11/17/2016 2:05 PM
o-Cresol (2-Methylphenol)	95-48-7	ND		mg/kg	8270D	0.100	R C	11/17/2016 2:05 PM
Benzyl Alcohol	100-51-6	ND		mg/kg	8270D	0.100	R C	11/17/2016 2:05 PM
4-Chloroaniline	106-47-8	ND		mg/kg	8270D	0.100	R C	11/17/2016 2:05 PM
4-Chloro-3-methylphenol	59-50-7	ND		mg/kg	8270D	0.100	R C	11/17/2016 2:05 PM
Naphthalene	91-20-3	ND		mg/kg	8270D	0.100	R C	11/17/2016 2:05 PM
2-Nitrophenol	88-75-5	ND		mg/kg	8270D	0.100	R C	11/17/2016 2:05 PM
3- & 4- Methylphenol	61379-65-5	ND		mg/kg	8270D	0.100	R C	11/17/2016 2:05 PM
bis (2-Chloroethoxy) methane	111-91-1	ND		mg/kg	8270D	0.100	R C	11/17/2016 2:05 PM
Volatile Organics (NJSCC-new) - non-aqueous								
1,1,2-Trichloro-1,2, 2-Trifluoroethane UnCorr		ND		mg/kg	8260C	0.100	R P	11/13/2016 11:02 AM
1,2,3-Trichlorobenzene UnCorr		ND		mg/kg	8260C	0.005	R P	11/13/2016 11:02 AM
Bromochloromethane UnCorr		ND		mg/kg	8260C	0.005	R P	11/13/2016 11:02 AM

NYS 12047



ANALYTICAL REPORT

Project Name: SLF Topsoil

Date Sampled: 11/7/2016 11:00 AM

Sampled By: HB

Sample Matrix: Soil

Sample Type: Composite

Lab Project #: 46141

Lab Sample #: 46141-1

Client Sample ID:

Analyte	CASRN	Result	Q	Units	Method	RL	Analyst	Date / Time Analysis
Volatile Organics (NJSCC-new) - non-aqueous								
Cyclohexane Uncorr		ND		mg/kg	8260C	0.005	R P	11/13/2016 11:02 AM
Isopropylbenzene (Cumene) UnCorr		ND		mg/kg	8260C	0.005	R P	11/13/2016 11:02 AM
Methylcyclohexane Uncorr		ND			8260C	0.005	R P	11/13/2016 11:02 AM
Acetone	67-64-1	ND		mg/kg	8260C	0.05	R P	11/13/2016 11:02 AM
Acrylonitrile	107-13-1	ND		mg/kg	8260C	0.005	R P	11/13/2016 11:02 AM
Benzene	71-43-2	ND		mg/kg	8260C	0.005	R P	11/13/2016 11:02 AM
Bromodichloromethane	75-27-4	ND		mg/kg	8260C	0.005	R P	11/13/2016 11:02 AM
Bromoform (Tribromomethane)	75-25-2	ND		mg/kg	8260C	0.005	R P	11/13/2016 11:02 AM
Bromomethane	74-83-9	ND		mg/kg	8260C	0.005	R P	11/13/2016 11:02 AM
Carbon Tetrachloride	56-23-5	ND		mg/kg	8260C	0.005	R P	11/13/2016 11:02 AM
Chlorobenzene	108-90-7	ND		mg/kg	8260C	0.005	R P	11/13/2016 11:02 AM
Chloroform	67-66-3	ND		mg/kg	8260C	0.005	R P	11/13/2016 11:02 AM
Chloromethane (Methyl Chloride)	74-87-3	ND		mg/kg	8260C	0.005	R P	11/13/2016 11:02 AM
Dibromochloromethane	124-48-1	ND		mg/kg	8260C	0.005	R P	11/13/2016 11:02 AM
1,1-Dichloroethane	75-34-3	ND		mg/kg	8260C	0.005	R P	11/13/2016 11:02 AM
cis-1,2-Dichloroethene	156-59-2	ND		mg/kg	8260C	0.005	R P	11/13/2016 11:02 AM
trans-1,2-Dichloroethene	156-60-5	ND		mg/kg	8260C	0.005	R P	11/13/2016 11:02 AM
Ethylbenzene	100-41-4	ND		mg/kg	8260C	0.005	R P	11/13/2016 11:02 AM
Hexachlorobutadiene	87-68-3	ND		mg/kg	8260C	0.005	R P	11/13/2016 11:02 AM
Hexachloroethane	67-72-1	ND		mg/kg	8260C	0.005	R P	11/13/2016 11:02 AM
Methyl Ethyl Ketone (MEK)	78-93-3	ND		mg/kg	8260C	0.050	R P	11/13/2016 11:02 AM
Methylene Chloride (Dichloromethane)	75-09-2	ND		mg/kg	8260C	0.005	R P	11/13/2016 11:02 AM
Naphthalene	91-20-3	ND		mg/kg	8260C	0.020	R P	11/13/2016 11:02 AM
Nitrobenzene	98-95-3	ND		mg/kg	8260C	0.050	R P	11/13/2016 11:02 AM
Styrene	100-42-5	ND		mg/kg	8260C	0.005	R P	11/13/2016 11:02 AM
1,1,2,2-Tetrachloroethane	79-34-5	ND		mg/kg	8260C	0.005	R P	11/13/2016 11:02 AM
Tetrachloroethene (PCE)	127-18-4	ND		mg/kg	8260C	0.005	R P	11/13/2016 11:02 AM
Toluene	108-88-3	ND		mg/kg	8260C	0.005	R P	11/13/2016 11:02 AM
1,2,4-Trichlorobenzene	120-82-1	ND		mg/kg	8260C	0.005	R P	11/13/2016 11:02 AM

NYS 12047

ANALYTICAL REPORT

Project Name: SLF Topsoil

Date Sampled: 11/7/2016 11:00 AM

Sampled By: HB

Sample Matrix: Soil

Sample Type: Composite

Lab Project #: 46141

Lab Sample #: 46141-1

Client Sample ID:

Analyte	CASRN	Result	Q	Units	Method	RL	Analyst	Date / Time Analysis
Volatile Organics (NJSCC-new) - non-aqueous								
Trichloroethene (TCE)	79-01-6	ND		mg/kg	8260C	0.005	R P	11/13/2016 11:02 AM
Vinyl Chloride	75-01-4	ND		mg/kg	8260C	0.005	R P	11/13/2016 11:02 AM
Xylenes, Total	1330-20-7	ND		mg/kg	8260C	0.015	R P	11/13/2016 11:02 AM
1,1-Dichloroethene	75-35-4	ND		mg/kg	8260C	0.005	R P	11/13/2016 11:02 AM
cis-1,3-Dichloropropene	10061-01-5	ND		mg/kg	8260C	0.005	R P	11/13/2016 11:02 AM
trans-1,3-Dichloropropene	10061-02-6	ND		mg/kg	8260C	0.005	R P	11/13/2016 11:02 AM
1,2-Dichloropropane	78-87-5	ND		mg/kg	8260C	0.005	R P	11/13/2016 11:02 AM
1,1,1-Trichloroethane	71-55-6	ND		mg/kg	8260C	0.005	R P	11/13/2016 11:02 AM
1,1,2-Trichloroethane	79-00-5	ND		mg/kg	8260C	0.005	R P	11/13/2016 11:02 AM
Acrolein	107-02-8	ND		mg/kg	8260C	0.050	R P	11/13/2016 11:02 AM
Carbon disulfide	75-15-0	ND		mg/kg	8260C	0.005	R P	11/13/2016 11:02 AM
Chloroethane	75-00-3	ND		mg/kg	8260C	0.005	R P	11/13/2016 11:02 AM
1,2-Dibromo-3-chloropropane (DBCP)	96-12-8	ND		mg/kg	8260C	0.005	R P	11/13/2016 11:02 AM
1,2-Dibromoethane (EDB)	106-93-4	ND		mg/kg	8260C	0.005	R P	11/13/2016 11:02 AM
Dichlorodifluoromethane	75-71-8	ND		mg/kg	8260C	0.005	R P	11/13/2016 11:02 AM
Methyl tert-butyl ether (MTBE)	1634-04-4	ND		mg/kg	8260C	0.005	R P	11/13/2016 11:02 AM
Methyl Acetate	79-20-9	ND		mg/kg	8260C	0.005	R P	11/13/2016 11:02 AM
tert-Butyl alcohol (TBA)	75-65-0	ND		mg/kg	8260C	0.050	R P	11/13/2016 11:02 AM
Trichlorofluoromethane	75-69-4	ND		mg/kg	8260C	0.005	R P	11/13/2016 11:02 AM
1,2-Dichloroethane	107-06-2	ND		mg/kg	8260C	0.005	R P	11/13/2016 11:02 AM
1,2-Dichlorobenzene	95-50-1	ND		mg/kg	8260C	0.005	R P	11/13/2016 11:02 AM
1,3-Dichlorobenzene	541-73-1	ND		mg/kg	8260C	0.005	R P	11/13/2016 11:02 AM
1,4-Dichlorobenzene	106-46-7	ND		mg/kg	8260C	0.005	R P	11/13/2016 11:02 AM
1,1,2-Trichloro-1,2,2-Trifluoroethane	76-13-1	ND		mg/kg	8260C	0.100	R P	11/13/2016 11:02 AM
1,2,3-Trichlorobenzene	87-61-6	ND		mg/kg	8260C	0.005	R P	11/13/2016 11:02 AM
Bromochloromethane	74-97-5	ND		mg/kg	8260C	0.005	R P	11/13/2016 11:02 AM
Cyclohexane	110-82-7	ND		mg/kg	8260C	0.005	R P	11/13/2016 11:02 AM
Isopropylbenzene (Cumene)	98-82-8	ND		mg/kg	8260C	0.005	R P	11/13/2016 11:02 AM
Methylcyclohexane	108-87-2	ND		mg/kg	8260C	0.005	R P	11/13/2016 11:02 AM

NYS 12047

M/DBE Certification
DE NJ PAUCP (SEPTA)
City of Philadelphia

NJ DE 003



PA 68-00566

DE Certification - C14DE02801B

MD Certification - 292

ANALYTICAL REPORT

Project Name: SLF Topsoil

Date Sampled: 11/7/2016 11:00 AM

Sampled By: HB

Sample Matrix: Soil

Sample Type: Composite

Lab Project #: 46141

Lab Sample #: 46141-1

Client Sample ID:



Akhter Mehmood
Lab Director

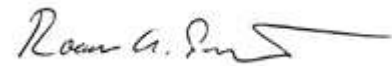

Rocus Peters
QAQC Director

NYS 12047

M/DBE Certification
DE NJ PAUCP (SEPTA)
City of Philadelphia

NJ DE 003



PA 68-00566

DE Certification - C14DE02801B

MD Certification - 292

ANALYTICAL REPORT

Methodology

All analyses are adapted from one or more of the following reference methods:

- “Guidelines Establishing Test Procedures for the Analysis of Pollutants” Code of Federal Regulations, Vol. 40, Part 136
- “Test Methods for Evaluating Solid Waste”, SW846 Third Edition, September 1986, USEPA.
- Code of Federal Regulations Vol. 40, Part 261, “Appendix II Method 1311 Toxicity Characteristic Leaching Procedure.”
- Standard Methods for the Examination of Water and Wastewater”, 18th & 21st editions
- “Methods for the Chemical Analysis of Water and Wastes”, EPA600/4-79-020, March 1983, U.S. EPA, EMSL
- “Annual Book of Standards, Section 11-Water”, American Society for Testing and Materials (ASTM)
- “Methods for the Determination of Organic Compounds in Drinking Water”, EPA 600/4-88/039, December 1988

Qualifiers

B	Detected in method blank	E	Detected above calibration limits, result estimated
H	Parameter run out of hold time	J	Detected below PQL, result estimated
P	Incorrect Preservative	R	See report notes
SUB	Sub-Contracted to Certified Lab	N	Not NELAP/TNI certified for parameter

Abbreviations

ppm	Parts Per Million (mg/kg or mg/L)	PQL	Practical Quantitation Level
ppb	Parts Per Billion (ug/kg or ug/L)	attached	Subcontract Lab Report Attached
g	gram (1000 g = 1Kg)	ND	Not Detected
kg	kilogram (1 kg = 1000 g)	NA	Not Applicable
mg	milligram (1000 mg = 1 g)	NS	Not Spiked
mg/kg	milligram per kilogram (ppm)	NP	No PCB pattern detected
ug/kg	microgram per kilogram (ppb)	NR	Not Requested
ug	microgram (1000 ug = 1 mg)	NI	Not Ignitable
L	liter (1 L = 1000 mL)	NFL	No Free Liquid
ml	milliliter (1000 ml = 1 L)	NTU	Nephelometric Turbidity Units
ul	microliter (1000 ul = 1 ml)	S.U.	Standard Unit
mg/L	milligram per liter (ppm)	RPD	Relative Percent Difference
ug/L	microgram per liter (ppb)	RSD	Relative Standard Deviation
ng/kg	nanogram per kilogram	MS/MSD	Matrix Spike/Matrix Spike Duplicate
BTU/lb	British Thermal Units per pound	LCS	Laboratory Control Sample
CFU/mL	Colony Forming Units per milliliter	BS	Blank Spike (Method Spike)
MPN/100 ml	Most Probable Number per 100 mL	o F	degrees Fahrenheit
mS/cm	milli Siemens per centimeter	o C	degrees Celsius
uS/cm	micro Siemens per centimeter	umhos	Conductivity Units
ug/sq cm	microgram per square centimeter	ohms	Resistivity Units
ug/sq ft	microgram per square feet	RL	Reporting Limit
ug/wipe	microgram per wipe		

Note: All non-aqueous samples, with the exception of oils, wipes, and paint chips are dry weight corrected
PQL-The Practical Quantitation Limit (PQL) is the lowest level that can be reliably achieved within specified limits of precision and accuracy during routine laboratory operating conditions.
RL-Reporting Limit is greater than or equal to PQL.

NYS 12047

M/DBE Certification
DE NJ PAUCP (SEPTA)
City of Philadelphia

NJ DE 003



PA 68-00566

DE Certification - C14DE02801B

MD Certification - 292



Mid-Atlantic
Environmental Laboratories, Inc.
 30 Lakens Drive, Suite A
 New Castle, DE 19720
 Phone: 302-654-1340 TOLL FREE 877-854-1340 Fax 302-654-1050
 www.midatlanticlabs.com
 mail@midatlanticlabs.com

CHAIN OF CUSTODY

Lab Use Only

Job # 46141

Client Name: Beneficial Soil Solution		Invoice To: BSSI		Sample On Ice <input type="checkbox"/> Yes <input type="checkbox"/> No		Data Format Requested		Report Format	
Address: 12170 Mount Albert Road		Purchase Order #:		Sample Disposal <input type="checkbox"/> Client <input type="checkbox"/> MAEL		<input type="checkbox"/> Results Only		<input type="checkbox"/> Fax	
City, State, Zip: Ellicott City, MD 21042		Project Name: <u>SLF Topsoil</u>		Site Location <input type="checkbox"/> NJ <input type="checkbox"/> PA <input type="checkbox"/> DE <input type="checkbox"/> MD <input type="checkbox"/> Other		<input type="checkbox"/> QC Package		X <input type="checkbox"/> E-mail PDF	
Contact Name: Rick OBrien		Bottle Order #		Quote #		<input type="checkbox"/> NJRDD + Hazsite		<input type="checkbox"/> Portal Posting Only	
Phone # 410.531.3205		Regulatory Program		Turn Around Time		<input type="checkbox"/> NJFDD + Hazsite			
Fax # 410.531.3205		<input type="checkbox"/> DERBCAP <input type="checkbox"/> PA UST		<input type="checkbox"/> <24 Hours (Same Day)		<input type="checkbox"/> MDE			
E-mail: rick@beneficialsoilsolution.com		<input type="checkbox"/> PA Clean Fill <input type="checkbox"/> PA ACT II		<input type="checkbox"/> 24 Hours (Next Day)					
Remarks: Excel Summary Compared to NJ Res, Non Res, IGW		<input type="checkbox"/> NJGWQC <input checked="" type="checkbox"/> NJ SRP		<input type="checkbox"/> 48 Hours (2 Days)					
		<input type="checkbox"/> NJ UST <input type="checkbox"/> MDE		<input type="checkbox"/> 72 Hours (3 Days)					
		<input type="checkbox"/> Site Specific <input type="checkbox"/> Non regulatory		<input type="checkbox"/> 96 Hours (4 Days)					
		<input type="checkbox"/> Other (Specify):		<input checked="" type="checkbox"/> Standard (1 Week)					
		Failure to include regulatory program may result in PQLs incompatible to regulatory limit. If not specified, assumed to be non-regulatory.		<input type="checkbox"/> 2 Weeks					
				<input type="checkbox"/> Other - Specify					

Handwritten notes:
 AVE-SRS
 FERTILIZER
 NJSRP

Laboratory Sample #	Client Sample ID	Sampling Info		AM PM	Sampled By:	Sample Type		Matrix	# Cntrs	Analysis Requested															
		Date	Time			Grab	Comp																		
	46141-1	11/7/16	11:00	A	MB		X	Soil	1																

Bottles Supplied By MAEL? Yes No	Logged By: <u>Wayne Hill</u> 11/7/16	QA Reviewed:	Page of
Relinquished By: <u>[Signature]</u>	Date: 11/7/16	Time: 11:54A	Received By: <u>[Signature]</u>
Date: 11/7/16	Time: 11:54A	Date: 11/7/16	Time: 11:54A
Relinquished By:	Date:	Time:	Received By:
Date:	Time:	Date:	Time:

All samples are disposed 30 days after receipt unless otherwise requested. By signing this Chain of Custody Agreement, customer expressly agrees to pay Mid-Atlantic Environmental Laboratories, Inc. for all charges reasonably incurred in connection with analysis and reporting of these samples. Please provide additional aqueous sample whenever possible in order to ensure there is sufficient sample for method QA/QC, as well as for any re-analysis that may be required.



CERTIFIED TESTING LABORATORIES, INC.

CLIENT: Beneficial Soil Solution
12170 Mt. Albert Road
Ellicott City, MD 21042

DATE: 12-24-2016

LAB NO: B-214-16

PROJECT:

REPORT NO.: AG-34

ON SAMPLE OF: Topsoil Material

SAMPLED BY: Client

RECEIVED: 12-21-2016

MARKED: Sample#1 - TS-1

EXAMINED WITH THE FOLLOWING RESULTS:

1. Grain size analysis (ASTM D 422). Material finer than the #200 (ASTM D 1140).

<u>Sieve Size</u>	<u>% Passing</u>
2"	100.0
1"	100.0
3/4"	100.0
3/8"	100.0
#4	97.9
#10	94.9
#40	74.6
#60	50.3
#100	36.4
#200	28.5
#270	26.3

2. pH Value (ASTM D 4972): 8.3

3. % Organics (ASTM D 2974): 13.5%

Respectfully Submitted,
Certified Testing Laboratories, Inc.

Terry Kifer, General Manager

TK/mir

All reports are the confidential property of clients and information contained may not be published or reproduced, pending our written approval

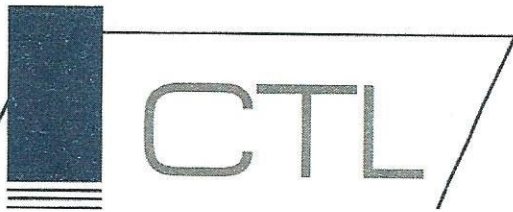

CERTIFIED TESTING LABORATORIES, INC.

CLIENT: Beneficial Soil Solution
12170 Mt. Albert Road
Ellicott City, MD 21042

DATE: 12-24-2016

LAB NO: B-214-16

PROJECT:

REPORT NO.: AG-35

ON SAMPLE OF: Topsoil Material

SAMPLED BY: Client

RECEIVED: 12-21-2016

MARKED: Sample#2 - TS-2

EXAMINED WITH THE FOLLOWING RESULTS:

1. Grain size analysis (ASTM D 422). Material finer than the #200 (ASTM D 1140).

<u>Sieve Size</u>	<u>% Passing</u>
2"	100.0
1"	100.0
3/4"	100.0
3/8"	95.5
#4	93.7
#10	91.4
#40	72.8
#60	50.0
#100	37.4
#200	29.1
#270	26.8

2. pH Value (ASTM D 4972): 8.4

3. % Organics (ASTM D 2974): 11.1%

Respectfully Submitted,
Certified Testing Laboratories, Inc.

Terry Kifer, General Manager

TK/mir

All reports are the confidential property of clients and information contained may not be published or reproduced, pending our written approval

155 U.S. Route 130, Bordentown, New Jersey 08505 Phone: (609) 298-3255 Fax: (609) 298-7288

Soil Test Report

Lab #: 2017- 58198

ATC Group Services LLC
Scott McLaughlin
3 Terri Lane
Suite 4
Burlington, NJ 08016

Date Received: 2017-03-21
Date Reported: 2017-03-27

scott.mclaughlin@atcassociates.com
(609)479-8526
(609)386-7951(fax)
Sample ID: ABC Barrel TS1

Crop or Plant
NewTurfgrass, cool season

Results and Interpretations

Sandy Loam

pH: 7.24 Slightly alkaline; above optimum pH for most plants.

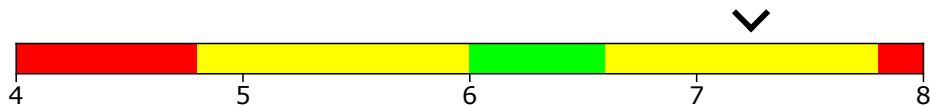

Macronutrients (pounds per acre)

by Mehlich 3 extraction

Phosphorus: 1005 (Above Optimum)
Potassium: 4329 (Above Optimum)
Magnesium: 1387 (Above Optimum)
Calcium: 6565 (Above Optimum)

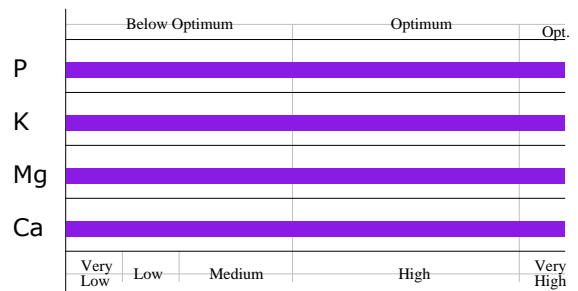

Micronutrients (parts per million)

Zinc(Zn) 24.84 (Adequate)	Copper(Cu) 6.35 (Adequate)	Manganese(Mn) 34.22 (High)	Boron(B) 4.48 (Adequate)	Iron(Fe) 383.50 (High)
-------------------------------------	--------------------------------------	--------------------------------------	------------------------------------	----------------------------------

Special Tests Results

Soluble Salts- Electrical conductivity= 3.58 mmho/cm
(Very High ; will 'burn' plant roots, causing drought-like symptoms)

Organic Matter by Carbon Analysis: Organic Matter=7.8%

Very High for Sandy Loam

Gravel Content- Larger than 2mm: 9.1%

Mechanical Analysis- Sand= 70% Silt=16% Clay= 14% Texture: Sandy Loam

Measured Cation Exchange Capacity: 12.93 meq/100g

pH, Calcium, and Magnesium Recommendations

The soil pH is higher than the optimum range of 6.00 to 6.60 for the growth of most Turfgrass, cool season. Do not apply any limestone, compost or wood ashes to the area.

Prior to new seeding/planting, soil pH should be adjusted by application and thorough mixing of powdered elemental sulfur into the root zone (8-10 inches deep). Apply the elemental sulfur at a rate of 8 pounds per 1000 square feet.

Till or otherwise mix to distribute the sulfur as uniformly as possible. Follow amendment by watering and keep soil moist over the subsequent several weeks to promote the acidification process.

Fertilizer Recommendations

Report

LATE SUMMER OR EARLY FALL is the best time to establish cool-season grasses. EARLY SPRING establishment can also be successful but is riskier and may require more input of effort and resources. N.J. law prohibits application of fertilizer containing nitrogen or phosphorus after November 15 (December 1 for professional certified applicators) and before March 1.

Target ratio for fertilizer product is: 1-1-1, which represents the fertilizer's relative amounts of nitrogen (N), phosphorus as P_2O_5 , and potassium as K_2O .

The estimated yearly nitrogen (N) need of this new seeding/sodding is 1 pound per 1000 square feet. New plantings allow mixing of the fertilizer into the soil to build up root zone fertility before planting.

DO THIS: Uniformly apply fertilizer(s) with N:P:K ratio indicated above to achieve 0.9 pound Nitrogen per 1000 square feet, and mix into soil depth of 4 inches.

TWO to FOUR WEEKS AFTER EMERGENCE of seedlings or placing sod, additional fertilizer is recommended to promote rapid establishment. If seeding/sodding in spring, this application should be repeated in September and October, at least 5 weeks apart; or for sandy soils, split applications into half-rate and apply four times, 3 weeks apart.

Rutgers Cooperative Extension encourages use of fertilizers having a water-insoluble nitrogen (WIN) component as specified on the label. WIN serves as a slow, extended release source of nitrogen. A gentle rain or light watering after application will help rinse fertilizer into the root zone, but do not apply fertilizer just prior to expected heavy rainfall to avoid loss of fertilizer and pollution of stormwater.

DO THIS: Using a 2:1:1 fertilizer, apply 0.75 pound Nitrogen per 1000 square feet spread uniformly over the turf.

WHAT ABOUT NEXT YEAR? In the 2nd year of establishment, two periods of fertilization are suggested: 1) April, and 2) September. Avoid applying fertilizer during very hot, very dry weather. For sandy soils, it is also suggested that each application be split into two doses spaced 3 to 5 weeks apart to minimize potential for leaching loss.

The fertilizer prescription above is intended to bring soil nutrients to optimal or near-optimal conditions, and subsequent management recommendations are intended to maintain soil nutrients levels near optimum. A gentle rain or light watering after application will help rinse fertilizer into the root zone, but do not apply fertilizer prior to expected heavy

rainfall to avoid loss of fertilizer and pollution of stormwater.

The best nutrient ratio for maintenance fertilization of the turf beyond 2 years is best determined by another soil test.

DO THIS: return grass clippings to the Turfgrass when mowing to recycle nutrients. Use fertilizer with N:P:K ratio of: 1:0:0 (nitrogen only) or 4:0:1 or 2:0:1 or 1:0:1 (representing increasing amounts of potassium; doses of potassium may be necessary for sandy, low organic matter soils) to achieve 0.75 pound Nitrogen per 1000 square feet.

How do I find the proper fertilizer product?

For help finding appropriate fertilizers and rates, consult the Rutgers Soil Testing Laboratory website: rci.rutgers.edu/~soilslab/FertProducts/. The website lists commercially available products according to their nutrient analyses to assist you with product selection and calculation of amount required.

Select a fertilizer that has a nutrient grade (also known as guaranteed minimum analysis) the same as or a multiple of the values recommended, or select a close match to that ratio. When no single fertilizer product matches or approximates the recommended N:P₂O₅:K₂O nutrient ratio, it will be necessary to use two or more fertilizers to reach the correct balance of nutrients. The proper amount of fertilizer to apply in a single application depends on the actual fertilizer grade of the fertilizer product selected, the total area (square feet) to be treated, and the total number of fertilizer applications to be made throughout the year.

Micronutrient Statements

Zinc does not appear to be a limiting factor. For information about zinc in soil for plant nutrition, see FS721.

Copper does not appear to be a limiting factor. As with most other micronutrients, copper availability is related to soil pH. Do not over-lime. For more information about soil copper, see FS720.

Manganese may be toxic to sensitive crops when grown on low pH soil. Adding lime to the soil raises the pH and decreases manganese toxicity. Liming is generally not recommended for acid-loving plants, which are more tolerant of high levels of manganese. In excessive amounts, soil manganese can cause plant damage. This occurs primarily in low pH soil. Lime soil as recommended to decrease availability of manganese to plants. Avoid fertilizers that contain manganese. See FS973 for more information.

Boron would not be a limiting factor for most plants. Plant types differ in their requirement for boron, however; certain fruit, vegetables, and field crops have greater need for boron (up to 0.75 ppm). For more information, see FS873.

Plant availability to iron is highly dependent on soil pH. Although soil iron appears plentiful, high soil pH could limit its availability. On the other hand, plant damage due to iron toxicity, though not common, could occur at low soil pH (acidic soil). Maintain soil pH in the optimum range as described in Recommendations. See FS971 for more information.

Comments:

Find Rutgers Cooperative Extension Fact Sheets at www.njaes.rutgers.edu/pubs



Soil Test Report Lab #: 2017-58199

ATC Group Services LLC
Scott McLaughlin
3 Terri Lane
Suite 4
Burlington, NJ 08016

Date Received: 2017-03-21

Date Reported: 2017-03-27

scott.mclaughlin@atcassociates.com
(609)479-8526
(609)386-7951(fax)

Crop or Plant

NewTurfgrass, cool season

Sample ID: ABC Barrel TS2

Results and Interpretations

Sandy Loam

pH: 7.24 Slightly alkaline; above optimum pH for most plants.



Macronutrients (pounds per acre)

by Mehlich 3 extraction

Phosphorus: 1017 (Above Optimum)
Potassium: 4980 (Above Optimum)
Magnesium: 1431 (Above Optimum)
Calcium: 7745 (Above Optimum)

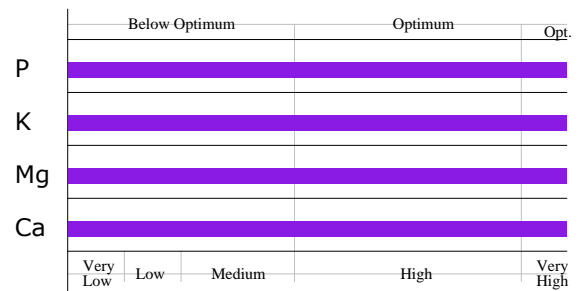

Micronutrients (parts per million)

Zinc(Zn) 28.29 (Adequate)	Copper(Cu) 7.09 (Adequate)	Manganese(Mn) 37.79 (High)	Boron(B) 4.92 (Adequate)	Iron(Fe) 382.70 (High)
-------------------------------------	--------------------------------------	--------------------------------------	------------------------------------	----------------------------------

Special Tests Results

Soluble Salts- Electrical conductivity= 3.92 mmho/cm
(Very High ; will 'burn' plant roots, causing drought-like symptoms)

Organic Matter by Carbon Analysis: Organic Matter=8.9%

Very High for Sandy Loam

Gravel Content- Larger than 2mm: 5.9%

Mechanical Analysis- Sand= 70% Silt=16% Clay= 14% Texture: Sandy Loam

Measured Cation Exchange Capacity: 13.01 meq/100g

pH, Calcium, and Magnesium Recommendations

The soil pH is higher than the optimum range of 6.00 to 6.60 for the growth of most Turfgrass, cool season. Do not apply any limestone, compost or wood ashes to the area.

Prior to new seeding/planting, soil pH should be adjusted by application and thorough mixing of powdered elemental sulfur into the root zone (8-10 inches deep). Apply the elemental sulfur at a rate of 8 pounds per 1000 square feet.

Till or otherwise mix to distribute the sulfur as uniformly as possible. Follow amendment by watering and keep soil moist over the subsequent several weeks to promote the acidification process.

Fertilizer Recommendations

Report

LATE SUMMER OR EARLY FALL is the best time to establish cool-season grasses. EARLY SPRING establishment can also be successful but is riskier and may require more input of effort and resources. N.J. law prohibits application of fertilizer containing nitrogen or phosphorus after November 15 (December 1 for professional certified applicators) and before March 1.

Target ratio for fertilizer product is: 1-1-1, which represents the fertilizer's relative amounts of nitrogen (N), phosphorus as P_2O_5 , and potassium as K_2O .

The estimated yearly nitrogen (N) need of this new seeding/sodding is 1 pound per 1000 square feet. New plantings allow mixing of the fertilizer into the soil to build up root zone fertility before planting.

DO THIS: Uniformly apply fertilizer(s) with N:P:K ratio indicated above to achieve 0.9 pound Nitrogen per 1000 square feet, and mix into soil depth of 4 inches.

TWO to FOUR WEEKS AFTER EMERGENCE of seedlings or placing sod, additional fertilizer is recommended to promote rapid establishment. If seeding/sodding in spring, this application should be repeated in September and October, at least 5 weeks apart; or for sandy soils, split applications into half-rate and apply four times, 3 weeks apart.

Rutgers Cooperative Extension encourages use of fertilizers having a water-insoluble nitrogen (WIN) component as specified on the label. WIN serves as a slow, extended release source of nitrogen. A gentle rain or light watering after application will help rinse fertilizer into the root zone, but do not apply fertilizer just prior to expected heavy rainfall to avoid loss of fertilizer and pollution of stormwater.

DO THIS: Using a 2:1:1 fertilizer, apply 0.75 pound Nitrogen per 1000 square feet spread uniformly over the turf.

WHAT ABOUT NEXT YEAR? In the 2nd year of establishment, two periods of fertilization are suggested: 1) April, and 2) September. Avoid applying fertilizer during very hot, very dry weather. For sandy soils, it is also suggested that each application be split into two doses spaced 3 to 5 weeks apart to minimize potential for leaching loss.

The fertilizer prescription above is intended to bring soil nutrients to optimal or near-optimal conditions, and subsequent management recommendations are intended to maintain soil nutrients levels near optimum. A gentle rain or light watering after application will help rinse fertilizer into the root zone, but do not apply fertilizer prior to expected heavy

rainfall to avoid loss of fertilizer and pollution of stormwater.

The best nutrient ratio for maintenance fertilization of the turf beyond 2 years is best determined by another soil test.

DO THIS: return grass clippings to the Turfgrass when mowing to recycle nutrients. Use fertilizer with N:P:K ratio of: 1:0:0 (nitrogen only) or 4:0:1 or 2:0:1 or 1:0:1 (representing increasing amounts of potassium; doses of potassium may be necessary for sandy, low organic matter soils) to achieve 0.75 pound Nitrogen per 1000 square feet.

How do I find the proper fertilizer product?

For help finding appropriate fertilizers and rates, consult the Rutgers Soil Testing Laboratory website: rci.rutgers.edu/~soilslab/FertProducts/. The website lists commercially available products according to their nutrient analyses to assist you with product selection and calculation of amount required.

Select a fertilizer that has a nutrient grade (also known as guaranteed minimum analysis) the same as or a multiple of the values recommended, or select a close match to that ratio. When no single fertilizer product matches or approximates the recommended N:P₂O₅:K₂O nutrient ratio, it will be necessary to use two or more fertilizers to reach the correct balance of nutrients. The proper amount of fertilizer to apply in a single application depends on the actual fertilizer grade of the fertilizer product selected, the total area (square feet) to be treated, and the total number of fertilizer applications to be made throughout the year.

Micronutrient Statements

Zinc does not appear to be a limiting factor. For information about zinc in soil for plant nutrition, see FS721.

Copper does not appear to be a limiting factor. As with most other micronutrients, copper availability is related to soil pH. Do not over-lime. For more information about soil copper, see FS720.

Manganese may be toxic to sensitive crops when grown on low pH soil. Adding lime to the soil raises the pH and decreases manganese toxicity. Liming is generally not recommended for acid-loving plants, which are more tolerant of high levels of manganese. In excessive amounts, soil manganese can cause plant damage. This occurs primarily in low pH soil. Lime soil as recommended to decrease availability of manganese to plants. Avoid fertilizers that contain manganese. See FS973 for more information.

Boron would not be a limiting factor for most plants. Plant types differ in their requirement for boron, however; certain fruit, vegetables, and field crops have greater need for boron (up to 0.75 ppm). For more information, see FS873.

Plant availability to iron is highly dependent on soil pH. Although soil iron appears plentiful, high soil pH could limit its availability. On the other hand, plant damage due to iron toxicity, though not common, could occur at low soil pH (acidic soil). Maintain soil pH in the optimum range as described in Recommendations. See FS971 for more information.

Comments:

Find Rutgers Cooperative Extension Fact Sheets at www.njaes.rutgers.edu/pubs



Soil Test Report Lab #: 2017-58200

ATC Group Services LLC
Scott McLaughlin
3 Terri Lane
Suite 4
Burlington, NJ 08016

Date Received: 2017-03-21

Date Reported: 2017-03-27

scott.mclaughlin@atcassociates.com
(609)479-8526
(609)386-7951(fax)

Crop or Plant

NewTurfgrass, cool season

Sample ID: ABC Barrel TS3

Results and Interpretations

Sandy Loam

pH: 7.76 Moderately alkaline; above optimum pH for most plants.

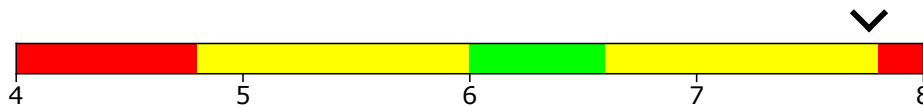

Macronutrients (pounds per acre)

by Mehlich 3 extraction

Phosphorus: 975 (Above Optimum)
Potassium: 5525 (Above Optimum)
Magnesium: 1487 (Above Optimum)
Calcium: 7478 (Above Optimum)

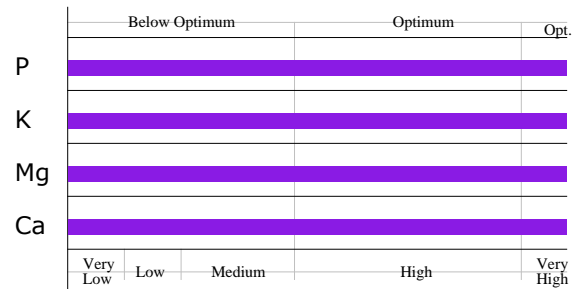

Micronutrients (parts per million)

Zinc(Zn) 15.34 (Adequate)	Copper(Cu) 2.59 (Adequate)	Manganese(Mn) 45.17 (High)	Boron(B) 5.30 (Adequate)	Iron(Fe) 417.00 (High)
-------------------------------------	--------------------------------------	--------------------------------------	------------------------------------	----------------------------------

Special Tests Results

Soluble Salts- Electrical conductivity= 3.19 mmho/cm
(Very High ; will 'burn' plant roots, causing drought-like symptoms)

Organic Matter by Carbon Analysis: Organic Matter=9.0%

Very High for Sandy Loam

Gravel Content- Larger than 2mm: 4.6%

Mechanical Analysis- Sand= 74% Silt=14% Clay= 12% Texture: Sandy Loam

Measured Cation Exchange Capacity: 15.08 meq/100g

pH, Calcium, and Magnesium Recommendations

The soil pH is higher than the optimum range of 6.00 to 6.60 for the growth of most Turfgrass, cool season. Do not apply any limestone, compost or wood ashes to the area.

Prior to new seeding/planting, soil pH should be adjusted by application and thorough mixing of powdered elemental sulfur into the root zone (8-10 inches deep). Apply the elemental sulfur at a rate of 12 pounds per 1000 square feet.

Till or otherwise mix to distribute the sulfur as uniformly as possible. Follow amendment by watering and keep soil moist over the subsequent several weeks to promote the acidification process.

Fertilizer Recommendations

Report

LATE SUMMER OR EARLY FALL is the best time to establish cool-season grasses. EARLY SPRING establishment can also be successful but is riskier and may require more input of effort and resources. N.J. law prohibits application of fertilizer containing nitrogen or phosphorus after November 15 (December 1 for professional certified applicators) and before March 1.

Target ratio for fertilizer product is: 1-1-1 ,which represents the fertilizer's relative amounts of nitrogen (N), phosphorus as P₂O₅, and potassium as K₂O.

The estimated yearly nitrogen (N) need of this new seeding/sodding is 1 pound per 1000 square feet. New plantings allow mixing of the fertilizer into the soil to build up root zone fertility before planting.

DO THIS: Uniformly apply fertilizer(s) with N:P:K ratio indicated above to achieve 0.9 pound Nitrogen per 1000 square feet, and mix into soil depth of 4 inches.

TWO to FOUR WEEKS AFTER EMERGENCE of seedlings or placing sod, additional fertilizer is recommended to promote rapid establishment. If seeding/sodding in spring, this application should be repeated in September and October, at least 5 weeks apart; or for sandy soils, split applications into half-rate and apply four times, 3 weeks apart.

Rutgers Cooperative Extension encourages use of fertilizers having a water-insoluble nitrogen (WIN) component as specified on the label. WIN serves as a slow, extended release source of nitrogen. A gentle rain or light watering after application will help rinse fertilizer into the root zone, but do not apply fertilizer just prior to expected heavy rainfall to avoid loss of fertilizer and pollution of stormwater.

DO THIS: Using a 2:1:1 fertilizer, apply 0.75 pound Nitrogen per 1000 square feet spread uniformly over the turf.

WHAT ABOUT NEXT YEAR? In the 2nd year of establishment, two periods of fertilization are suggested: 1) April, and 2) September. Avoid applying fertilizer during very hot, very dry weather. For sandy soils, it is also suggested that each application be split into two doses spaced 3 to 5 weeks apart to minimize potential for leaching loss.

The fertilizer prescription above is intended to bring soil nutrients to optimal or near-optimal conditions, and subsequent management recommendations are intended to maintain soil nutrients levels near optimum. A gentle rain or light watering after application will help rinse fertilizer into the root zone, but do not apply fertilizer prior to expected heavy

rainfall to avoid loss of fertilizer and pollution of stormwater.

The best nutrient ratio for maintenance fertilization of the turf beyond 2 years is best determined by another soil test.

DO THIS: return grass clippings to the Turfgrass when mowing to recycle nutrients. Use fertilizer with N:P:K ratio of: 1:0:0 (nitrogen only) or 4:0:1 or 2:0:1 or 1:0:1 (representing increasing amounts of potassium; doses of potassium may be necessary for sandy, low organic matter soils) to achieve 0.75 pound Nitrogen per 1000 square feet.

How do I find the proper fertilizer product?

For help finding appropriate fertilizers and rates, consult the Rutgers Soil Testing Laboratory website: rci.rutgers.edu/~soilslab/FertProducts/. The website lists commercially available products according to their nutrient analyses to assist you with product selection and calculation of amount required.

Select a fertilizer that has a nutrient grade (also known as guaranteed minimum analysis) the same as or a multiple of the values recommended, or select a close match to that ratio. When no single fertilizer product matches or approximates the recommended N:P₂O₅:K₂O nutrient ratio, it will be necessary to use two or more fertilizers to reach the correct balance of nutrients. The proper amount of fertilizer to apply in a single application depends on the actual fertilizer grade of the fertilizer product selected, the total area (square feet) to be treated, and the total number of fertilizer applications to be made throughout the year.

Micronutrient Statements

Zinc does not appear to be a limiting factor. For information about zinc in soil for plant nutrition, see FS721.

Copper does not appear to be a limiting factor. As with most other micronutrients, copper availability is related to soil pH. Do not over-lime. For more information about soil copper, see FS720.

Manganese may be toxic to sensitive crops when grown on low pH soil. Adding lime to the soil raises the pH and decreases manganese toxicity. Liming is generally not recommended for acid-loving plants, which are more tolerant of high levels of manganese. In excessive amounts, soil manganese can cause plant damage. This occurs primarily in low pH soil. Lime soil as recommended to decrease availability of manganese to plants. Avoid fertilizers that contain manganese. See FS973 for more information.

Boron would not be a limiting factor for most plants. Plant types differ in their requirement for boron, however; certain fruit, vegetables, and field crops have greater need for boron (up to 0.75 ppm). For more information, see FS873.

Plant availability to iron is highly dependent on soil pH. Although soil iron appears plentiful, high soil pH could limit its availability. On the other hand, plant damage due to iron toxicity, though not common, could occur at low soil pH (acidic soil). Maintain soil pH in the optimum range as described in Recommendations. See FS971 for more information.

Comments:

Find Rutgers Cooperative Extension Fact Sheets at www.njaes.rutgers.edu/pubs



Soil Test Report Lab #: 2017-58201

ATC Group Services LLC
Scott McLaughlin
3 Terri Lane
Suite 4
Burlington, NJ 08016

Date Received: 2017-03-21

Date Reported: 2017-03-27

scott.mclaughlin@atcassociates.com
(609)479-8526
(609)386-7951(fax)

Crop or Plant

Established Turfgrass, cool season

Sample ID: ABC Barrel TS4

Results and Interpretations

Sandy Loam

pH: 7.39 Slightly alkaline; above optimum pH for most plants.

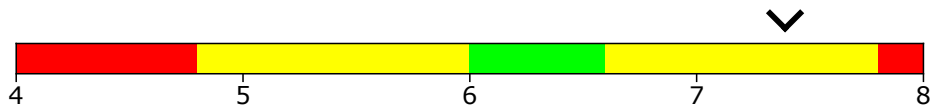

Macronutrients (pounds per acre)

by Mehlich 3 extraction

Phosphorus: 965 (Above Optimum)
Potassium: 4954 (Above Optimum)
Magnesium: 1333 (Above Optimum)
Calcium: 7104 (Above Optimum)

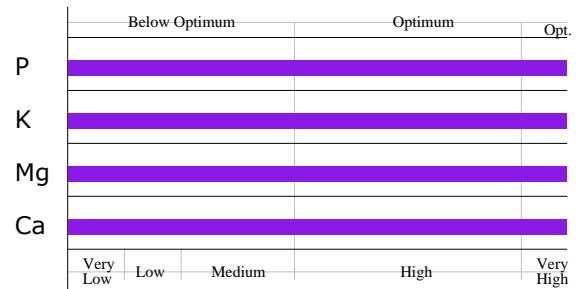

Micronutrients (parts per million)

Zinc(Zn) 23.82 (Adequate)	Copper(Cu) 5.40 (Adequate)	Manganese(Mn) 31.24 (High)	Boron(B) 4.82 (Adequate)	Iron(Fe) 425.00 (High)
-------------------------------------	--------------------------------------	--------------------------------------	------------------------------------	----------------------------------

Special Tests Results

Soluble Salts- Electrical conductivity= 3.84 mmho/cm
(Very High ; will 'burn' plant roots, causing drought-like symptoms)

Organic Matter by Carbon Analysis: Organic Matter=7.6%

Very High for Sandy Loam

Gravel Content- Larger than 2mm: 4.9%

Mechanical Analysis- Sand= 70% Silt=18% Clay= 12% Texture: Sandy Loam

Measured Cation Exchange Capacity: 14.05 meq/100g

pH, Calcium, and Magnesium Recommendations

The soil pH is higher than the optimum range of 6.00 to 6.60 for the growth of most Turfgrass, cool season. Do not apply any limestone, compost or wood ashes to the area.

For minimal disturbance of established plantings, a surface application of powdered elemental sulfur can be made to lower soil pH. Prior to application, expose and gently stir soil surface if possible. Apply sulfur at a maximum rate of 1 pound per 1000 square feet. Follow sulfur applications with frequent watering (if rainfall is not adequate) during subsequent weeks to keep the soil moist and distribute acidity to depth in the soil. Up to three applications may be made to established plantings in a growing season, with treatments at least 8 weeks apart. Re-test the soil pH before attempting additional adjustments.

Fertilizer Recommendations

Report

LATE AUGUST or EARLY SEPTEMBER (avoid very hot, very dry weather) is the best time to fertilize cool-season grasses. Otherwise, early Spring fertilization will suffice. Do not apply when grass is not growing (dormant). For sandy soils, split the application into two doses spaced 3 to 5 weeks apart to minimize potential for leaching loss. N.J. law prohibits application of fertilizer containing nitrogen or phosphorus after November 15 (December 1 for professional certified applicators) and before March 1.

Target ratio for fertilizer product is: 1-0-0, which represents the fertilizer's relative amounts of nitrogen (N), phosphorus as P_2O_5 , and potassium as K_2O .

The estimated yearly nitrogen (N) need of this crop/planting is 1 pound per 1000 square feet.

DO THIS: Uniformly apply fertilizer(s) with N:P:K ratio indicated above on the Turfgrass to achieve 0.75 pound Nitrogen per 1000 square feet (consult website for help with this). A gentle rain or light watering after application will help rinse fertilizer into the root zone, but do not apply fertilizer prior to expected heavy rainfall to avoid loss of fertilizer and pollution of stormwater.

WHAT ABOUT NEXT YEAR? If fertilizing only once per year, early fall (September) is preferred timing for turfgrass fertilization. Do not apply when grass is not growing (dormant). For sandy soils, it is also suggested the fertilizer application be split into two doses spaced 3 to 5 weeks apart to minimize potential for leaching loss.

The fertilizer prescription above is intended to bring soil nutrients to optimal or near-optimal conditions, and subsequent management recommendations are intended to maintain soil nutrients levels near optimum. The best nutrient ratio for maintenance fertilization of the turf beyond 2 years is best determined by another soil test.

DO THIS: return grass clippings to the Turfgrass when mowing to recycle nutrients. Use fertilizer with N:P:K ratio of: 1:0:0 (nitrogen only) or 4:0:1 or 2:0:1 or 1:0:1 (representing increasing amounts of potassium; supplemental potassium may be necessary for sandy, low organic matter soils) to achieve 0.75 pound Nitrogen per 1000 square feet.

How do I find the proper fertilizer product?

For help finding appropriate fertilizers and rates, consult the Rutgers Soil Testing Laboratory website: rci.rutgers.edu/~soilslab/FertProducts/. The website lists commercially available products according to their nutrient analyses to assist you with product selection and calculation of amount required.

Select a fertilizer that has a nutrient grade (also known as guaranteed minimum analysis) the same as or a multiple of the values recommended, or select a close match to that ratio. When no single fertilizer product matches or approximates the recommended N:P₂O₅:K₂O nutrient ratio, it will be necessary to use two or more fertilizers to reach the correct balance of nutrients. The proper amount of fertilizer to apply in a single application depends on the actual fertilizer grade of the fertilizer product selected, the total area (square feet) to be treated, and the total number of fertilizer applications to be made throughout the year.

Micronutrient Statements

Zinc does not appear to be a limiting factor. For information about zinc in soil for plant nutrition, see FS721.

Copper does not appear to be a limiting factor. As with most other micronutrients, copper availability is related to soil pH. Do not over-lime. For more information about soil copper, see FS720.

Manganese may be toxic to sensitive crops when grown on low pH soil. Adding lime to the soil raises the pH and decreases manganese toxicity. Liming is generally not recommended for acid-loving plants, which are more tolerant of high levels of manganese. In excessive amounts, soil manganese can cause plant damage. This occurs primarily in low pH soil. Lime soil as recommended to decrease availability of manganese to plants. Avoid fertilizers that contain manganese. See FS973 for more information.

Boron would not be a limiting factor for most plants. Plant types differ in their requirement for boron, however; certain fruit, vegetables, and field crops have greater need for boron (up to 0.75 ppm). For more information, see FS873.

Plant availability to iron is highly dependent on soil pH. Although soil iron appears plentiful, high soil pH could limit its availability. On the other hand, plant damage due to iron toxicity, though not common, could occur at low soil pH (acidic soil). Maintain soil pH in the optimum range as described in Recommendations. See FS971 for more information.

Comments:

Find Rutgers Cooperative Extension Fact Sheets at www.njaes.rutgers.edu/pubs



Soil Test Report Lab #: 2017-58202

ATC Group Services LLC
Scott McLaughlin
3 Terri Lane
Suite 4
Burlington, NJ 08016

Date Received: 2017-03-21

Date Reported: 2017-03-27

scott.mclaughlin@atcassociates.com
(609)479-8526
(609)386-7951(fax)

Crop or Plant

NewTurfgrass, cool season

Sample ID: ABC Barrel TS5

Results and Interpretations

Sandy Loam

pH: 7.60 Moderately alkaline; above optimum pH for most plants.

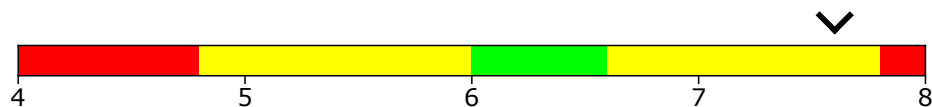

Macronutrients (pounds per acre)

by Mehlich 3 extraction

Phosphorus: 962 (Above Optimum)
Potassium: 5344 (Above Optimum)
Magnesium: 1318 (Above Optimum)
Calcium: 7519 (Above Optimum)

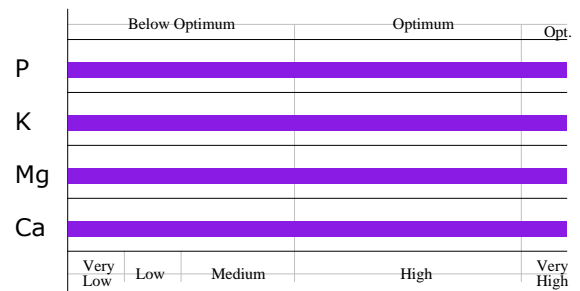

Micronutrients (parts per million)

Zinc(Zn) 21.53 (Adequate)	Copper(Cu) 4.74 (Adequate)	Manganese(Mn) 35.91 (High)	Boron(B) 4.55 (Adequate)	Iron(Fe) 418.70 (High)
-------------------------------------	--------------------------------------	--------------------------------------	------------------------------------	----------------------------------

Special Tests Results

Soluble Salts- Electrical conductivity= 4.01 mmho/cm
(Very High ; will 'burn' plant roots, causing drought-like symptoms)

Organic Matter by Carbon Analysis: Organic Matter=9.4%

Very High for Sandy Loam

Gravel Content- Larger than 2mm: 4.4%

Mechanical Analysis- Sand= 66% Silt=20% Clay= 14% Texture: Sandy Loam

Measured Cation Exchange Capacity: 14.98 meq/100g

pH, Calcium, and Magnesium Recommendations

The soil pH is higher than the optimum range of 6.00 to 6.60 for the growth of most Turfgrass, cool season. Do not apply any limestone, compost or wood ashes to the area.

Prior to new seeding/planting, soil pH should be adjusted by application and thorough mixing of powdered elemental sulfur into the root zone (8-10 inches deep). Apply the elemental sulfur at a rate of 12 pounds per 1000 square feet.

Till or otherwise mix to distribute the sulfur as uniformly as possible. Follow amendment by watering and keep soil moist over the subsequent several weeks to promote the acidification process.

Fertilizer Recommendations

Report

LATE SUMMER OR EARLY FALL is the best time to establish cool-season grasses. EARLY SPRING establishment can also be successful but is riskier and may require more input of effort and resources. N.J. law prohibits application of fertilizer containing nitrogen or phosphorus after November 15 (December 1 for professional certified applicators) and before March 1.

Target ratio for fertilizer product is: 1-1-1, which represents the fertilizer's relative amounts of nitrogen (N), phosphorus as P_2O_5 , and potassium as K_2O .

The estimated yearly nitrogen (N) need of this new seeding/sodding is 1 pound per 1000 square feet. New plantings allow mixing of the fertilizer into the soil to build up root zone fertility before planting.

DO THIS: Uniformly apply fertilizer(s) with N:P:K ratio indicated above to achieve 0.9 pound Nitrogen per 1000 square feet, and mix into soil depth of 4 inches.

TWO to FOUR WEEKS AFTER EMERGENCE of seedlings or placing sod, additional fertilizer is recommended to promote rapid establishment. If seeding/sodding in spring, this application should be repeated in September and October, at least 5 weeks apart; or for sandy soils, split applications into half-rate and apply four times, 3 weeks apart.

Rutgers Cooperative Extension encourages use of fertilizers having a water-insoluble nitrogen (WIN) component as specified on the label. WIN serves as a slow, extended release source of nitrogen. A gentle rain or light watering after application will help rinse fertilizer into the root zone, but do not apply fertilizer just prior to expected heavy rainfall to avoid loss of fertilizer and pollution of stormwater.

DO THIS: Using a 2:1:1 fertilizer, apply 0.75 pound Nitrogen per 1000 square feet spread uniformly over the turf.

WHAT ABOUT NEXT YEAR? In the 2nd year of establishment, two periods of fertilization are suggested: 1) April, and 2) September. Avoid applying fertilizer during very hot, very dry weather. For sandy soils, it is also suggested that each application be split into two doses spaced 3 to 5 weeks apart to minimize potential for leaching loss.

The fertilizer prescription above is intended to bring soil nutrients to optimal or near-optimal conditions, and subsequent management recommendations are intended to maintain soil nutrients levels near optimum. A gentle rain or light watering after application will help rinse fertilizer into the root zone, but do not apply fertilizer prior to expected heavy

rainfall to avoid loss of fertilizer and pollution of stormwater.

The best nutrient ratio for maintenance fertilization of the turf beyond 2 years is best determined by another soil test.

DO THIS: return grass clippings to the Turfgrass when mowing to recycle nutrients. Use fertilizer with N:P:K ratio of: 1:0:0 (nitrogen only) or 4:0:1 or 2:0:1 or 1:0:1 (representing increasing amounts of potassium; doses of potassium may be necessary for sandy, low organic matter soils) to achieve 0.75 pound Nitrogen per 1000 square feet.

How do I find the proper fertilizer product?

For help finding appropriate fertilizers and rates, consult the Rutgers Soil Testing Laboratory website: rci.rutgers.edu/~soilslab/FertProducts/. The website lists commercially available products according to their nutrient analyses to assist you with product selection and calculation of amount required.

Select a fertilizer that has a nutrient grade (also known as guaranteed minimum analysis) the same as or a multiple of the values recommended, or select a close match to that ratio. When no single fertilizer product matches or approximates the recommended N:P₂O₅:K₂O nutrient ratio, it will be necessary to use two or more fertilizers to reach the correct balance of nutrients. The proper amount of fertilizer to apply in a single application depends on the actual fertilizer grade of the fertilizer product selected, the total area (square feet) to be treated, and the total number of fertilizer applications to be made throughout the year.

Micronutrient Statements

Zinc does not appear to be a limiting factor. For information about zinc in soil for plant nutrition, see FS721.

Copper does not appear to be a limiting factor. As with most other micronutrients, copper availability is related to soil pH. Do not over-lime. For more information about soil copper, see FS720.

Manganese may be toxic to sensitive crops when grown on low pH soil. Adding lime to the soil raises the pH and decreases manganese toxicity. Liming is generally not recommended for acid-loving plants, which are more tolerant of high levels of manganese. In excessive amounts, soil manganese can cause plant damage. This occurs primarily in low pH soil. Lime soil as recommended to decrease availability of manganese to plants. Avoid fertilizers that contain manganese. See FS973 for more information.

Boron would not be a limiting factor for most plants. Plant types differ in their requirement for boron, however; certain fruit, vegetables, and field crops have greater need for boron (up to 0.75 ppm). For more information, see FS873.

Plant availability to iron is highly dependent on soil pH. Although soil iron appears plentiful, high soil pH could limit its availability. On the other hand, plant damage due to iron toxicity, though not common, could occur at low soil pH (acidic soil). Maintain soil pH in the optimum range as described in Recommendations. See FS971 for more information.

Comments:

Find Rutgers Cooperative Extension Fact Sheets at www.njaes.rutgers.edu/pubs



March 1, 2018



Mr . Julian Heal
Ambient Group
222 Thies Road
Sewell , NJ 08080

Re: Topsoil Letter

Dear Mr. Heal :

This letter is to certify that the soil you purchased from SLF Trucking for use at ABC Barrel was tested and those results were submitted to your customer to determine that the soil met the NJ Residential Soil Remediation Standards.

The topsoil meets the NJ Residential Direct Contact standards and is determined to be clean.

Please feel free to contact me with any questions or concerns.

Regards ,

A handwritten signature in black ink that reads "Rick O'Brien".

Rick O'Brien

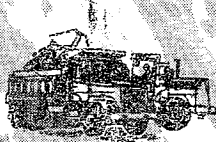

STEVEN L. FOSTER, LLC
 1084 ROUTE 45
 PILESGROVE, NJ 08098
 (856) 769-1879 Fax (856) 769-8124

#025

CUSTOMER'S ORDER NO. _____ PHONE _____ DATE **4-21-17**

NAME _____

ADDRESS **AMBERNT**

330 N. FRONT ST

CAMDEN

SOLD BY	CASH	C.O.D.	CHARGE	ON ACCT.	MOSE. RET'D.	PAID OUT
TOM						

QTY.	DESCRIPTION	PRICE	AMOUNT
------	-------------	-------	--------

20 YD	TOPSOIL		
--------------	----------------	--	--

20 YD			
--------------	--	--	--

20 YD			
--------------	--	--	--

--	--	--	--

--	--	--	--

--	--	--	--

--	--	--	--

--	--	--	--

--	--	--	--

	3 LOADS		
--	----------------	--	--

--	--	--	--

--	--	--	--

--	--	--	--

--	--	--	--

--	--	--	--

--	--	--	--

--	--	--	--

--	--	--	--

--	--	--	--

--	--	--	--

RECEIVED BY _____		TAX	
-------------------	--	------------	--

		TOTAL	
--	--	--------------	--

21542 All claims and returned goods MUST be accompanied by this bill.

THANK YOU

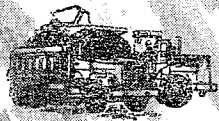

STEVEN L. FOSTER, LLC

1084 ROUTE 45
PIESGROVE, NJ 08098
(856) 769-1879 Fax (856) 769-8124

#025

CUSTOMER'S ORDER NO. _____ PHONE _____ DATE 4-24-17

NAME _____

ADDRESS AMBIENT

FRONT ST

CAMDEN

SOLD BY	CASH	C.O.D.	CHARGE	ON ACCT.	MDSE. RET'D.	PAID OUT
<u>TOM</u>						

QTY.	DESCRIPTION	PRICE	AMOUNT
------	-------------	-------	--------

<u>20 YD</u>	<u>TOP SOIL</u>		
	<u>KD</u>		

<u>20 YD</u>	<u>KT</u>		
--------------	----------------------	--	--

<u>20 YD</u>	<u>KT</u>		
--------------	----------------------	--	--

<u>20 YD</u>	<u>KT</u>		
--------------	----------------------	--	--

<u>20 YD</u>	<u>KT</u>		
--------------	----------------------	--	--

<u>20 YD</u>	<u>KT</u>		
--------------	----------------------	--	--

(6)
LOADS

RECEIVED BY _____ TAX _____

TOTAL _____

21543

All claims and returned goods MUST be accompanied by this bill.

THANK YOU

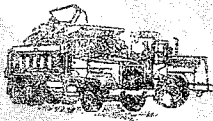

STEVEN L. FOSTER, LLC
1084 ROUTE 45
PIESGROVE, NJ 08098
(856) 769-1879 Fax (856) 769-8124

CUSTOMER'S ORDER NO. _____ PHONE _____ DATE 4-24-17

NAME _____

ADDRESS Ambient

2nd St Lakewood MS

SOLD BY	CASH	C.O.D.	CHARGE	ON ACCT.	MDSE. RET'D.	PAID OUT	#5
---------	------	--------	--------	----------	--------------	----------	----

QTY.	DESCRIPTION	PRICE	AMOUNT
------	-------------	-------	--------

20yds	Topsoil	0.25	5.00
20yds	Topsoil	0.25	5.00
20yds	Topsoil	0.25	5.00
20yds	Topsoil	0.25	5.00
20yds	Topsoil	0.25	5.00
20yds	Topsoil	0.25	5.00

6 loads

RECEIVED BY _____ TAX _____

TOTAL _____

6067

All claims and returned goods MUST be accompanied by this bill.

THANK YOU

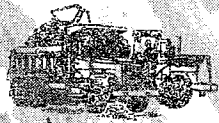

STEVEN L. FOSTER, LLC

1084 ROUTE 45
PILES GROVE, NJ 08098
(856) 769-1879 Fax (856) 769-8124

H 025

CUSTOMER'S ORDER NO.

PHONE

DATE

4-27-17

NAME

ADDRESS

AMBIENT
FRONT ST
CAMDEN

SOLD BY TOM	CASH	C.O.D.	CHARGE	ON ACCT.	MDSE. RET'D.	PAID OUT
----------------	------	--------	--------	----------	--------------	----------

QTY.	DESCRIPTION	PRICE	AMOUNT
20 YD	TOPSOIL KA		
20 YD	KA		
20 YD	KA		
20 YD	KA		
20 YD	KA		
	6		

RECEIVED BY

TAX

TOTAL

21546

All claims and returned goods MUST be accompanied by this bill.

THANK YOU

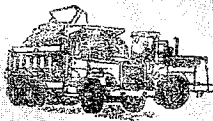

STEVEN L. FOSTER, LLC
 1084 ROUTE 45
 PILESGROVE, NJ 08098
 (856) 769-1879 Fax (856) 769-8124

CUSTOMER'S ORDER NO. _____ PHONE _____ DATE 4.27.17

NAME _____

ADDRESS Ambient

2nd St

Camden NJ

SOLD BY	CASH	C.O.D.	CHARGE	ON ACCT.	MDSE. RET'D.	PAID OUT	<u># 5</u>
---------	------	--------	--------	----------	--------------	----------	------------

QTY.	DESCRIPTION	PRICE	AMOUNT
------	-------------	-------	--------

	<u>Top Soil</u>		
<u>20 yds</u>	<u>(Signature)</u>		
<u>20 yds</u>	<u>(Signature)</u>		
<u>20 yds</u>	<u>(Signature)</u>		
<u>20 yds</u>	<u>(Signature)</u>		
<u>20 yds</u>	<u>(Signature)</u>		
	<u>5 loads</u>		

RECEIVED BY _____	TAX _____
	TOTAL _____

6068

All claims and returned goods MUST be accompanied by this bill.

THANK YOU



STEVEN L. FOSTER, LLC
SLF TRUCKING, LLC
1084 ROUTE 45
PIESGROVE, NJ 08098
(856) 769-1879 Fax (856) 769-8124

CUSTOMER'S ORDER NO.

PHONE

DATE

April 27 2017

NAME

Ambient

ADDRESS

FRONT ST

CAMDEN, NJ

SOLD BY

CASH

C.O.D.

CHARGE

ON ACCT.

MDSE. RET'D.

PAID OUT

QTY.

DESCRIPTION

PRICE

AMOUNT

20 yds

20 yds

20 yds

20 yds

20 yds

5 LOADS

RECEIVED BY

TAX

TOTAL

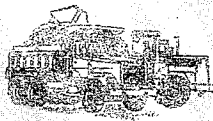

STEVEN L. FOSTER, LLC
 1084 ROUTE 45
 PILESGROVE, NJ 08098
 (856) 769-1879 Fax (856) 769-8124

CUSTOMER'S ORDER NO.	PHONE	DATE 4-28-17
NAME Ambient		
ADDRESS 2nd St Landon NJ		

SOLD BY	CASH	C.O.D.	CHARGE	ON ACCT.	MDSE. RET'D.	PAID OUT	#5
---------	------	--------	--------	----------	--------------	----------	----

QTY.	DESCRIPTION	PRICE	AMOUNT
	TOP SOIL		
20 yds	Top Soil		
20 yds	Top Soil		
20 yds	Top Soil		
20 yds	Top Soil		
	4 loads		
RECEIVED BY		TAX	
		TOTAL	

6069

All claims and returned goods MUST be accompanied by this bill.

THANK YOU



STEVEN L. FOSTER, LLC

1084 ROUTE 45

PILES GROVE, NJ 08098

(856) 769-1879 Fax (856) 759-8124

025

CUSTOMER'S ORDER NO.

PHONE

DATE

5-1-17

NAME

ADDRESS

AMBIENT
FRONT ST
CAMDEN

SOLD BY

TOM

CASH

C.O.D.

CHARGE

ON ACCT.

MDSE. RET'D.

PAID OUT

QTY.

DESCRIPTION

PRICE

AMOUNT

20 YD

TOPSOIL

20 YD

11

RECEIVED BY

TAX

TOTAL

21549

All claims and returned goods MUST be accompanied by this bill.

THANK YOU

APPENDIX H
THIRD-PARTY DATA REVIEW





May 24, 2017

Mr. Charles Metzger
BRS, Inc.
P.O. Box 2293
Medford Lakes, NJ 08055

RE: ABC Barrel

Dear Mr. Metzger:

The evaluation of the data prepared by Phoenix Environmental Laboratories, Inc. for 16 soil samples, and two trip blanks (TBs) from the ABC Barrel Site, which were reported in five data packages under Sample Delivery Group Nos. GBX79135, GBX79142, GBX87625, GBX96078, and GBX96643 has been completed. The electronic data packages were received by ddms, inc. (ddms) for review, and the following samples were reported:

SDG # GBX79135

(PCE, TCE, DCE, VC only + 15)

AOCG-B	AOCG-B DUP	AOCG-S1	AOCG-S2	AOCG-S3
AOCG-S4	TRIP BLANK	TRIP BLANK HIGH		

SDG # GBX79142

(EPH Cat 1)

AOCB2-S1	AOCB2-S2	AOCB2-S3	AOCB2-S4	AOCB2-S4 DUP
AOCB2-B				

SDG # GBX87625

(TCL-PAH, TAL metals)

RA-2B	RA-2B DUP
-------	-----------

SDG # GBX96078

(TCL-PAH, TAL metals)

RA-1B

SDG # GBX96643

(TCL-PAH, TAL metals)

RA-3B

The data quality assessment was performed in accordance with New Jersey Department of Environmental Protection (NJDEP) Site Remediation Program, Data of Known Quality Protocols and Data Quality Assessment and Data Usability Evaluation Technical Guidance documents.

The following components were reviewed, where applicable:

- Chain of Custody
- Receiving conditions
- Holding times

- Preservation
- Analyte lists
- Reporting limits
- Requested methods
- Units, and
- Sample related quality control data:
 - Method blanks
 - Field blanks
 - LCS/LCSD recoveries
 - MS/MSD recoveries
 - Serial dilutions (metals only)
 - Interference check standards
 - Field duplicates
- Instrument related quality control data:
 - Calibration data
 - Calibration blank data
 - Tune summaries (organics)

The NJDEP Data Quality Assessment Worksheet summarizes the quality control excursion(s) detected during the assessment process, the samples associated with the QC excursion and the potential impact to the sample results. This is located in Attachment A. Located in Attachment B are the Data Usability Evaluation (DUE) Worksheet and DUE Summary. Tables summarizing the qualifiers applied to the data as a result of the review as well as comparison to the appropriate screening criteria are in Attachment C.

Please feel free to contact me with any questions you may have regarding this report.

Sincerely,

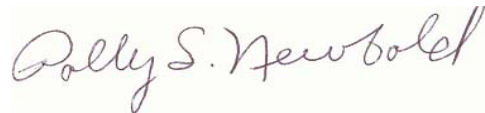

Polly S. Newbold
Sr. Environmental Chemist

Attachments

Attachment A



Modified NJDEP DATA QUALITY ASSESSMENT WORKSHEET

Date: May 24, 2017

Project: ABC Barrel Site

Laboratory Work Orders: GBX79135, GBX79142, GBX87625, GBX96078, GBX96643

Analytical Methods: SW846 8260, EPH, SW846 8270D, SW846 6010C, SW846 7471

Reviewer: Polly S. Newbold, ddms, inc.

The tables below document only the Quality Control (QC) excursions that impacted sample results. QC excursions that had no impact to sample results are not discussed.

Surrogates	Analyte	%R	Affected Samples	Comments
SDG GBX79142				
	COD	56	AOCB2-B	All EPH results were qualified as estimated (UJ) due to low surrogate recoveries (acceptance limits 70-130%). Results may be biased low.
	Terphenyl-d14	66	AOCB2-S4 DUP	
SDG GBX87625				
	2-Fluorobiphenyl	58	RA-2B	All PAH results were qualified as estimated (UJ) due to low surrogate recoveries (acceptance limits 70-130%). Results may be biased low.
	Nitrobenzene-d5	51		
	2-Fluorobiphenyl	54	RA-2B DUP	
	Nitrobenzene-d5	49		
	Terphenyl-d14	64		



MS/MSD Recovery	Analyte	MS %R	MSD%R	Affected Sample(s)	High/Low or Indeterminate Bias	Comments
SDG GBX87625						
RA-2B	Naphthalene	41		RA-2B RA-2B Dup	Low	Results were qualified as estimated (J, UJ) due to low MS recoveries (acceptance limits 70-130%). Results may be biased low or there may be false negatives. NOTE: MS only. No MSD performed.
	2-Methylnaphthalene	42				
	Acenaphthylene	44				
	Acenaphthene	46				
	Fluorene	47				
	Phenanthrene	48				
	Anthracene	50				
	Fluoranthene	49				
	Pyrene	51				
	Benz(a)anthracene	47				
	Chrysene	50				
	Benzo(b)fluoranthene	49				
	Benzo(k)fluoranthene	50				
	Benzo(a)pyrene	46				
Indeno(1,2,3-cd)pyrene	48					
Dibenz(a,h)anthracene	49					
Benzo(ghi)perylene	49					
SDG BX96643						
RA-3B	Naphthalene	69	68	RA-3B	Low	Results were qualified as estimated (J, UJ) due to low MS and/or MSD recoveries (acceptance limits 70-130%). Results may be biased low or there may be false negatives.
	2-Methylnaphthalene	67	67			
	Acenaphthylene	67	67			
	Benzo(a)pyrene		67			



LCS Recovery	Analyte	LCS %R		Affected Sample(s)	High/Low or Indeterminate Bias	Comments
SDG GBX87625						
	Naphthalene	58	63	RA-2B RA-2B Dup	Low	Results were qualified as estimated (J, UJ) due to low LCS/LCSD recoveries (acceptance limits 70-130%). Results may be biased low or there may be false negatives.
	2-Methylnaphthalene	61	63			
	Acenaphthylene	65	67			
	Acenaphthene	67				
	Fluorene	67	69			
	Phenanthrene	68				
	Benz(a)anthracene	69				
	Benzo(a)pyrene	67	68			
SDG SBX96078						
	Naphthalene	67	58	RA-1B	Low	Results were qualified as estimated (J, UJ) due to low LCS recoveries (acceptance limits 70-130%). Results may be biased low or there may be false negatives.
	2-Methylnaphthalene	66	57			
	Acenaphthylene	68	57			
	Acenaphthene		62			
	Fluorene		61			
	Phenanthrene		63			
	Anthracene		64			
	Fluoranthene		64			
	Pyrene		66			
	Benz(a)anthracene		62			
	Chrysene		68			
	Benzo(b)fluoranthene		64			
	Benzo(k)fluoranthene		63			
	Benzo(a)pyrene		61			
	Indeno(1,2,3-cd)pyrene		65			
	Dibenz(a,h)anthracene		64			
	Benzo(ghi)perylene		69			
SDG SBX96643						
	2-Methylnaphthalene	66		RA-3B	Low	Results were qualified as estimated (J, UJ) due to low LCS recoveries (acceptance limits 70-130%). Results may be biased low or there may be false negatives.



ICP Interference Check Sample (ICS)					
	Analyte	%R	Samples Affected	Bias	Comments
SDG GBX 87625					
	Sodium	77.1	RA-2B RA-2B DUP	Low	The results for sodium were qualified estimated (J, UJ) due to low ICS recoveries (acceptance limits 80-120%). Results may be biased low or there may be false negatives.

IC – Initial Calibration

CCV – Continuing Calibration Standard.

RL – Reporting Limit



Attachment B

DATA USABILITY SUMMARY

Date: May 24, 2017

Project: ABC Barrel Site

Laboratory Work Order(s): GBX79135, GBX79142, GBX87625, GBX96078, GBX96643

The data usability assessment was performed in accordance with New Jersey Department of Environmental Protection (NJDEP) Site Remediation Program, Data of Known Quality Protocols and Data Quality Assessment and Data Usability Evaluation Technical Guidance documents. Professional judgment was applied as necessary and appropriate. The data quality assessment and subsequent data usability evaluation is based on sample-related QC excursions as well as the review of instrument related QC, including tunes and calibrations, sample chromatograms and spectra, if provided. Sample calculations were not performed.

At the client's request, the analyte list for volatiles was limited to cis-1,2-Dichloroethene, Tetrachloroethene, Trichloroethene, and Vinyl chloride. The analyte list for semi-volatiles was limited to 17 PAH compounds. Documentation of the modifications to the compound lists was provided in the data packages.

Attached to this data usability summary and worksheet, in Attachment C, is a table summarizing the analytical results with a comparison to the NJDEP Groundwater Quality Standards (GWQS) or Soil Remediation Standards (SRS), where applicable, and the qualifications to the data made during the data quality assessment effort. It should be noted that this data usability summary does not address how the data are to be used, whether Data Quality Objectives (DQOs) have been met or applicability to the Conceptual Site Model (CSM), all of which are outside the purview of this effort.

Only those findings that have impact to the data quality are summarized below:

- Results for EPH results in AOCB2-S4 DUP and AOCB2-B were qualified as estimated (UJ) due to low surrogate recoveries (acceptance limits 70-130%). Results may be biased low.
- All PAH results in RA-1B, RA-2B, and RA-2B DUP were qualified as estimated (UJ) due to low surrogate recoveries, low LCS recoveries, and/or low MS/MSD recoveries (acceptance limits 70-130%). Results may be biased low.
- Results for Naphthalene, 2-Methylnaphthalene, Acenaphthylene, and Benzo(a)pyrene in RA-3B were qualified as estimated (J, UJ) due to low MS and/or MSD recoveries (acceptance limits 70-130%). The result for 2-Methylnaphthalene in RA-3B was qualified estimated (UJ) due to a low LCS recovery. Results may be biased low or there may be false negatives.
- The results for Sodium in RA-2B and RA-2B DUP were qualified estimated (J, UJ) due to low ICS recoveries (acceptance limits 80-120%). Results may be biased low or there may be false negatives.

- The reporting limits for Benzo(a)pyrene and Dibenz(a,h)anthracene in RA-1B, RA-2B, RA-2B DUP, and RA-3B were raised to 230 µg/Kg (uncorrected) because that is the lowest concentration at which accurate quantitation is supported by the IC.

DATA QUALIFIERS AND DEFINITIONS

U	The analyte was analyzed for, but was not detected above the level of the reported sample quantitation limit.
J	The result is an estimated quantity. The associated numerical value is the approximate concentration of the analyte in the sample.
UJ	The analyte was analyzed for, but was not detected. The reported quantitation limit is approximate and may be inaccurate or imprecise.
R	The data are unusable. The sample results are rejected due to serious deficiencies in meeting QC criteria. The analyte may or may not be present in the sample.

DATA USABILITY EVALUATION WORKSHEET

Project Name: ABC Barrel Site
Laboratory: Phoenix Environmental Laboratories, Inc
Sample Delivery Group(s): GBX79135, GBX79142, GBX87625, GBX96078, and GBX96643
Date(s) Samples Collected: 2/28/2017, 3/1/2017, 3/15/2017, 3/26/2017, and 3/30/2017
Reviewer: Polly S. Newbold, ddms, inc.

Describe the intended use of the data:	
Nonconformance DQA Review Elements	Briefly Summarize DQA Non-conformances
Laboratory Report Inspection	
Reasonable Confidence Evaluation	
Chain of Custody Evaluation	
Sample Result Evaluation	
Sample Preservation and Holding Time Evaluation	
Blank Evaluation	
Laboratory Control Samples	Results were qualified as estimated due to LCS excursions. Refer to DQA Worksheet for details.
Surrogates	
Site Specific Matrix Spikes and Matrix Spike Duplicates	Results were qualified as estimated due to MS/MSD excursions. Refer to DQA Worksheet for details.
Tentatively Identified Compounds	
Other QC data	Results were qualified as estimated due to surrogate recoveries. The results for sodium were qualified estimated (J, UJ) due to low ICS recoveries (acceptance limits 80-120%). Results may be biased low or there may be false negatives. Refer to DQA Worksheet for details. Reporting limits were raised for Benzo(a)pyrene and Dibenz(a,h)anthracene to the lowest concentration that is supported by the IC.

Attachment C



Project Id : ABC BARREL	Lab Sample Id			BX79135				BX79136				BX79137				
	Collection Date	Client Id	Matrix	3/1/2017				3/1/2017				3/1/2017				
	CAS	Units	NJ-IGW Cleanup	NJ-Soil Res.	Result	RL	Qual	MDL	Result	RL	Qual	MDL	Result	RL	Qual	MDL
Miscellaneous/Inorganics																
Percent Solid	PHNX - PCTSOLID	%			89				89				90			
Volatiles By SW8260C																
cis-1,2-Dichloroethene	156-59-2	ug/Kg	1,000	230,000	< 5.7	5.7	U	0.57	< 4.8	4.8	U	0.48	< 5.8	5.8	U	0.58
Tetrachloroethene	127-18-4	ug/Kg	1,000	2,000	< 5.7	5.7	U	1.1	< 4.8	4.8	U	0.96	< 5.8	5.8	U	1.2
Trichloroethene	79-01-6	ug/Kg	1,000	7,000	< 5.7	5.7	U	0.57	< 4.8	4.8	U	0.48	< 5.8	5.8	U	0.58
Vinyl chloride	75-01-4	ug/Kg	10,000	700	< 5.7	5.7	U	0.57	< 4.8	4.8	U	0.48	< 5.8	5.8	U	0.58

Result Detected

RL Exceeds Criteria

Result Exceeds Criteria



Project Id : ABC BARREL	Lab Sample Id	Units	NJ-IGW Cleanup	NJ-Soil Res.	BX79138				BX79139				BX79140				
	CAS				Collection Date	Result	RL	Qual	MDL	Result	RL	Qual	MDL	Result	RL	Qual	MDL
	Client Id																
	Matrix																
	CAS																
	PHNX - PCTOLID	%			90					90				94			
Miscellaneous/Inorganics																	
Percent Solid																	
Volatiles By SW8260C																	
cis-1,2-Dichloroethene	156-59-2	ug/Kg	1,000	230,000	< 5.5	5.5	U	0.55	< 5.6	5.6	U	0.56	< 5.5	5.5	U	0.55	
Tetrachloroethene	127-18-4	ug/Kg	1,000	2,000	< 5.5	5.5	U	1.1	< 5.6	5.6	U	1.1	< 5.5	5.5	U	1.1	
Trichloroethene	79-01-6	ug/Kg	1,000	7,000	< 5.5	5.5	U	0.55	< 5.6	5.6	U	0.56	< 5.5	5.5	U	0.55	
Vinyl chloride	75-01-4	ug/Kg	10,000	700	< 5.5	5.5	U	0.55	< 5.6	5.6	U	0.56	< 5.5	5.5	U	0.55	

Result Detected

RL Exceeds Criteria

Result Exceeds Criteria



Lab Sample Id
Collection Date
Client Id
Matrix

BX79142
2/28/2017
AOCB2-S1
Soil

BX79143
2/28/2017
AOCB2-S2
Soil

BX79144
2/28/2017
AOCB2-S3
Soil

BX79145
2/28/2017
AOCB2-S4
Soil

Project Id : ABC BARREL

CAS	Units	Result	RL	Qual	MDL	Result	RL	Qual	MDL	Result	RL	Qual	MDL	Result	RL	Qual	MDL	
Miscellaneous/Inorganics																		
Percent Solid	PHNX - PCTSOLID	%	88			89				92				87				
NJ EPH Category 1 (Fuel #2/Diesel) By NJEPH 10-08 R3																		
>C28-C40	PHNX - C28-C40	mg/kg	< 280	280	U	280	< 280	280	U	280	< 53	53	U	53	< 280	280	U	280
C9-C28	PHNX - C9-C28	mg/kg	< 280	280	U	280	< 280	280	U	280	< 53	53	U	53	< 280	280	U	280
Total EPH	PHNX - TOT EPH	mg/kg	< 280	280	U	280	< 280	280	U	280	< 53	53	U	53	< 280	280	U	280

Result Detected



Lab Sample Id
Collection Date
Client Id
Matrix

BX79146
2/28/2017
AOCB2-S4 DUP
Soil

BX79147
2/28/2017
AOCB2-B
Soil

Project Id : ABC BARREL

CAS	Units	Result	RL	Qual	MDL	Result	RL	Qual	MDL	
Miscellaneous/Inorganics										
Percent Solid	PHNX - PCTSOLID	%	88			88				
NJ EPH Category 1 (Fuel #2/Diesel) By NJEPH 10-08 R3										
>C28-C40	PHNX - C28-C40	mg/kg	< 280	280	UJ	280	< 280	280	UJ	280
C9-C28	PHNX - C9-C28	mg/kg	< 280	280	UJ	280	< 280	280	UJ	280
Total EPH	PHNX - TOT EPH	mg/kg	< 280	280	UJ	280	< 280	280	UJ	280

Result Detected



Lab Sample Id
Collection Date
Client Id
Matrix

BX79141
2/28/2017
TRIP BLANK
Soil

BX79334
2/28/2017
TRIP BLANK HIGH
Soil

Project Id : ABC BARREL

CAS	Units	NJ-IGW Cleanup	NJ-Soil Res.	Result	RL	Qual	MDL	Result	RL	Qual	MDL	
Miscellaneous/Inorganics												
Percent Solid	PHNX - PCTSOLID	%										
Volatiles By SW8260C												
cis-1,2-Dichloroethene	156-59-2	ug/Kg	1,000	230,000	< 5.0	5.0	U	0.50	< 250	250	U	25
Tetrachloroethene	127-18-4	ug/Kg	1,000	2,000	< 5.0	5.0	U	1.0	< 250	250	U	50
Trichloroethene	79-01-6	ug/Kg	1,000	7,000	< 5.0	5.0	U	0.50	< 250	250	U	25
Vinyl chloride	75-01-4	ug/Kg	10,000	700	< 5.0	5.0	U	0.50	< 250	250	U	25

Result Detected 

RL Exceeds Criteria 

Result Exceeds Criteria 



Lab Sample Id
Collection Date
Client Id
Matrix

BX87625
3/15/2017
RA-2B
Soil

BX87626
3/15/2017
RA-2B DUP
Soil

Project Id : ABC BARREL

	CAS	Units	NJ-IGW Soil Scrn	NJ-Soil Res.	Result	RL	Qual	MDL	Result	RL	Qual	MDL
Miscellaneous/Inorganics												
Percent Solid	PHNX - PCTSOLID	%			91				90			
Metals, Total												
Aluminum	7429-90-5	mg/Kg	6,000	78,000	7,410	39		7.7	8,360	33		6.7
Antimony	7440-36-0	mg/Kg	6	31	< 1.9	1.9	U	1.9	< 1.7	1.7	U	1.7
Arsenic	7440-38-2	mg/Kg	19	19	2.45	0.77		0.77	2.58	0.67		0.67
Barium	7440-39-3	mg/Kg	2,100	16,000	26.5	0.8		0.39	28.6	0.7		0.33
Beryllium	7440-41-7	mg/Kg	0.7	16	0.37	0.31		0.15	0.42	0.27		0.13
Cadmium	7440-43-9	mg/Kg	2	78	< 0.39	0.39	U	0.39	< 0.33	0.33	U	0.33
Calcium	7440-70-2	mg/Kg			232	3.9		3.6	255	3.3		3.1
Chromium	7440-47-3	mg/Kg			21.3	0.39		0.39	25.4	0.33		0.33
Cobalt	7440-48-4	mg/Kg	90	1,600	4.63	0.39		0.39	6.59	0.33		0.33
Copper	7440-50-8	mg/Kg	11,000	3,100	28.2	0.39		0.39	32.6	0.33		0.33
Iron	7439-89-6	mg/Kg			16,200	39		39	17,800	33		33
Lead	7439-92-1	mg/Kg	90	400	4.4	0.8		0.39	4.8	0.7		0.33
Magnesium	7439-95-4	mg/Kg			1,110	3.9		3.9	1,530	3.3		3.3
Manganese	7439-96-5	mg/Kg	65	11,000	54.1	0.39		0.39	76.9	0.33		0.33
Mercury	7439-97-6	mg/Kg	0.1	23	< 0.03	0.03	U	0.02	< 0.03	0.03	U	0.02
Nickel	7440-02-0	mg/Kg	48	1,600	10.6	0.39		0.39	14.2	0.33		0.33
Potassium	9/7/7440	mg/Kg			1,160	8		3.0	1,260	7		2.6
Selenium	7782-49-2	mg/Kg	11	390	< 1.5	1.5	U	1.3	< 1.3	1.3	U	1.1
Silver	7440-22-4	mg/Kg	1	390	< 0.39	0.39	U	0.39	< 0.33	0.33	U	0.33
Sodium	7440-23-5	mg/Kg			22	8	J	3.3	30	7	J	2.9
Thallium	7440-28-0	mg/Kg	3	5	< 1.5	1.5	U	1.5	< 1.3	1.3	U	1.3
Vanadium	7440-62-2	mg/Kg		78	31.7	0.39		0.39	30.5	0.33		0.33
Zinc	7440-66-6	mg/Kg	930	23,000	24.4	0.8		0.39	31.2	0.7		0.33
SVOA TICS												
2-Pentanone, 4-hydroxy-4-methyl- (RT 1.832)	123-42-2	ug/Kg			43,000	4	JNA					
2-Pentanone, 4-hydroxy-4-methyl- (RT 1.854)	123-42-2	ug/Kg							110,000	4	JNA	
3-Penten-2-one, 4-methyl- (RT 1.592)	141-79-7	ug/Kg							1,800	4	JNA	
Polynuclear Aromatic HC By SW8270D												
2-Methylnaphthalene	91-57-6	ug/Kg	8,000	230,000	< 350	350	UJ	110	< 360	360	UJ	110
Acenaphthene	83-32-9	ug/Kg	110,000	3,400,000	< 350	350	UJ	110	< 360	360	UJ	110
Acenaphthylene	208-96-8	ug/Kg			< 350	350	UJ	99	< 360	360	UJ	100
Anthracene	120-12-7	ug/Kg	2,400,000	17,000,000	< 350	350	UJ	120	< 360	360	UJ	120
Benz(a)anthracene	56-55-3	ug/Kg	800	600	< 350	350	UJ	120	< 360	360	UJ	120
Benzo(a)pyrene	50-32-8	ug/Kg	200	200	< 250	250	UJ	120	< 250	250	UJ	120
Benzo(b)fluoranthene	205-99-2	ug/Kg	2,000	600	< 350	350	UJ	120	< 360	360	UJ	120
Benzo(ghi)perylene	191-24-2	ug/Kg		380,000,000	< 350	350	UJ	120	< 360	360	UJ	120
Benzo(k)fluoranthene	207-08-9	ug/Kg	25,000	6,000	< 350	350	UJ	120	< 360	360	UJ	120
Chrysene	218-01-9	ug/Kg	80,000	62,000	< 350	350	UJ	120	< 360	360	UJ	120
Dibenz(a,h)anthracene	53-70-3	ug/Kg	800	200	< 250	250	UJ	120	< 250	250	UJ	120
Fluoranthene	206-44-0	ug/Kg	1,300,000	2,300,000	< 350	350	UJ	120	< 360	360	UJ	120
Fluorene	86-73-7	ug/Kg	170,000	2,300,000	< 350	350	UJ	120	< 360	360	UJ	120
Indeno(1,2,3-cd)pyrene	193-39-5	ug/Kg	7,000	600	< 350	350	UJ	120	< 360	360	UJ	120
Naphthalene	91-20-3	ug/Kg	25,000	6,000	< 350	350	UJ	100	< 360	360	UJ	100
Phenanthrene	85-01-8	ug/Kg			< 350	350	UJ	100	< 360	360	UJ	100
Pyrene	129-00-0	ug/Kg	840,000	1,700,000	< 350	350	UJ	120	< 360	360	UJ	120

Result Detected

RL Exceeds Criteria

Result Exceeds Criteria



Lab Sample Id
Collection Date
Client Id
Matrix

BX96078
3/28/2017
RA-1B
Soil

Project Id : ABC BARREL

	CAS	Units	NJ-IGW Cleanup	NJ-Soil Res.	Result	RL	Qual	MDL
Miscellaneous/Inorganics								
Percent Solid	PHNX - PCTSOLID	%			87			
Metals, Total								
Aluminum	7429-90-5	mg/Kg		78,000	7,130	37		7.4
Antimony	7440-36-0	mg/Kg		31	< 1.8	1.8	U	1.8
Arsenic	7440-38-2	mg/Kg		19	< 0.74	0.74	U	0.74
Barium	7440-39-3	mg/Kg		16,000	14.5	0.7		0.37
Beryllium	7440-41-7	mg/Kg		16	0.29	0.29		0.15
Cadmium	7440-43-9	mg/Kg		78	< 0.37	0.37	U	0.37
Calcium	7440-70-2	mg/Kg			124	3.7		3.4
Chromium	7440-47-3	mg/Kg			14.4	0.37		0.37
Cobalt	7440-48-4	mg/Kg		1,600	9.69	0.37		0.37
Copper	7440-50-8	mg/kg		3,100	37.6	0.37		0.37
Iron	7439-89-6	mg/Kg			6,340	3.7		3.7
Lead	7439-92-1	mg/Kg		400	1.5	0.7		0.37
Magnesium	7439-95-4	mg/Kg			1,190	3.7		3.7
Manganese	7439-96-5	mg/Kg		11,000	162	3.7		3.7
Mercury	7439-97-6	mg/Kg		23	< 0.03	0.03	U	0.02
Nickel	7440-02-0	mg/Kg		1,600	14.6	0.37		0.37
Potassium	9/7/7440	mg/Kg			1,050	7		2.9
Selenium	7782-49-2	mg/Kg		390	< 1.5	1.5	U	1.3
Silver	7440-22-4	mg/Kg		390	< 0.37	0.37	U	0.37
Sodium	7440-23-5	mg/Kg			10	7		3.2
Thallium	7440-28-0	mg/Kg		5	< 1.5	1.5	U	1.5
Vanadium	7440-62-2	mg/Kg		78	8.85	0.37		0.37
Zinc	7440-66-6	mg/Kg		23,000	50.1	0.7		0.37
SVOA TICS								
2-Pentanone, 4-hydroxy-4-methyl- (RT 2.157)	123-42-2	ug/Kg			60,000	4	JNA	
Polynuclear Aromatic HC By SW8270D								
2-Methylnaphthalene	91-57-6	ug/Kg		230,000	< 380	380	UJ	110
Acenaphthene	83-32-9	ug/Kg	100,000	3,400,000	< 380	380	UJ	110
Acenaphthylene	208-96-8	ug/Kg			< 380	380	UJ	110
Anthracene	120-12-7	ug/Kg	100,000	17,000,000	< 380	380	UJ	120
Benz(a)anthracene	56-55-3	ug/Kg	500,000	600	< 380	380	UJ	130
Benzo(a)pyrene	50-32-8	ug/Kg	100,000	200	< 260	380	UJ	120
Benzo(b)fluoranthene	205-99-2	ug/Kg	50,000	600	< 380	380	UJ	130
Benzo(ghi)perylene	191-24-2	ug/Kg		380,000,000	< 380	380	UJ	120
Benzo(k)fluoranthene	207-08-9	ug/Kg	500,000	6,000	< 380	380	UJ	130
Chrysene	218-01-9	ug/Kg	500,000	62,000	< 380	380	UJ	130
Dibenz(a,h)anthracene	53-70-3	ug/Kg	100,000	200	< 260	380	UJ	120
Fluoranthene	206-44-0	ug/Kg	100,000	2,300,000	< 380	380	UJ	120
Fluorene	86-73-7	ug/Kg	100,000	2,300,000	< 380	380	UJ	120
Indeno(1,2,3-cd)pyrene	193-39-5	ug/Kg	500,000	600	< 380	380	UJ	130
Naphthalene	91-20-3	ug/Kg	100,000	6,000	< 380	380	UJ	110
Phenanthrene	85-01-8	ug/Kg			< 380	380	UJ	110
Pyrene	129-00-0	ug/Kg	100,000	1,700,000	< 380	380	UJ	130

Result Detected

RL Exceeds Criteria

Result Exceeds Criteria



Lab Sample Id
Collection Date
Client Id
Matrix

BX96643
3/30/2017
RA-3B
Soil

Project Id : ABC BARREL

	CAS	Units	NJ-IGW Cleanup	NJ-IGW Soil Scrn	NJ-Soil Res.	Result	RL	Qual	MDL
Miscellaneous/Inorganics									
Percent Solid	PHNX - PCTSOLID	%				89			
Metals, Total									
Aluminum	7429-90-5	mg/Kg		6,000	78,000	10,300	37		7.5
Antimony	7440-36-0	mg/Kg		6	31	< 1.9	1.9	U	1.9
Arsenic	7440-38-2	mg/Kg		19	19	8.41	0.75		0.75
Barium	7440-39-3	mg/Kg		2,100	16,000	24.4	0.7		0.37
Beryllium	7440-41-7	mg/Kg		0.7	16	0.74	0.30		0.15
Cadmium	7440-43-9	mg/Kg		2	78	< 0.37	0.37	U	0.37
Calcium	7440-70-2	mg/Kg				349	3.7		3.4
Chromium	7440-47-3	mg/Kg				24.1	0.37		0.37
Cobalt	7440-48-4	mg/Kg		90	1,600	6.67	0.37		0.37
Copper	7440-50-8	mg/kg		11,000	3,100	7.96	0.37		0.37
Iron	7439-89-6	mg/Kg				24,300	37		37
Lead	7439-92-1	mg/Kg		90	400	5.1	0.7		0.37
Magnesium	7439-95-4	mg/Kg				2,490	3.7		3.7
Manganese	7439-96-5	mg/Kg		65	11,000	461	3.7		3.7
Mercury	7439-97-6	mg/Kg		0.1	23	< 0.03	0.03	U	0.02
Nickel	7440-02-0	mg/Kg		48	1,600	10.2	0.37		0.37
Potassium	9/7/7440	mg/Kg				3,060	7		2.9
Selenium	7782-49-2	mg/Kg		11	390	< 1.5	1.5	U	1.3
Silver	7440-22-4	mg/Kg		1	390	< 0.37	0.37	U	0.37
Sodium	7440-23-5	mg/Kg				28	7		3.2
Thallium	7440-28-0	mg/Kg		3	5	< 1.5	1.5	U	1.5
Vanadium	7440-62-2	mg/Kg			78	30.8	0.37		0.37
Zinc	7440-66-6	mg/Kg		930	23,000	35	0.7		0.37
Polynuclear Aromatic HC By SW8270D									
2-Methylnaphthalene	91-57-6	ug/Kg		8,000	230,000	< 370	370	UJ	110
Acenaphthene	83-32-9	ug/Kg	100,000	110,000	3,400,000	< 370	370	U	110
Acenaphthylene	208-96-8	ug/Kg				< 370	370	UJ	100
Anthracene	120-12-7	ug/Kg	100,000	2,400,000	17,000,000	< 370	370	U	120
Benz(a)anthracene	56-55-3	ug/Kg	500,000	800	600	< 370	370	U	120
Benzo(a)pyrene	50-32-8	ug/Kg	100,000	200	200	< 260	260	UJ	120
Benzo(b)fluoranthene	205-99-2	ug/Kg	50,000	2,000	600	< 370	370	U	130
Benzo(ghi)perylene	191-24-2	ug/Kg			380,000,000	< 370	370	U	120
Benzo(k)fluoranthene	207-08-9	ug/Kg	500,000	25,000	6,000	< 370	370	U	120
Chrysene	218-01-9	ug/Kg	500,000	80,000	62,000	< 370	370	U	120
Dibenz(a,h)anthracene	53-70-3	ug/Kg	100,000	800	200	< 260	260	U	120
Fluoranthene	206-44-0	ug/Kg	100,000	1,300,000	2,300,000	< 370	370	U	120
Fluorene	86-73-7	ug/Kg	100,000	170,000	2,300,000	< 370	370	U	120
Indeno(1,2,3-cd)pyrene	193-39-5	ug/Kg	500,000	7,000	600	< 370	370	U	120
Naphthalene	91-20-3	ug/Kg	100,000	25,000	6,000	< 370	370	UJ	110
Phenanthrene	85-01-8	ug/Kg				< 370	370	U	110
Pyrene	129-00-0	ug/Kg	100,000	840,000	1,700,000	< 370	370	U	130

Result Detected

RL Exceeds Criteria

Result Exceeds Criteria